

# Magellan™ 1500i Omni-Directional Imaging Scanner



**Product Reference Guide**

**Datalogic S.r.l.**

Via S. Vitalino, 13  
40012 Calderara di Reno — Italy  
Tel. +39 051 3147011  
Fax +39 051 3147205

©2018-2019 Datalogic S.p.A. and/or its affiliates

An Unpublished Work - All rights reserved. No part of the contents of this documentation or the procedures described therein may be reproduced or transmitted in any form or by any means without prior written permission of Datalogic S.p.A. and/or its affiliates. Owners of Datalogic products are hereby granted a non-exclusive, revocable license to reproduce and transmit this documentation for the purchaser's own internal business purposes. Purchaser shall not remove or alter any proprietary notices, including copyright notices, contained in this documentation and shall ensure that all notices appear on any reproductions of the documentation.

Should future revisions of this manual be published, you can acquire printed versions by contacting your Datalogic representative. Electronic versions may either be downloadable from the Datalogic website ([www.datalogic.com](http://www.datalogic.com)) or provided on appropriate media. If you visit our website and would like to make comments or suggestions about this or other Datalogic publications, please let us know via the "Contact Datalogic" page.

**Disclaimer**

Datalogic has taken reasonable measures to provide information in this manual that is complete and accurate, however, Datalogic reserves the right to change any specification at any time without prior notice.

Datalogic and the Datalogic logo are registered trademarks of Datalogic S.p.A. in many countries, including the U.S.A. and the E.U.

Magellan is a trademark of Datalogic S.p.A. or of Datalogic and/or its affiliates, registered in many countries, including the U.S. and the E.U.

**Patents**

See [www.patents.datalogic.com](http://www.patents.datalogic.com) for patent list.



# Table of Contents

<b>Chapter 1. INTRODUCTION</b> .....	<b>1</b>
<b>About This Manual</b> .....	<b>1</b>
Manual Conventions .....	1
<b>Connecting the Scanner</b> .....	<b>2</b>
Optional Stand/Riser .....	4
Removing the Stand/Bottom Cover .....	4
Magnetic Base Mounting .....	4
<b>How to Scan</b> .....	<b>5</b>
Handheld Scanning Mode .....	5
Center Zone Qualification .....	5
<b>Cleaning</b> .....	<b>6</b>
Manufacturer Approved Cleaning Materials .....	6
Do Not Use Abrasive Cleansers! .....	7
<b>Chapter 2. PROGRAMMING</b> .....	<b>8</b>
<b>About Programming your Scanner</b> .....	<b>8</b>
Programming with Barcodes .....	9
Getting Started .....	10
Programming Mode .....	10
Programming Session .....	11
If You Make a Mistake... ..	12
Return to Factory Settings .....	12
Datalogic Scanalyzer .....	13
Service Port Mode .....	14
<b>GENERAL SCANNER FEATURES</b> .....	<b>15</b>
<b>1D Double Read Timeout</b> .....	<b>16</b>
<b>2D Double Read Timeout</b> .....	<b>17</b>
<b>Double Read Table Size</b> .....	<b>18</b>
<b>Digital Watermark (Digimarc) Features</b> .....	<b>19</b>
Digital Watermark (Digimarc) Enable .....	19
Digital Watermark (Digimarc) Double Read Timeout .....	20
Digital Watermark (Digimarc) Data Format .....	21
<b>1D Inverse Read Control</b> .....	<b>22</b>
<b>2D Inverse Read Control</b> .....	<b>23</b>
<b>Handheld State</b> .....	<b>24</b>
<b>Center Zone Enable</b> .....	<b>25</b>
<b>Center Zone Size</b> .....	<b>26</b>
<b>Sleep Mode Timer</b> .....	<b>27</b>
<b>Accelerometer Detect Threshold</b> .....	<b>28</b>
<b>Accelerometer Reject Threshold</b> .....	<b>29</b>
<b>Accelerometer Delay To Stationary</b> .....	<b>30</b>
<b>Accelerometer Inmotion Threshold</b> .....	<b>31</b>
<b>Power On Alert</b> .....	<b>32</b>
<b>External Read Indicator (ERI)</b> .....	<b>33</b>
<b>ERI Timeout</b> .....	<b>34</b>
<b>Good Read LED Idle State</b> .....	<b>35</b>
<b>Scanner Control Button Options</b> .....	<b>36</b>
<b>Good Read Beep Control</b> .....	<b>37</b>
<b>Good Read Beep Frequency</b> .....	<b>38</b>

Good Read Beep Length .....	39
Good Read Beep Volume .....	40
Good Read When to Indicate .....	41
Illumination During Disable Mode .....	42
Object Sense Control .....	43
Reading Illumination Duration .....	44
Illumination Blank on Beep .....	45
Green Spot Duration Time .....	46
<b>IMAGING FEATURES.....</b>	<b>47</b>
<b>Imaging Features .....</b>	<b>48</b>
Image Capture to the Host by Host Command .....	48
Image Destination .....	49
Picture Retrieval Timeout .....	50
Image Capture Delay .....	52
Image Format .....	53
Image Size .....	54
Image Brightness .....	55
Image Contrast .....	57
Image Compression .....	59
Region of Interest (ROI) .....	60
Number of Imager Frames .....	62
<b>Cell Phone Settings .....</b>	<b>63</b>
Cell Phone Mode .....	63
Cell Mode Percent .....	64
<b>INTERFACE RELATED FEATURES.....</b>	<b>65</b>
<b>Interface Type .....</b>	<b>66</b>
USB Interface Selection .....	67
RS-232 Interface Selection .....	68
Maximum Host-Transmitted Message Length .....	69
Ignore Host Commands .....	70
<b>USB Interface Features .....</b>	<b>71</b>
USB-COM Interface Setup .....	71
USB Power Compliance .....	71
USB Keyboard Features .....	72
Keyboard Layout .....	72
USB Keyboard Country Mode .....	72
USB Keyboard Caps Lock State .....	75
USB Keyboard Send Control Characters .....	76
USB Keyboard Intercharacter Delay .....	77
USB Keyboard Additional Interface Options .....	78
USB-OEM Features .....	79
USB OEM Scanner Device Type .....	79
USB OEM Additional Interface Options .....	80
<b>RS-232 Interface Features .....</b>	<b>81</b>
RS-232 Baud Rate .....	81
RS-232 Number of Data Bits .....	83
RS-232 Number of Stop Bits .....	83
RS-232 Parity .....	84
RS-232 Hardware Control .....	85
RS-232 Intercharacter Delay .....	86
RS-232 Software Flow Control .....	87
RS-232 Beep on ASCII BEL .....	88
Beep on Not on File .....	88
RS-232 ACK NAK Features .....	89

ACK NAK Enable .....	89
RS-232 ACK Character .....	90
RS-232 NAK Character .....	91
RS-232 Retry on ACK NAK Timeout .....	92
RS-232 ACK NAK Timeout Value .....	93
RS-232 ACK NAK Retry Count .....	94
RS-232 ACK NAK Error Handling .....	95
RS-232 Indicate Transmission Failure .....	96
<b>DATA EDITING .....</b>	<b>97</b>
<b>Data Editing Overview .....</b>	<b>98</b>
Please Keep In Mind... .....	98
<b>Global Prefix/Suffix .....</b>	<b>99</b>
Global Prefix .....	99
Global Suffix .....	100
<b>AIM ID .....</b>	<b>101</b>
<b>Label ID .....</b>	<b>102</b>
Label ID Control .....	102
Setting Label ID .....	103
1D Symbologies - Label ID .....	104
2D Symbologies .....	110
Postal Codes .....	112
Global Mid-Label ID .....	113
<b>Case Conversion .....</b>	<b>114</b>
<b>Character Conversion .....</b>	<b>115</b>
<b>1D SYMBOLOGY PROGRAMMING.....</b>	<b>116</b>
<b>1D Symbologies .....</b>	<b>116</b>
<b>Coupon Control .....</b>	<b>117</b>
Coupon Control Enable .....	117
Coupon Label Priority Timer .....	119
<b>UPC-A .....</b>	<b>120</b>
UPC-A Enable .....	120
UPC-A Number System Character Transmission .....	121
UPC-A Check Character Transmission .....	122
UPC-A Minimum Read .....	123
Expand UPC-A to EAN-13 .....	124
<b>UPC-E .....</b>	<b>125</b>
UPC-E Enable .....	125
UPC-E Number System Character Transmission .....	126
UPC-E Check Character Transmission .....	127
Expand UPC-E to UPC-A .....	128
Expand UPC-E to EAN-13 .....	129
UPC-E Minimum Read .....	130
<b>EAN-13 .....</b>	<b>131</b>
EAN-13 Enable .....	131
EAN-13 First Character Transmission .....	132
EAN-13 Check Character Transmission .....	133
EAN-13 ISBN Conversion Enable .....	134
EAN-13 Minimum Read .....	135
<b>EAN-8 .....</b>	<b>136</b>
EAN-8 Enable .....	136
EAN-8 Check Character Transmission .....	137
Expand EAN-8 to EAN-13 .....	138
EAN-8 Minimum Read .....	139
EAN-8 Guard Insertion .....	140

EAN-8 Guard Substitution .....	141
EAN-8/Jan-8 Both Guards Substitution .....	142
EAN-8 Stitch Exact Label Halves .....	143
EAN-8 Stitch Unlike Label Halves .....	144
EAN-8 Minimum Segment Length .....	145
EAN-8 Decoding Levels .....	147
<b>Other UPC/EAN Options .....</b>	<b>148</b>
In-Store Printed Label Minimum Read .....	149
UPC/EAN Correlation .....	150
UPC/EAN Guard Insertion .....	151
UPC/EAN Stitch Exact Label Halves .....	152
UPC/EAN Stitch Unlike Label Halves .....	153
UPC/EAN Minimum Segment Length .....	154
Price Weight Check .....	156
Enable EAN Two Label .....	158
EAN Two Label Minimum Read .....	159
EAN Two Label Combined Transmission .....	160
Add-ons .....	161
P2 Add-on Minimum Read .....	162
P5 Add-on Minimum Read .....	165
UPC/EAN Composites .....	168
<b>GTIN .....</b>	<b>169</b>
GTIN Enable .....	169
<b>GS1 DataBar .....</b>	<b>170</b>
<b>DataBar Omnidirectional .....</b>	<b>170</b>
DataBar Omnidirectional Enable .....	170
DataBar Omnidirectional/EAN-128 Emulation .....	171
DataBar Omnidirectional 2D Component Enable .....	172
DataBar Omnidirectional Minimum Read .....	173
DataBar Omnidirectional Double Read Timeout .....	174
<b>DataBar Limited .....</b>	<b>175</b>
DataBar Limited Enable .....	175
DataBar Limited Minimum Read .....	176
DataBar Limited 2D Component Enable .....	177
DataBar Limited EAN128 Emulation Enable .....	178
<b>DataBar Expanded .....</b>	<b>179</b>
DataBar Expanded Enable .....	179
DataBar Expanded EAN-128 Emulation .....	180
DataBar Expanded 2D Component Enable .....	181
DataBar Expanded Minimum Read .....	182
DataBar Expanded Length Control .....	183
DataBar Expanded Length 1 .....	184
DataBar Expanded Length 2 .....	185
DataBar Expanded Reverse Retry .....	186
<b>Code 39 .....</b>	<b>187</b>
Code 39 Enable .....	187
Code 39 Start Stop Character Transmission .....	188
Code 39 Check Character Calculation .....	189
Code 39 Check Character Transmission .....	190
Code 39 Full ASCII .....	191
Code 39 Minimum Read .....	192
Code 39 Length Control .....	193
Code 39 Length 1 .....	194
Code 39 Length 2 .....	195
Code 39 Stitching .....	196

Code 39 Require Margins .....	197
<b>Code 32 Italian Pharmacode .....</b>	<b>198</b>
Code 32 Italian Pharmacode Enable .....	198
Code 32 Start Stop Character Transmission .....	199
Code 32 Check Character Transmission .....	200
<b>Code 128 .....</b>	<b>201</b>
Code 128 Enable .....	201
Code 128 Transmit Function Characters .....	202
Expand Code128 to Code 39 .....	203
Code 128 Minimum Read .....	204
Code 128 Length Control .....	205
Code 128 Length 1 .....	206
Code 128 Length 2 .....	207
Code 128 Stitching .....	208
<b>EAN-128 .....</b>	<b>209</b>
EAN-128 Enable .....	209
<b>Interleaved 2 of 5 (I 2 OF 5) .....</b>	<b>210</b>
Interleaved 2 of 5 (I 2 OF 5) Enable .....	210
I 2 of 5 Check Character Calculation .....	211
I 2 of 5 Check Character Transmission .....	212
I 2 of 5 Minimum Read .....	213
I 2 of 5 Length Control .....	214
I 2 of 5 Length 1 .....	215
I 2 of 5 Length 2 .....	216
<b>Codabar .....</b>	<b>217</b>
Codabar Enable .....	217
Codabar Start Stop Character Transmission .....	218
Codabar Start Stop Character Set .....	219
Codabar Start Stop Character Match .....	220
Codabar Check Character Calculation .....	221
Codabar Check Character Transmission .....	222
Codabar Minimum Read .....	223
Codabar Length Control .....	224
Codabar Length 1 .....	225
Codabar Length 2 .....	226
Codabar Require Margins .....	227
<b>Code 93 .....</b>	<b>228</b>
Code 93 Enable .....	228
Code 93 Minimum Read .....	229
Code 93 Length Control .....	230
Code 93 Length 1 .....	231
Code 93 Length 2 .....	232
<b>MSI .....</b>	<b>233</b>
MSI Enable .....	233
MSI Check Character Calculation .....	234
MSI Number of Check Characters .....	235
MSI Check Character Transmission .....	236
MSI Minimum Read .....	237
MSI Length Control .....	238
MSI Length 1 .....	239
MSI Length 2 .....	240
<b>Standard 2 of 5 .....</b>	<b>241</b>
Standard 2 of 5 Enable .....	241
Standard 2 of 5 Check Character Calculation .....	242
Standard 2 of 5 Check Character Transmission .....	243

Standard 2 of 5 Minimum Read .....	244
Standard 2 of 5 Correlation .....	245
Standard 2 of 5 Length Control .....	246
Standard 2 of 5 Length 1 .....	247
Standard 2 of 5 Length 2 .....	248
<b>2D SYMBOLOGIES/POSTAL CODES .....</b>	<b>249</b>
<b>Data Matrix .....</b>	<b>250</b>
Data Matrix Enable .....	250
Data Matrix Length Control .....	251
Configuring Variable Length Decoding: .....	251
Data Matrix Length 1, Length 2 Programming Instructions .....	252
GS1 Datamatrix Enable .....	253
<b>PDF 417 .....</b>	<b>254</b>
PDF 417 Enable .....	254
PDF 417 Length Control .....	255
Configuring Variable Length Decoding: .....	255
PDF 417 Length 1, Length 2 Programming Instructions .....	256
PDF 417 Read Option .....	257
<b>Micro PDF 417 .....</b>	<b>258</b>
Micro PDF 417 Enable .....	258
Micro PDF 417 Length Control .....	259
Configuring Variable Length Decoding: .....	259
Micro PDF 417 Length 1, Length 2 Programming Instructions .....	260
Micro PDF 417 128 Emulation .....	261
<b>QR Code .....</b>	<b>262</b>
QR Code Enable .....	262
QR Code Length Control .....	263
Configuring Variable Length Decoding: .....	263
QR Code Length 1, Length 2 Programming Instructions .....	264
QR Code URL Link Enable .....	265
<b>GS1 QR Code Enable .....</b>	<b>266</b>
<b>Micro QR Code .....</b>	<b>267</b>
Micro QR Code Enable .....	267
Micro QR Code Length Control .....	268
Configuring Variable Length Decoding: .....	268
Micro QR Code Length 1, Length 2 Programming Instructions .....	269
<b>Aztec Code .....</b>	<b>270</b>
Aztec Enable .....	270
Aztec Length Control .....	271
Configuring Variable Length Decoding: .....	271
Aztec Length 1, Length 2 Programming Instructions .....	272
<b>Han Xin Code .....</b>	<b>273</b>
Han Xin Enable .....	273
<b>Postnet .....</b>	<b>274</b>
Postnet Enable .....	274
<b>Planet Code .....</b>	<b>275</b>
Planet Code Enable .....	275
<b>Royal Mail .....</b>	<b>276</b>
Royal Mail Enable .....	276
<b>Kix .....</b>	<b>277</b>
Kix Enable .....	277
<b>Australia Post .....</b>	<b>278</b>
Australian Post Enable .....	278
<b>Japan Post .....</b>	<b>279</b>
Japan Post Enable .....	279



IMB .....	280
IMB Enable .....	280
Sweden Post .....	281
Sweden Post Enable .....	281
Portugal Post .....	282
Portugal Post Enable .....	282
<b>Chapter 3. REFERENCES .....</b>	<b>283</b>
Global Prefix/Suffix .....	283
Label ID .....	284
Label ID .....	285
Length Control .....	288
Configuring Fixed Length Decoding: .....	288
Configuring Variable Length Decoding: .....	288
Length 1, Length 2 Programming Instructions .....	288
<b>Appendix A. PRODUCT SPECIFICATIONS .....</b>	<b>289</b>
Decoding Capability .....	289
Electrical .....	289
Environmental .....	290
Interfaces .....	290
Optional Features .....	290
Physical Characteristics .....	290
Reading Performance .....	291
Reading Ranges .....	291
Safety & Regulatory .....	291
Utilities .....	292
Warranty .....	292
LED and Beeper Indicators .....	293
Error Codes .....	294
<b>Appendix B. CABLE PINOUTS .....</b>	<b>295</b>
Standard Cable Pinouts (Primary Interface Cables) .....	295
<b>Appendix C. ALPHA-NUMERIC KEYPAD.....</b>	<b>296</b>
<b>Appendix D. FACTORY DEFAULT SETTINGS .....</b>	<b>298</b>
Factory Default Settings .....	298
<b>Appendix E. KEYBOARD FUNCTION KEY MAPPINGS.....</b>	<b>311</b>
USB Function Key Usage Map .....	311
Scanset 1 Function Key Map .....	312
Scanset 2 Function Key Map .....	312
Scanset 3, 102-Key Function Key Map .....	313
Scanset 3 122-Key Function Key Map .....	314
Japanese DOS Function Key Map .....	315
NEC 9801-Key Function Key Map .....	316
<b>Appendix F. HOST COMMANDS.....</b>	<b>317</b>
Accepting RS-232 and USB COM Commands .....	317
<b>Appendix G. SAMPLE SYMBOLS.....</b>	<b>318</b>
1D Symbol Samples .....	318
2D Sample Symbols .....	320
Composite Sample Symbols .....	321

---

# NOTES



# Chapter 1

## Introduction

The Magellan™ 1500i Scanner is designed for small counter retail checkout environments where there is a relatively high number of transactions with a fairly small number of items per transaction. The scanner has a reduced footprint, allowing more room for item merchandising of high margin impulse items clustered around the POS (Point of Sale).

The Magellan 1500i uses intelligent illumination technology to optimize light levels for a variety of barcode scanner functions including automatic reading of barcodes from printed surfaces, mobile devices and image capture in variable contrast environments.

### About This Manual

This manual provides advanced user information, including connection, programming, product and cable specifications, and other useful references. For additional information, such as installation, maintenance, troubleshooting and warranty information, see the Quick Reference Guide (QRG). Copies of other publications for this product are downloadable free of charge from the Datalogic website at [www.datalogic.com](http://www.datalogic.com).

On leaving the factory, units are programmed for the most common terminal and communications settings. If you need to change these settings, custom programming can be accomplished by scanning the barcodes in this guide.

### Manual Conventions

The symbols listed below are used in this manual to notify the reader of key issues or procedures that must be observed when using the scanner:



**NOTE**

**Notes contain information necessary for properly diagnosing, repairing and operating the scanner.**



**CAUTION**

**The CAUTION symbol advises you of actions that could damage equipment or property.**

## Connecting the Scanner

The scanner kit you ordered to match your interface should provide a compatible cable for your installation. Alternatively, if your scanner receives Power Off the Terminal (POT) it might be possible to connect using a cable from a previously existing installation (except for USB). Check with your technical support representative about compatibility before connecting. Use the appropriate instructions below when you're ready to connect the scanner to the terminal, PC or other host device.

Upon completing the connection via the appropriate interface instructions below, proceed to the [Interface Related Features](#) section of this manual and scan the barcode to select the correct interface type.

**RS-232 Serial Connection** — Turn off power to the terminal/PC and connect the scanner to the terminal/PC serial port via the RS-232 cable as shown in [Figure 1](#). If the terminal will not support POT (Power Off the Terminal) to supply scanner power, use the approved power supply (AC Adapter).

**Figure 1. Connecting the Scanner**

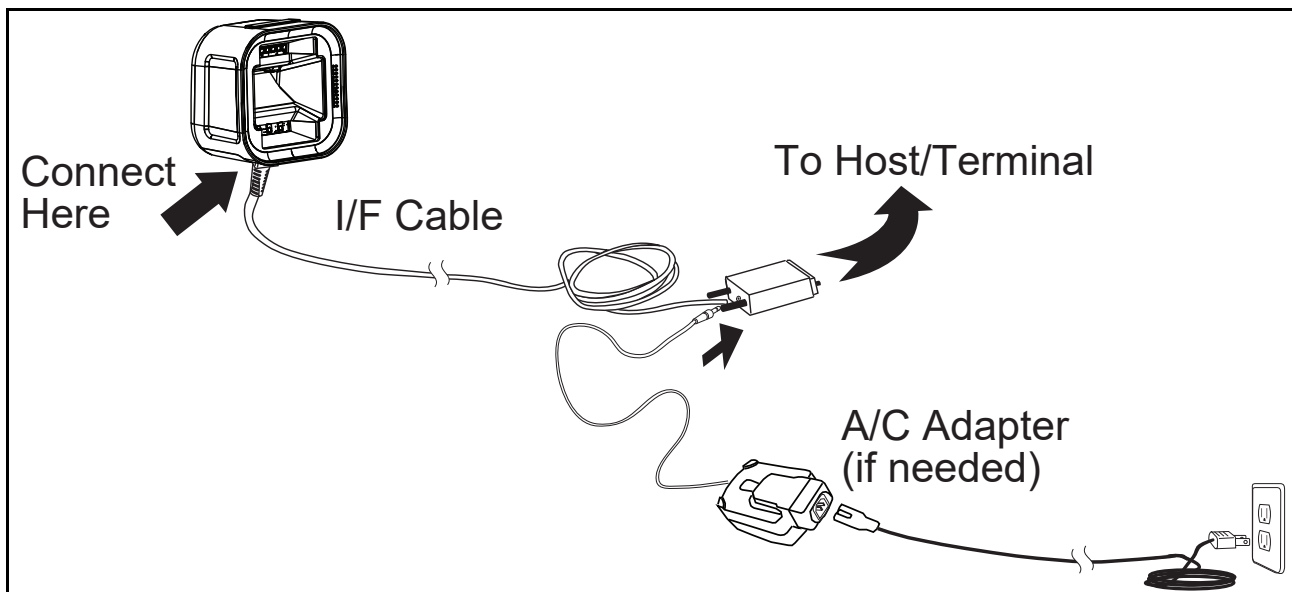

**USB Connection** — Connect the scanner to a USB port on the terminal/PC using the correct USB cable for the interface type you ordered. Reference [Figure 1](#) on page 2.

Figure 2. Scanner Features - Front View

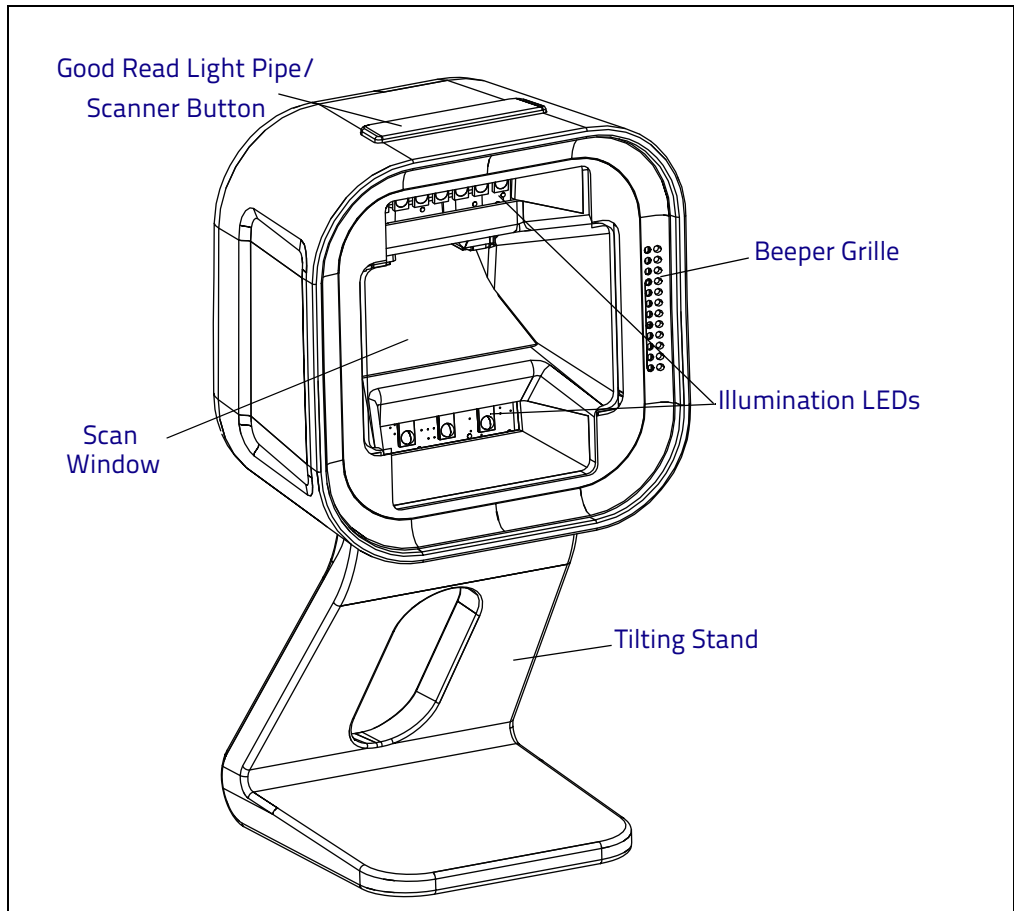
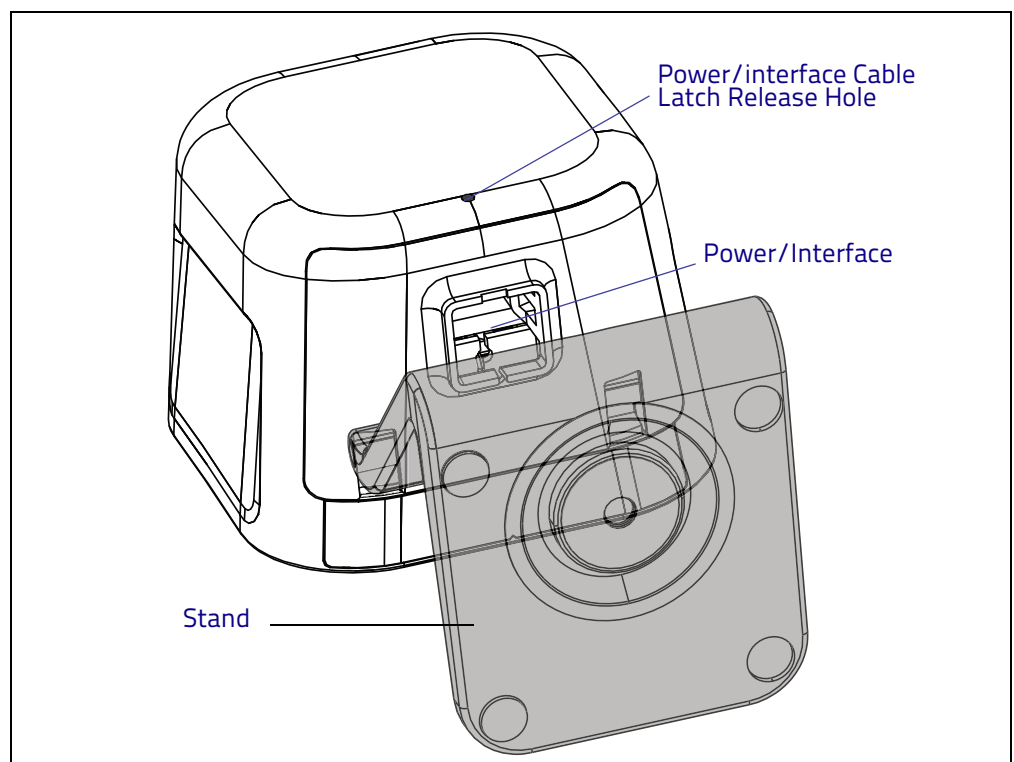

Figure 3. Scanner Features - Bottom View



## Optional Stand/Riser

An optional stand / riser is available for the scanner. The stand and riser have anti-skid pads on the bottom and can rest on any desired horizontal surface or countertop. The scanner (along with the stand/riser) can be easily repositioned on the counter or lifted for portable use.

### Removing the Stand/Bottom Cover



**CAUTION**

**Do not attempt to remove the Stand without first unplugging the Cable as described. Doing so may result in damage to the scanner.**

1. Unplug the Power Interface Cable by inserting a paper clip or similar object into the latch release hole as shown in Figure 2 on page 3.
2. After removing the Interface Cable, pull the bottom of the Stand forward (in the direction of the Front Window) to detach it from the unit. It will snap free easily if oriented correctly.

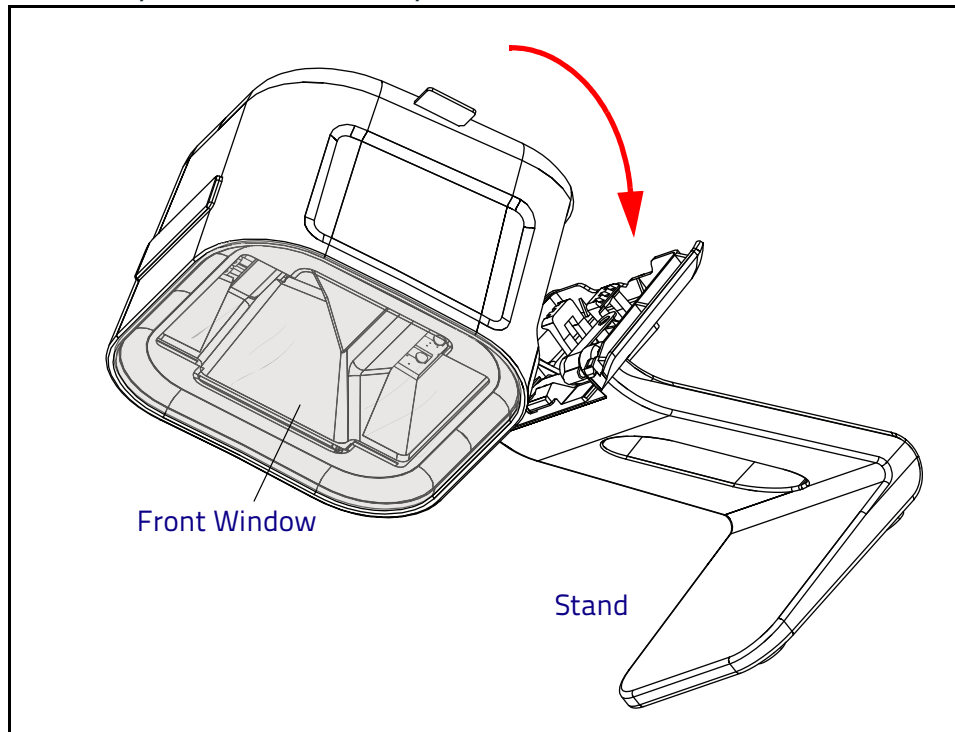

## Magnetic Base Mounting

The magnetic swivel base can be used to semi-permanently attach a scanner to a flat surface (vertical or horizontal), using the provided adhesive or screw. Both the stand and riser options mount onto the magnetic swivel base and are held magnetically in place. The scanner can easily be rotated to a desired orientation. The scanner (along with the riser or stand) can be detached for portable use by lifting the entire unit with the hand.

## How to Scan

Barcodes can be presented to the scanner while it is resting on the counter, or the scanner can be picked up for targeted scanning.

Figure 4. Scanning Methods

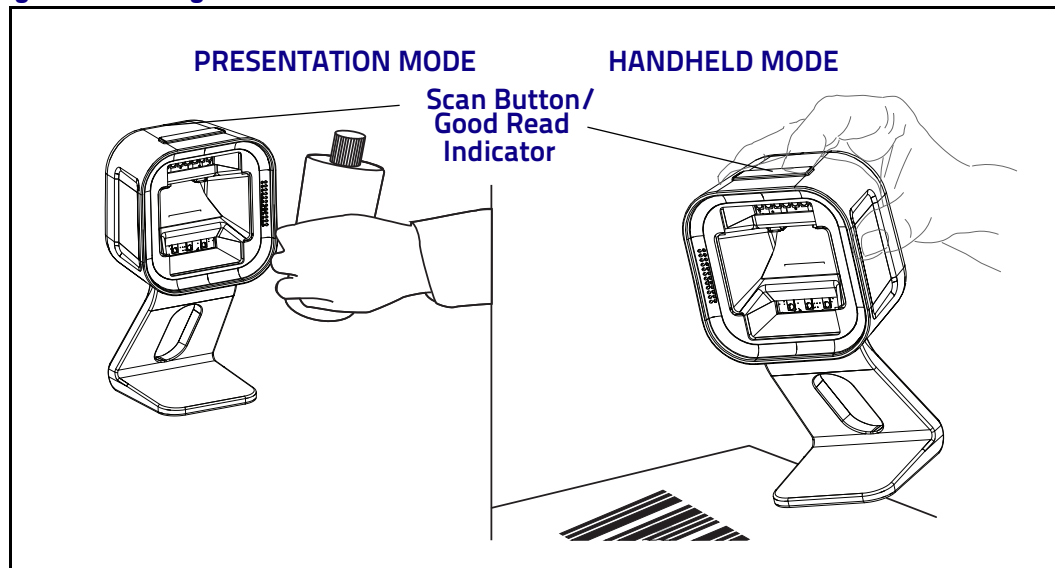

## Handheld Scanning Mode

To read a barcode using Handheld Scanning Mode:

1. Pick up the scanner – the aimer LED will illuminate automatically.
2. With the aimer over the barcode to be read, press and release the button.

Upon a successful read, the button will blink bright green and the GreenSpot™ will illuminate, indicating the barcode has been read.

See [Handheld State on page 24](#) for programming labels for this feature.

## Center Zone Qualification

The configurable Center Zone can be set to limit the scan area to allow Targeted Scanning of pick lists or other special items. Barcodes will read in any orientation. The scanner will return to full pattern Presentation Mode when set back down, after a configurable time has elapsed.

See [Center Zone Enable on page 25](#) to set this feature.

## Cleaning

Exterior surfaces and scan windows exposed to spills, smudges or debris accumulation require periodic cleaning to assure best performance during scanning. Use a clean, lint-free cloth or paper towel dampened with a nonabrasive, mild, water-based cleaner to wipe away stains, smudges, fingerprints, spills, etc. from the scan window and exterior surfaces.

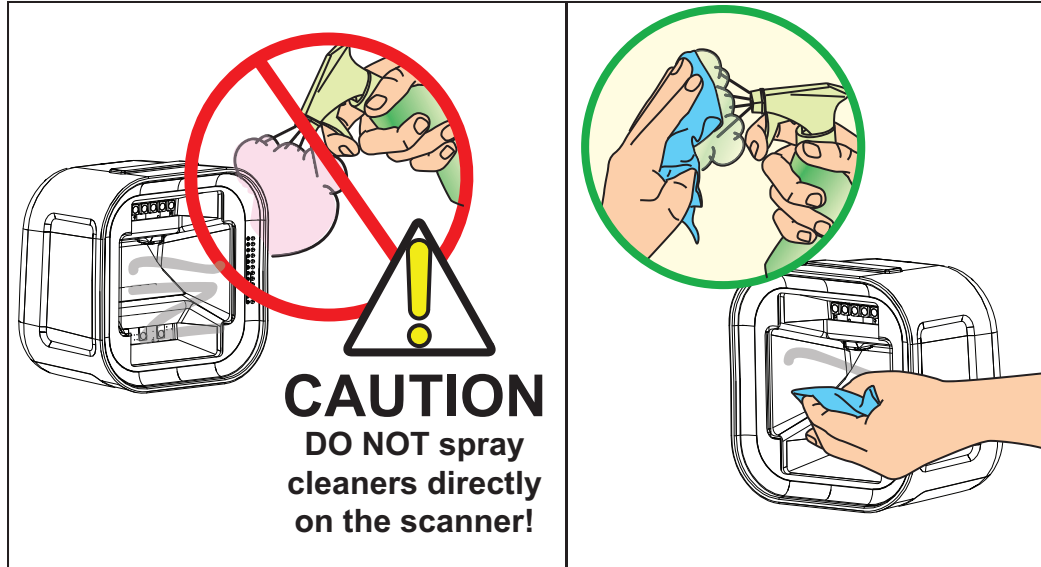

DO NOT use abrasive cleaning agents or abrasive pads to clean this product. Harsh chemicals, disinfectants, and cleansers can cause damage which will adversely affect scanning performance.

## Manufacturer Approved Cleaning Materials

Datalogic recommends the use of the following cleaners on its products.

	<b>APPROVED CLEANERS</b>
<ul style="list-style-type: none"><li>▪ Hydrogen Peroxide (not to exceed a 3% solution)</li><li>▪ Chlorine bleach (not to exceed a 0.25% solution)</li><li>▪ Mild detergent and water</li><li>▪ Isopropyl Alcohol (not to exceed a 70% solution)</li></ul>	



Use of the above cleaners *in combination with each other* is not recommended and may constitute a health hazard. Follow all specified safety precautions when using any cleaning solution.



## Do Not Use Abrasive Cleansers !

Under no circumstances should abrasive cleansers, abrasive pads, caustic solutions or other harsh chemicals, including those listed below, be used on any part of the scanner as they can cause damage which will adversely affect scanning performance. Use of such materials, either alone or in combination with other cleaning agents, will void the manufacturer's warranty.

	<b>!! DO NOT USE !!</b>
<ul style="list-style-type: none"><li>▪ Ammonia solutions</li><li>▪ Acetone</li><li>▪ Benzene</li><li>▪ Ethanolamine</li><li>▪ Ethers</li><li>▪ Ketones</li></ul>	<ul style="list-style-type: none"><li>▪ Trichloroethylene</li><li>▪ Toluene</li><li>▪ Carboic acid</li><li>▪ Aromatic or chlorinated hydrocarbons</li><li>▪ Aqueous or alcoholic alkaline solutions</li></ul>



# Chapter 2 Programming

## About Programming your Scanner

The scanner is typically factory-configured with a set of default features standard to the interface type you ordered. The scanner's programmable feature settings can be modified to accommodate your system's unique requirements. If you need to change these settings, custom programming can be accomplished using one of the following methods:

**Programming Barcodes** — The programming bar code labels contained in this manual will allow you to customize and configure features and settings for your scanner. Go to "Programming with Barcodes" on page 9 to get started.

**Scanalyzer Configuration Utility** — An additional programming option is to use Datalogic's Scanalyzer software configuration utility, available for free download from the Datalogic website. See "Datalogic Scanalyzer" on page 13 for more information.



### NOTE

When you program the scanner using either of the methods listed above, the scanner will store the changes until reprogrammed or returned to factory defaults.

## Programming with Barcodes

If you have little or no prior experience with programming using barcode labels, you should review the next few pages of this section to familiarize yourself with the basics of scanner programming before performing any changes to your configuration.

Most scanner programming falls within general categories:

**General Scanner Features** — features common to all interface types. Examples include beeper adjustments such as volume and length, read verification settings, etc.

**Imaging Features** — settings specific to Imaging

**Interface Related Features** — mandatory settings necessary to allow communication. Examples of these settings are: RS-232 baud rate and parity.



**Ensure that your planned modifications are compatible with the current interface.**

### NOTE

**Data Editing** — Additional information sent to the host computer along with the barcode data. This combination of barcode data and supplementary user-defined data is called a “message string.” The features in this chapter can be used to build specific user-defined data into a message string.

**Symbology Programming** — Gives the scanner the capability to autodiscriminate as few as one, and as many as all available symbologies. For optimal scanner performance enable only those symbologies required. Additionally the scanner may be programmed with the standard options available for the various symbologies, such as check digit, minimum label length, fixed and variable length bar codes, etc.

The barcode programming section lists the factory default settings for each of the menu commands for the standard RS-232 interface, indicated by a green arrow. Exceptions to default settings for the other interfaces can be found in [Appendix D, Factory Default Settings](#).

If you experience difficulties, have questions or require additional information, contact your local distributor, or call your dealer or sales representative.

## Getting Started

After scanning the interface barcode from the [Interface Related Features](#) section, you can select other options and customize your scanner through use of the instructions and programming barcodes available in that section and also the [Data Editing](#) and [1D Symbologies](#) chapters of this manual.



### NOTE

When you program the scanner using any of the methods above, the scanner will store the changes until reprogrammed or returned to factory defaults.

## Programming Mode

Scan the Enter/Exit Programming Mode barcode found at the top of applicable pages) once to enter Programming Mode. After the scanner is in Programming Mode, you can scan a number of parameter settings before scanning the Enter/Exit Programming Mode barcode a second time, which will then accept your changes, exit Programming Mode, reset the scanner and return it to normal operation.



### NOTE

While in Programming Mode, your scanner will read the 2D programming bar codes in this manual regardless of whether 2D reading capability has been enabled as an option.

The scanner will exit Programming Mode under any of the following conditions:

- the programming sequence has been completed or the Enter/Exit Programming Mode bar code is scanned.
- five minutes have passed without scanning activity. Any data programmed during the current session will be ignored, and the scanner will reset and revert to its condition previous to initiating the exited session.
- power is disconnected. Disconnecting power during Programming Mode, before scanning the Enter/Exit Programming Mode bar code, will cause all new settings to be ignored<sup>1</sup>. On powerup, the scanner will return to previous settings.

While in Programming Mode, the scanner only recognizes the special programming bar codes contained in this programming guide. See [Appendix A](#) for information about scanner indications while in the Programming Mode.

Some programming barcode labels, like the label [on page 14](#), require only the scan of that single label to enact the change. Most of the programming labels in this manual, however, require the scanner to be placed in Programming Mode prior to scanning them.

---

1. Exception: If an interface bar code had been read while in Programming Mode, the scanner will operate on the default settings for the new interface.

## Programming Session

A typical programming session is conducted as follows:

1. Scan the Enter/Exit Programming Mode bar code to place the scanner in Programming Mode. Depending upon its current programming, the scanner may emit a beep or beeps, indicating it has read the bar code and the green LED will flash on and off slowly while the scanner remains in Programming Mode. Normal scanning functions are disabled.

Scan the programming bar code(s) to make the desired changes. The beeper will sound as programming barcode labels are scanned, indicating progress during scanner configuration. The beep may vary depending upon the feature being configured.



### NOTE

**Not all features are available for all interfaces and the scanner will sound an error tone when scanning programming bar codes for features invalid to the current interface. Only features supported by the currently active interface will be implemented.**



### NOTE

**If a bar code is scanned that changes the scanner's interface, all previous configuration items scanned in the programming session are lost.**

Additionally, when programming a feature requiring you to scan single digits to set a multi-digit number, such as Minimum Label Length, do not scan bar code (or any item tag/item value bar code) before completing all input. To do so will result in an error tone and cause the scanner to exit Programming Mode. Under these circumstances, the current feature you were trying to set is not applied, but any previous bar codes scanned during the session will still take effect.



### NOTE

**It is recommended that programming sessions be limited to one feature at a time. Should you make a mistake in the programming sequence, it can be difficult to discover where an error has been made if several features are programmed at once. Additionally, it can be confusing to determine which features may or may not have been successfully set following such a session.**

2. Scan the Enter/Exit Programming Mode bar code to save any new settings and exit Programming Mode. The scanner will sound a beep and reset upon exiting Programming Mode, and the green LED will return to its usual state (on steady or off).
3. Maintain a good record of all changes made to ensure that you know if the original factory settings have been changed.

## If You Make a Mistake...

If, during a programming session, you find that you are unsure of the scanner's settings or wish to reset the scanner's configuration, use the Return to Factory Settings label below to return the scanner's configuration to the factory settings. Scanning this label will also reset any changes made during previous programming sessions.

### Return to Factory Settings

Scan the bar code below to return the scanner to the default settings configured at the factory for the currently active interface. This bar code is typically used to return the scanner to a "known" operating state when the present programming status is not known, faulty, or suspect.



**CAUTION**

**Use this bar code with caution, since it will reset ALL features that may have been programmed since the scanner's installation.**



**NOTE**

**DO NOT scan the Enter/Exit Programming Mode bar code before and after scanning this bar code.**

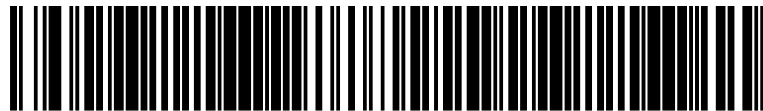

Standard Product Default Settings

---

## Datalogic Scanalyzer

The Datalogic website offers free download of the Datalogic Scanalyzer Configuration and Maintenance Tool. This program may be used instead of or in addition to the programming labels in this manual.

**NOTE**

**The Scanner must be placed into Service Port Mode before connecting to Scanalyzer. See "Service Port Mode" on page 14.**

The Datalogic Scanalyzer Configuration and Maintenance Tool ('Scanalyzer tool') is a Microsoft Windows®-based utility for current Datalogic Fixed Retail Products. The Scanalyzer tool has the ability to manage your Datalogic Fixed Retail Scanner, offering the following capabilities:

- Create and print your own programming barcode labels for scanning.
- Create, save, modify, upload, and download configuration files.
- Examine scanner configuration and compare to other files or default values.
- Read and modify individual configuration items on the scanner via a command interface.
- Read and save scanner information such as firmware version, model number and interface.
- Update scanner firmware.
- Read, save and send scanner event logs and statistics.

It is recommended that you have some familiarity with the product as well as a fundamental knowledge of the various operating modes prior to making any changes.

## Service Port Mode

To program the Magellan 1500i using software utilities such as Scanalyzer or Aladdin, the unit must first be placed into Service Port mode. There are two methods that can be used to accomplish this. Hold the Scan Button

1. Unplug the unit if needed.
2. While holding down the Scan Button on the top of the unit, plug the scanner in.
3. Quickly release the button as soon as the light on the button illuminates. The scanner will enter Service Port Mode.

**- OR -**

### Scan the Service Port Mode Barcode

Scan the following barcode to place the scanner in Service Port Mode:







# General Scanner Features

## **SCANNING FEATURES** starting on page 16

- 1D Double Read Timeout on page 16
- 2D Double Read Timeout on page 17
- Double Read Table Size on page 18
- Digital Watermark (Digimarc) Features on page 19
  - Digital Watermark (Digimarc) Enable on page 19
  - Digital Watermark (Digimarc) Double Read Timeout on page 20
  - Digital Watermark (Digimarc) Data Format on page 21
- 1D Inverse Read Control on page 22
- 2D Inverse Read Control on page 23
- Handheld State on page 24
- Center Zone Enable on page 25
- Center Zone Size on page 26
- Sleep Mode Timer on page 27
- Accelerometer Detect Threshold on page 28
- Accelerometer Reject Threshold on page 29
- Accelerometer Delay To Stationary on page 30
- Accelerometer Inmotion Threshold on page 31

## **LED AND BEEPER INDICATORS** starting on page 32

- Power On Alert on page 32
- External Read Indicator (ERI) on page 33
- ERI Timeout on page 34
- Good Read LED Idle State on page 35
- Scanner Control Button Options on page 36
- Good Read Beep Control on page 37
- Good Read Beep Frequency on page 38
- Good Read Beep Length on page 39
- Good Read Beep Volume on page 40
- Good Read When to Indicate on page 41
- Illumination During Disable Mode on page 42
- Object Sense Control on page 43
- Reading Illumination Duration on page 44
- Illumination Blank on Beep on page 45
- Green Spot Duration Time on page 46



## SCANNING FEATURES

### 1D Double Read Timeout

The 1D Double Read Timeout feature specifies the minimum allowable time which must pass before reading the same 1D label again (e.g. two identical items in succession).

To set the Double Read Timeout:

1. Scan the Enter/Exit Programming Mode barcode at the top of the page.
2. Scan your selection from the barcodes below. You'll need to cover any unused barcodes on this and the facing page to ensure that the scanner reads only the barcode you intend to scan.
3. Complete the programming sequence by scanning the Enter/Exit Programming Mode barcode.



**NOTE**

**If the incidence of multiple reads is not acceptable, increase the Double Read Timeout setting to a higher value.**



1D Double Read Timeout = 300ms



1D Double Read Timeout = 400ms



1D Double Read Timeout = 600ms



1D Double Read Timeout = 800ms

## 2D Double Read Timeout

The 2D Double Read Timeout feature specifies the minimum allowable time which must pass before reading the same 2D label again (e.g. two identical items in succession).

To set this feature:

1. Scan the Enter/Exit Programming Mode barcode at the top of the page at the top of the page.
2. Scan your selection from the barcodes below. You'll need to cover any unused barcodes on this and the facing page to ensure that the scanner reads only the barcode you intend to scan.
3. Complete the programming sequence by scanning the Enter/Exit Programming Mode barcode.



### NOTE

If the incidence of multiple reads is not acceptable, increase the Timeout setting to a higher value.



2D Double Read Timeout = 300ms



2D Double Read Timeout = 400ms



2D Double Read Timeout = 600ms



2D Double Read Timeout = 700ms



2D Double Read Timeout = 800ms



## Double Read Table Size

Specifies the number of labels to be tracked if double read protection is needed. Contact Technical Support for more information.

To set this feature:

1. Scan the Enter/Exit Programming Mode barcode at the top of the page.
2. Scan the barcode [Set Double Read Table Size](#) below. You'll need to cover any unused barcodes on this and the facing page to ensure that the scanner reads only the barcode you intend to scan.
3. Scan the appropriate digits from the [Alpha-Numeric Keypad in Appendix C](#) that represent the desired number of entries, using hex values. The selectable range is 01–25. Pad all numbers with leading zeros to yield a two-digit entry.
4. Scan the Enter/Exit Programming Mode barcode at the top of the page to exit Programming Mode.

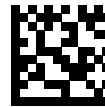

Set Double Read Table Size

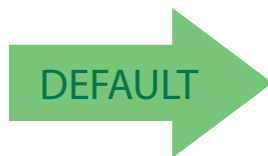

Default setting for this feature is: 7 Entries

## Digital Watermark (Digimarc) Features

### Digital Watermark (Digimarc) Enable

Enables/Disables the ability of the scanner to decode Digital Watermarks.  
To set this feature:

1. Scan the Enter/Exit Programming Mode barcode at the top of the page.
2. Scan your selection from the barcodes below. You'll need to cover any unused barcodes on this and the facing page to ensure that the scanner reads only the barcode you intend to scan.
3. Complete the programming sequence by scanning the Enter/Exit Programming Mode barcode.



**NOTE**

**The Digital Watermark feature must be enabled for decode functionality.**



Digital Watermark (Digimarc) = Disable



Digital Watermark (Digimarc) = Enable





## Digital Watermark (Digimarc) Double Read Timeout

Specifies the minimum allowable time which must pass before reading the same Digital Watermark (Digimarc) label again (e.g. two identical items in succession).

To set this feature:

1. Scan the Enter/Exit Programming Mode barcode at the top of the page.
2. Scan your selection from the barcodes below. You'll need to cover any unused barcodes on this and the facing page to ensure that the scanner reads only the barcode you intend to scan.
3. Complete the programming sequence by scanning the Enter/Exit Programming Mode barcode.



**NOTE**

**If the incidence of multiple reads is not acceptable, increase the Double Read Timeout setting to a higher value.**



Digimarc Double Read Timeout = 0.3 Seconds



Digimarc Double Read Timeout = 0.4 Seconds

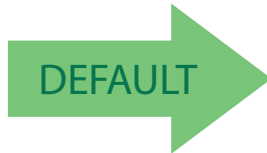

Digimarc Double Read Timeout = 0.5 Seconds



Digimarc Double Read Timeout = 0.7 Seconds



Digimarc Double Read Timeout = 1 Second

## Digital Watermark (Digimarc) Data Format

Selects the format for the watermark data. Choices are:

- Compatibility mode
- Databar-14
- Native

1. Scan the Enter/Exit Programming Mode barcode at the top of the page.
2. Scan your selection from the barcodes below. You'll need to cover any unused barcodes on this and the facing page to ensure that the scanner reads only the barcode you intend to scan.
3. Complete the programming sequence by scanning the Enter/Exit Programming Mode barcode.



**NOTE**

**The Digital Watermark feature must be enabled for decode functionality.**

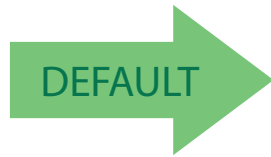

Digital Watermark (Digimarc) Data Format = Compatibility mode



Digital Watermark (Digimarc) Data Format = Databar-14 mode



Digital Watermark (Digimarc) Data Format = Native mode



## 1D Inverse Read Control

This configuration item is used to toggle inverted label reading for 1D barcodes, for example, a label printed as white on black as opposed to black on white.

To set this feature:

1. Scan the Enter/Exit Programming Mode barcode at the top of the page.
2. Scan your selection from the barcodes below. You'll need to cover any unused barcodes on this and the facing page to ensure that the scanner reads only the barcode you intend to scan.
3. Complete the programming sequence by scanning the Enter/Exit Programming Mode barcode.

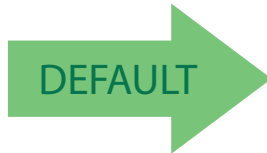

1D Inverse Read Control = Enable



1D Inverse Read Control = Disable



## 2D Inverse Read Control

This configuration item is used to toggle inverted label reading for 2D barcodes, for example, a label printed as white on black as opposed to black on white.

To set this feature:

1. Scan the Enter/Exit Programming Mode barcode at the top of the page.
2. Scan your selection from the barcodes below. You'll need to cover any unused barcodes on this and the facing page to ensure that the scanner reads only the barcode you intend to scan.
3. Complete the programming sequence by scanning the Enter/Exit Programming Mode barcode.

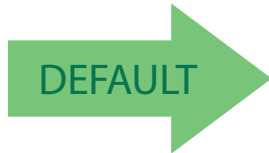

2D Inverse Read Control = Enable



2D Inverse Read Control = Disable



## Handheld State

When enabled, places the scanner in Handheld State of operation.

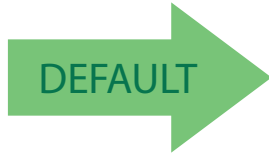

Handheld State = Disable



Handheld State = Enable

## Center Zone Enable

Enables or Disables Center Zone Label Proofing. In "Always On" mode, Zone Proofing will be applied to labels presented to the scanner while in Active State and in HandHeld State.



### NOTE

Labels rendered by segment assembly carry no coordinate data, and will not be proofed if Center Zone Label Proofing is enabled.

1. Scan the Enter/Exit Programming Mode barcode at the top of the page.
2. Scan your selection from the barcodes below. You'll need to cover any unused barcodes on this and the facing page to ensure that the scanner reads only the barcode you intend to scan.
3. Complete the programming sequence by scanning the Enter/Exit Programming Mode barcode.

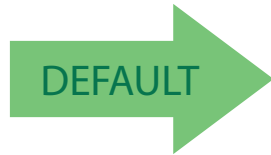

Center Zone Proofing = Disable



Center Zone Proofing = On only when in ScannerActiveMode/  
HandheldState



Center Zone Proofing = Always on



## Center Zone Size

Specifies the Center Zone size as a percentage of the full image.

1. Scan the Enter/Exit Programming Mode barcode at the top of the page.
2. Scan the barcode [Set Center Zone Size](#) below. You'll need to cover any unused barcodes on this and the facing page to ensure that the scanner reads only the barcode you intend to scan.
3. Scan the appropriate digits from the [Alpha-Numeric Keypad in Appendix C](#) that represent the desired percentage in hex. The selectable range is 01 – 100%. Pad all numbers with leading zeros to yield a two-digit entry (01 – 100).
4. Complete the programming sequence by scanning the Enter/Exit Programming Mode barcode.

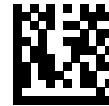

Set Center Zone Size

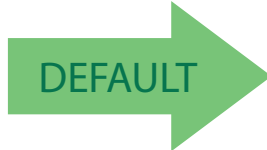

Default setting for this feature is: 10 percent

## Sleep Mode Timer

This feature specifies the amount of time of inactivity (with no label reads) before the scanner enters sleep mode.

To set this feature:

1. Scan the Enter/Exit Programming Mode barcode at the top of the page.
2. Scan the barcode [Set Sleep Mode Timer](#) below. You'll need to cover any unused barcodes on this and the facing page to ensure that the scanner reads only the barcode you intend to scan.
3. Scan the appropriate digits from the [Alpha-Numeric Keypad in Appendix C](#) to represent the desired time interval. The selectable range is 000–255 in 15 second increments. Pad all numbers with leading zeros to yield a three-digit entry (000–255).
4. Scan the Enter/Exit Programming Mode barcode at the top of the page to exit Programming Mode.



Set Sleep Mode Timer

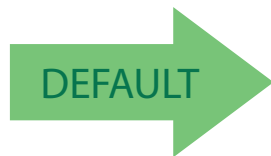

Default setting for this feature is: 5 minutes



## Accelerometer Detect Threshold

Sets acceleration threshold that must be exceeded for an InMotionEvent to be generated.



NOTE

Setting the Reject Threshold (page 29) to **LOWEST** while this feature is set to **HIGHEST** will result in the scanner rejecting all motion inputs.



Accelerometer Detect Threshold = Lowest



Accelerometer Detect Threshold = Low



Accelerometer Detect Threshold = Medium



Accelerometer Detect Threshold = High



Accelerometer Detect Threshold = Highest

## Accelerometer Reject Threshold

Sets acceleration threshold above which data from the accelerometer will be rejected.



**NOTE**

Setting this feature to **LOWEST** while the **Detect Threshold** (page 28) is set to **HIGHEST** will result in the scanner rejecting all motion inputs.



Accelerometer Reject Threshold = Lowest

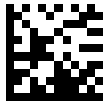

Accelerometer Reject Threshold = Low

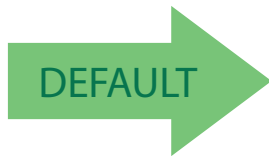

Accelerometer Reject Threshold = Medium



Accelerometer Reject Threshold = High



Accelerometer Reject Threshold = Highest



## Accelerometer Delay To Stationary

Sets amount of time the scanner will remain in Scanner Active Mode/Handheld State following the last valid detected motion.

1. Scan the Enter/Exit Programming Mode barcode at the top of the page.
2. Scan the barcode [Accelerometer Delay To Stationary](#) below. You'll need to cover any unused barcodes on this and the facing page to ensure that the scanner reads only the barcode you intend to scan.
3. Scan the appropriate digits from the [Alpha-Numeric Keypad in Appendix C](#) that represent the desired time interval. The selectable range is 00–255, in 10 millisecond increments.
4. Scan the Enter/Exit Programming Mode barcode at the top of the page to exit Programming Mode.



Accelerometer Delay To Stationary

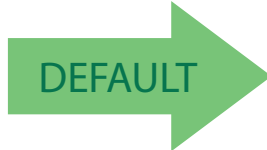

Default setting for this feature is: 150 mS



## Accelerometer Inmotion Threshold

Sets acceleration threshold that must be exceeded once in ScannerActiveMode/HandheldState for the device to remain in ScannerActiveMode/HandheldState.

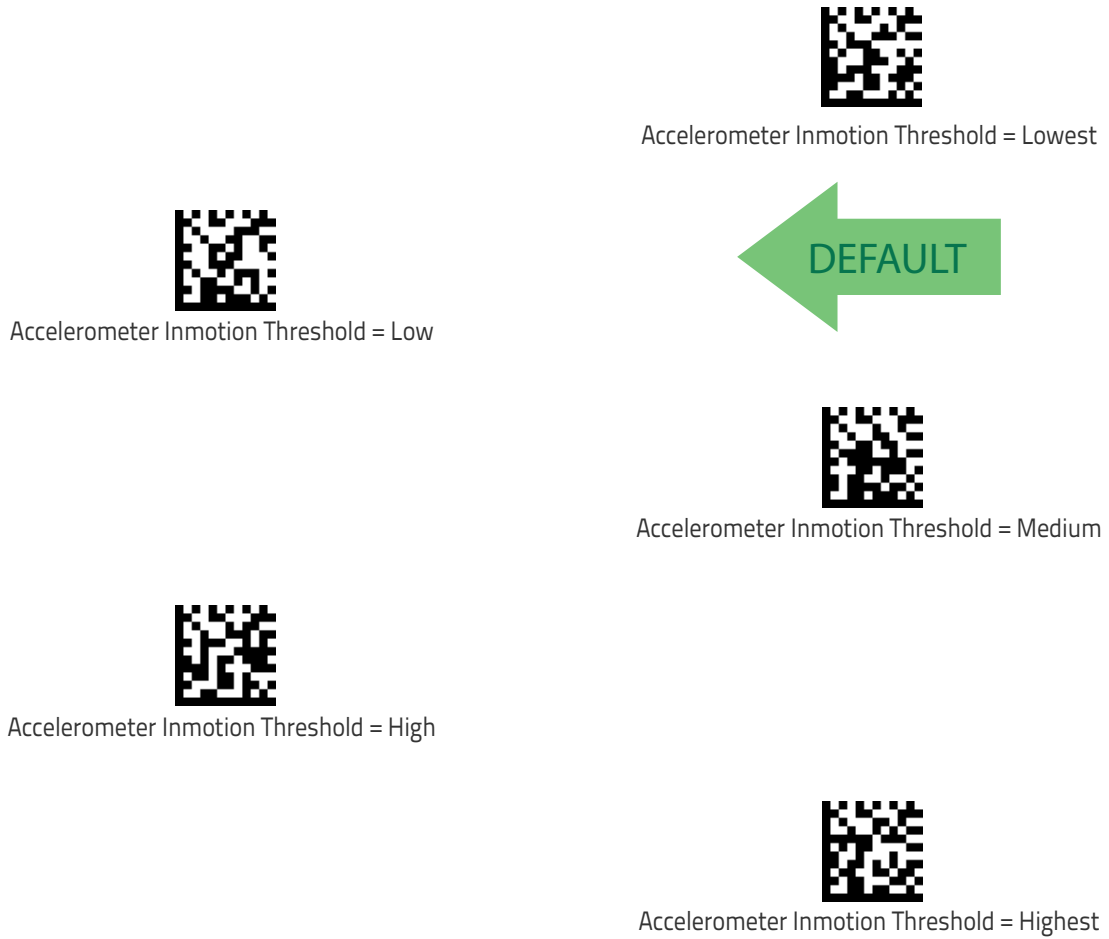



## LED AND BEEPER INDICATORS

### Power On Alert

Disables or enables the indication that the scanner has finished all its power up tests and is now ready for operation (usually a single beep).



NOTE

This feature is configurable so the beep can be replaced with a .wav file.



Power-up Tone Control = No Tone



Power-up Tone Control = Play Tone



## External Read Indicator (ERI)



NOTE

This feature is available only through use of a special cable.

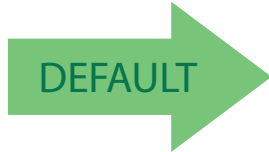

ERI Active State = Active Low



ERI Active State = Active High



## ERI Timeout

Specifies the amount of time the External Read Indicator (ERI) signal is held active for a good read. Sets the ERI timeout duration using hex values from 000 to 255 in increments of ten milliseconds (10ms or 0.01 seconds).

To configure this feature:

1. Scan the “Enter/Exit Programming Mode” barcode above to place the unit in Programming Mode.
2. Scan “Set ERI Timeout,” followed by the two digits (zero padded) from the [Alpha-Numeric Keypad in Appendix C](#) representing the desired time value.
3. Exit programming mode by scanning the “Enter/Exit Programming Mode” barcode again.



Set ERI Timeout

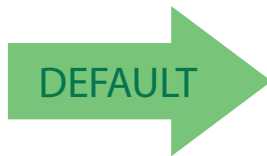

Default setting for this feature is:  
002 -20mS

## Good Read LED Idle State

This feature specifies the state of the green scanner LEDs when the scanner is idle and ready to read a label. Options are:

- Off
- On dim

To set the Scanner LEDs Idle State:

1. Scan the Enter/Exit Programming Mode barcode at the top of the page.
2. Scan your selection from the barcodes below. You'll need to cover any unused barcodes on this and the facing page to ensure that the scanner reads only the barcode you intend to scan.
3. Complete the programming sequence by scanning the Enter/Exit Programming Mode barcode.



Scanner LED Idle State = Off



Scanner LED Idle State = On Dim





## Scanner Control Button Options

Configure the Scanner Control Button to one of the following modes of operation:

- Enable all functions: Volume, tone, diagnostics and reset.
- Enable only volume, tone and reset.
- Enable reset only.
- Disable all button functions

To set the desired Scanner Control Button Option:

1. Scan the Enter/Exit Programming Mode barcode at the top of the page.
2. Scan your selection from the barcodes below. You'll need to cover any unused barcodes on this and the facing page to ensure that the scanner reads only the barcode you intend to scan.
3. Complete the programming sequence by scanning the Enter/Exit Programming Mode barcode.



Scanner Control Button = Enable All Functions



Scanner Control Button = Enable Only Volume Tone and Reset



Scanner Control Button = Enable Reset Only



Scanner Control Button = Disable All Functions

## Good Read Beep Control

This feature enables/disables scanner beep upon successfully decoding of a label.

To set this feature:

1. Scan the Enter/Exit Programming Mode barcode at the top of the page.
2. Scan your selection from the barcodes below. You'll need to cover any unused barcodes on this and the facing page to ensure that the scanner reads only the barcode you intend to scan.
3. Complete the programming sequence by scanning the Enter/Exit Programming Mode barcode.



Good Read Beep Control = Disable



Good Read Beep Control = Enable





## Good Read Beep Frequency

Adjusts the scanner's good read beep to sound at low, medium, or high frequency (controls the beeper's pitch/tone).

- Low
- Medium
- High

To set this feature:

1. Scan the Enter/Exit Programming Mode barcode at the top of the page.
2. Scan your selection from the barcodes below. You'll need to cover any unused barcodes on this and the facing page to ensure that the scanner reads only the barcode you intend to scan.
3. Complete the programming sequence by scanning the Enter/Exit Programming Mode barcode.



Good Read Beep Frequency = Low



Good Read Beep Frequency = Medium



Good Read Beep Frequency = High



## Good Read Beep Length

Specifies the duration of a good read beep.

To set this feature:

1. Scan the Enter/Exit Programming Mode barcode at the top of the page.
2. Scan the barcode, [Set Good Read Beep Length on page 39](#). You'll need to cover any unused barcodes on this and the facing page to ensure that the scanner reads only the barcode you intend to scan.
3. Scan the appropriate digits from the [Alpha-Numeric Keypad in Appendix C](#) that represent the desired good read beep length setting. The selectable range is 1–255, which is the timeout in 10–millisecond increments. Times have a tolerance of  $\pm 25\%$ . Pad all single and double digit numbers with leading zeroes to yield a three–digit entry (001–255).

Examples:

001 = 10ms

005 = 50ms

040 = 400ms

4. The scanner will automatically exit Programming Mode when the appropriate amount of digits have been scanned.



Set Good Read Beep Length

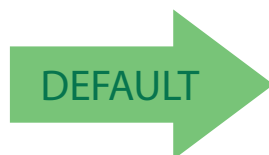

Default setting for this feature is:  
008 - 80ms



## Good Read Beep Volume

Selects the beeper volume upon a good read beep. There are five selectable volumes, with each volume increment adding approximately five decibels to the previous level:

- Low
- Medium Low
- Medium
- Medium High
- High

To set this feature:

1. Scan the Enter/Exit Programming Mode barcode at the top of the page.
2. Scan your selection from the barcodes below. You'll need to cover any unused barcodes on this and the facing page to ensure that the scanner reads only the barcode you intend to scan.
3. Complete the programming sequence by scanning the Enter/Exit Programming Mode barcode.



Good Read Beep Volume = Low

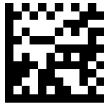

Good Read Beep Volume = Medium Low

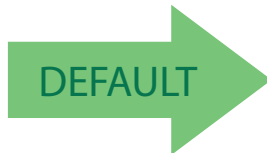

Good Read Beep Volume = Medium



Good Read Beep Volume = Medium High



Good Read Beep Volume = High

## Good Read When to Indicate

This feature specifies when the scanner will provide indication (beep and/or flash its green LEDs) upon successfully reading a barcode.

- Good Read = Indicate after decode.
- Good Read = Indicate after transmit.
- Good Read = Indicate after CTS goes inactive, then active.  
This mode applies to RS-232 STD and RS-232 WN interfaces only. If set in other interfaces, “Indicate after decode” mode will be implemented.
- Good Read = Indicate after each output structure proofed.  
When beeping after each output structure decoded, if there are multiple output structures, there is a delay after the beep has finished. This delay is equal to the [Good Read Beep Length](#) on page 39.

To set the Good Read When to Indicate feature:

1. Scan the Enter/Exit Programming Mode barcode at the top of the page.
2. Scan the desired mode barcode from those provided below You’ll need to cover any unused barcodes on facing pages to ensure that the scanner reads only the barcode you intend to scan.
3. Complete the programming sequence by scanning the Enter/Exit Programming Mode barcode.

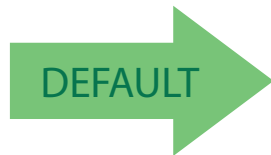

Good Read When to Indicate = After Decode



Good Read When to Indicate = After Transmit



Good Read When to Indicate = After CTS goes Inactive,  
Then Active



Good Read When to Indicate = After Each Output  
Structure Proofed



## Illumination During Disable Mode

This feature allows illumination to be turned off when the scanner is in “disable” mode. It determines if the imager illumination is controlled by host interface enable/disable commands.

**Disable** = Illumination is not controlled by host enable/disable commands, illumination stays on when disabled.

**Enable** = Illumination is controlled by host enable/disable commands, illumination is on when enabled and off when disabled.

To set this feature:

1. Scan the Enter/Exit Programming Mode barcode at the top of the page.
2. Scan your selection from the barcodes below.
3. Complete the programming sequence by scanning the Enter/Exit Programming Mode barcode.



Illumination During Disable Mode = Disable



Illumination During Disable Mode = Enable



## Object Sense Control

This feature controls the illumination idle. It determines whether the main illumination is controlled by the Object Sensing system, or alternatively, stays continuously on.

**Enable** = Illumination is controlled by using Object Sense

**Disable** = Normal illumination is used but it goes off during sleep mode / disable mode

To set this feature:

1. Scan the Enter/Exit Programming Mode barcode at the top of the page.
2. Scan your selection from the barcodes below. You'll need to cover any unused barcodes on this and the facing page to ensure that the scanner reads only the barcode you intend to scan.
3. Complete the programming sequence by scanning the Enter/Exit Programming Mode barcode.

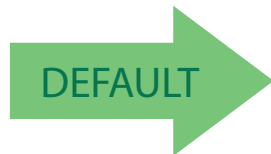

Object Sense Control = Enable



Object Sense Control =Disable



## Reading Illumination Duration

This feature specifies how long the illumination stays on after a label or label segment is read.

To set this feature:

1. Scan the Enter/Exit Programming Mode barcode at the top of the page.
2. Scan your selection from the barcodes below. You'll need to cover any unused barcodes on this and the facing page to ensure that the scanner reads only the barcode you intend to scan.
3. Complete the programming sequence by scanning the Enter/Exit Programming Mode barcode.



Reading Illumination Duration = 1 Seconds



Reading Illumination Duration = 3 Seconds

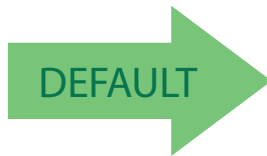

Reading Illumination Duration = 5 Seconds

## Illumination Blank on Beep

Enable this feature to turn off illumination while sound is playing.

To set this feature:

1. Scan the Enter/Exit Programming Mode barcode at the top of the page.
2. Scan your selection from the barcodes below.
3. Complete the programming sequence by scanning the Enter/Exit Programming Mode barcode.

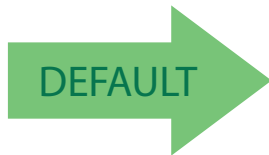

Illumination Blank on Beep = Disable



Illumination Blank on Beep = Enable



## Green Spot Duration Time

This feature specifies the time that the Green Spot is active.

To set this feature:

1. Scan the Enter/Exit Programming Mode barcode at the top of the page.
2. Scan your selection from the barcodes below.
3. Complete the programming sequence by scanning the Enter/Exit Programming Mode barcode.



Green Spot Duration = Disabled



Green Spot Duration = 50 mS



Green Spot Duration = 100 mS



Green Spot Duration = 1 second



Green Spot Duration = 2.5 sec (250mS)





# Imaging Features

## **IMAGING FEATURES** starting on page 48

- Image Capture to the Host by Host Command on page 48
- Image Destination on page 49
- Picture Retrieval Timeout on page 50
- Image Capture Delay on page 52
- Image Format on page 53
- Image Size on page 54
- Image Brightness on page 55
- Image Contrast on page 57
- Image Compression on page 59
- Region of Interest (ROI) on page 60
- Number of Imager Frames on page 62

## **CELL PHONE SETTINGS** starting on page 63

- Cell Phone Mode on page 63
- Cell Mode Percent on page 64

## Imaging Features

### Image Capture to the Host by Host Command

This feature is only available for RS-232 and USB COM interfaces.



#### NOTE

If the USB COM interface has been selected, follow the instructions in USB Interface Selection on page 67.

The host command format is as follows:

P<cnt>pSBC

where:

**P** – ASCII 'P' used as preamble of pass-through commands

**<cnt>** – binary value of 4 indicating 4 bytes to follow

**p** – ASCII lowercase 'p' ; command to take a picture

**S** – size value of image as ASCII character

'S' == uses scanner's configuration value

'0'–VGA, (640X480)

'1'–WVGA, (752X480)

'2'–SXGA, (1280x1027)

'3'–CIF (320x240)

**B** – brightness value in ASCII

'B' == uses scanner's configuration value CI\_IMAGE\_BRIGHTNESS

else '0' thru'9' specifies brightness

**C** – contrast value in ASCII

'C' == uses scanner configuration value CI\_IMAGE\_CONTRAST

else '0' thru'9' specifies contrast

IF the image is of a type the scanner supports, capture and transmission occurs, and the command is of proper format

THEN

The scanner will transmit an ACK (0x06) to the Host in response to this command.

The image data transmission starts with a 4 byte binary field representing (Big Endian) number of bytes to follow.

If the “number of bytes to follow” value is zero, there was a problem with generating the image and the request should be retried.

ELSE

The scanner will transmit a BEL (0x07) to the Host in response to this command.

ENDIF

## Image Destination

Specifies the destination for pictures/images taken with a camera button press.

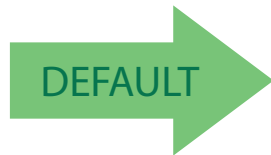

Image Destination = Disable

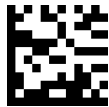

Image Destination = Host port



## Picture Retrieval Timeout

This feature sets the amount of time after the picture retrieval label is sent to the POS that the scanner will allow subsequent picture taking requests via button press.



NOTE

If set to 0, the picture retrieval timeout will not be used and a picture will remain accessible until another is taken or the scanner is reset.

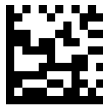

Picture Retrieval Timeout = 0



Picture Retrieval Timeout = 1 second



Picture Retrieval Timeout = 2 seconds



Picture Retrieval Timeout = 3 seconds



Picture Retrieval Timeout = 4 seconds

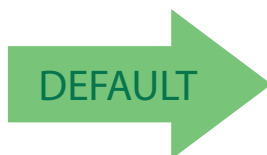

Picture Retrieval Timeout = 5 seconds

### Picture Retrieval Timeout (continued)



Picture Retrieval Timeout = 6 seconds



Picture Retrieval Timeout = 7 seconds



Picture Retrieval Timeout = 8 seconds



Picture Retrieval Timeout = 9 seconds



Picture Retrieval Timeout = 10 seconds



## Image Capture Delay

This feature specifies the amount of time after the image capture is initiated by a button press until the picture is taken.

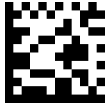

Image Capture Delay = 0 seconds



Image Capture Delay = 1 second



Image Capture Delay = 2 seconds

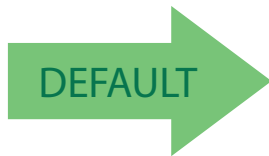

Image Capture Delay = 5 seconds



Image Capture Delay = 10 seconds

## Image Format

This feature specifies the output format for images taken using the camera function of the scanner.

Choices are:

- JPG
- BMP

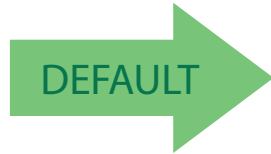

Image Format = JPG



Image Format = BMP



## Image Size

This feature specifies the size of the captured image. Choices are:

**VGA** — Video Graphics Array. 640 x 480 pixels.

**WVGA** — Wide Video Graphics Array, various physical sizes, 16:9 shape

**Full Size** — Maximum image height and width. Largest image.

**Half VGA** — Half of the size of a regular VGA image, 320 x 240 pixels. Smallest image.

**Scaled VGA** — Video Graphics Array, 640 x 480 pixels.

**ROI** — The size of an ROI image is determined by the value of the ROI setting. See "Region of Interest (ROI)" on page 60.

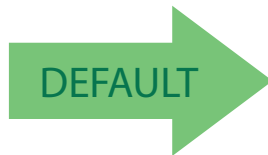

Image Size = VGA



Image Size = WVGA



Image Size = Full Size



Image Size = Half VGA



Image Size = Scaled VGA



Image Size = ROI



## Image Brightness

Specifies the image brightness value. The selectable range is from 0 to 10, with 10 being the brightest.



Image Brightness = 0



Image Brightness = 1



Image Brightness = 2



Image Brightness = 3



Image Brightness = 4



Image Brightness = 5



Image Brightness = 6



Image Brightness = 7



### Image Brightness (continued)



Image Brightness = 8



Image Brightness = 9



Image Brightness = 10

## Image Contrast

This feature sets the contrast level for a captured image. The selectable range is from 0 to 10, with 0 being the lowest and 10 being the highest contrast.



Image Contrast = 0



Image Contrast = 1



Image Contrast = 2

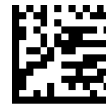

Image Contrast = 3



Image Contrast = 4



Image Contrast = 5



Image Contrast = 6



Image Contrast = 7



### Image Contrast (continued)



Image Contrast = 8



Image Contrast = 9



Image Contrast = 10

## Image Compression

Specifies the starting image compression factor.



Image Compression = 5



Image Compression = 10



Image Compression = 25



Image Compression = 50



Image Compression = 70



Image Compression = 80



Image Compression = 90

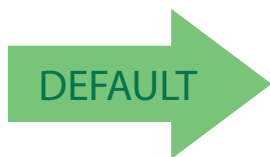
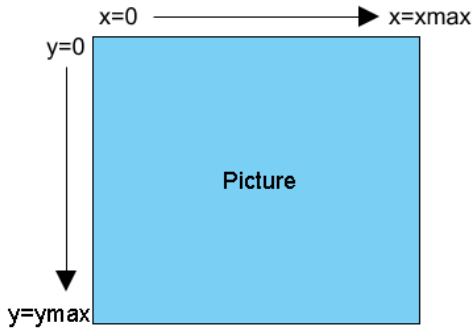

Image Compression = 100



## Region of Interest (ROI)

This feature specifies the X-Y coordinates for the Region of Interest (ROI). The region of interest coordinates are defined as follows:



Where **xmax** is the x-size of a full size image (1279 pixels), and **ymin** is the y-size of a full size image (1023 pixels).

For example, a coordinate set of 0, 639, 512, 1023 will produce the bottom left section of a full size image.



**Picture coordinates are NOT defined on a Cartesian coordinate plane.**

**NOTE**

- Byte [0]-[1]: 16 bit hex value xmin
- Byte [2]-[3]: 16 bit hex value xmax
- Byte [4]-[5]: 16 bit hex value ymin
- Byte [6]-[7]: 16 bit hex value ymax



**If the xmax/ymax values are configured larger than the maximum values above, they will default to 1 less than their respective maximum values.**

**NOTE**

**If the xmin/ymin values are configured larger than xmax/ymax, they will default to 0.**

**Images extracted with ROI must be in JPG format.**

### Region of Interest (continued)

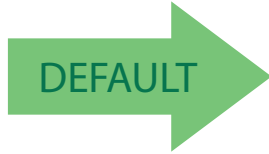

Region of Interest = default



Region of Interest = upper left quadrant



Region of Interest = upper right quadrant



Region of Interest = lower left quadrant



Region of Interest = lower right quadrant



## Number of Imager Frames

This feature specifies the number of consecutive frames captured while using imager register values to toggle between Near Field and Far Field performance. This can be used when a greater depth of field is needed.

- Byte0 = num frames using Set A  
Byte1 = num frames using Set B
- Byte0 = zero  
Byte1 = zero: Toggling is disabled. Reg values for current mode used.
- Byte0 = zero  
Byte1 = nonzero: Reg values for toggle Set B always used.
- Byte0 = nonzero  
Byte1 = zero: Reg values for toggle Set A always used.
- Byte0 = nonzero  
Byte1 = nonzero: Reg values toggle between Set A and Set B.

To set this feature:

1. Scan the Enter/Exit Programming Mode barcode at the top of the page.
2. Scan the barcode [Set Number of Frames](#) below. You'll need to cover any unused barcodes on this and the facing page to ensure that the scanner reads only the barcode you intend to scan.
3. Scan the appropriate digits from the [Alpha-Numeric Keypad in Appendix C](#).
4. Scan the Enter/Exit Programming Mode barcode at the top of the page to exit Programming Mode.



Set Number of Frames

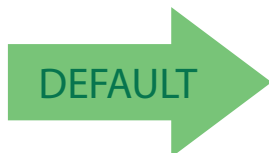

Default setting for this feature is: 0 (Near Field)



## Cell Phone Settings

### Cell Phone Mode

Enables/disables the operating mode for mobile phone read.

- In Toggle mode each host command toggles the mode.
- In Timer Expiration mode, a single host command enters Cell Phone mode but it is exited at timer expiration. The timer is not restarted on a label read.
- In Always On mode, the scanner stays on regardless of host command or button push. It will not enter sleep mode.





## Cell Mode Percent

Specifies the rate of frames dedicated to reading cell phones. Cell reading feature must be enabled for this to be active. The setting reflects a variable setting (or percentage) of frames dedicated to cell reading



**NOTE**

**As the percentage is increased, object sense (if enabled) will become less responsive. Anything above 10% will have a negative impact on scanning performance.**

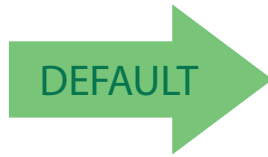

Cell Mode Percent = 2.5% (Very Low)



Cell Mode Percent = 5% (Low)



Cell Mode Percent = 10% (Medium)



Cell Mode Percent = 20% (Medium High)



Cell Mode Percent = 50% (High)



# Interface Related Features

## **INTERFACE SELECTION** starting on page 66

USB Interface Selection on page 67

RS-232 Interface Selection on page 68

Maximum Host-Transmitted Message Length on page 69

## **USB INTERFACE FEATURES** starting on page 71

- USB-COM Interface Setup on page 71

- USB Power Compliance on page 71

## **USB KEYBOARD FEATURES** starting on page 72

- Keyboard Layout on page 72

- USB Keyboard Country Mode on page 72

- USB Keyboard Caps Lock State on page 75

- USB Keyboard Send Control Characters on page 76

- USB Keyboard Intercharacter Delay on page 77

- USB Keyboard Additional Interface Options on page 78

USB OEM Scanner Device Type on page 79

- USB OEM Scanner Device Type on page 79

## **RS-232 INTERFACE FEATURES** starting on page 81

- RS-232 Baud Rate on page 81

- RS-232 Number of Data Bits on page 83

- RS-232 Number of Stop Bits on page 83

- RS-232 Parity on page 84

- RS-232 Hardware Control on page 85

- RS-232 Intercharacter Delay on page 86

- RS-232 Software Flow Control on page 87

- RS-232 Beep on ASCII BEL on page 88

- Beep on Not on File on page 88

- RS-232 ACK NAK Features on page 89

- ACK NAK Enable on page 89

- RS-232 ACK Character on page 90

- RS-232 NAK Character on page 91

- RS-232 Retry on ACK NAK Timeout on page 92

- RS-232 ACK NAK Timeout Value on page 93

- RS-232 ACK NAK Retry Count on page 94

- RS-232 ACK NAK Error Handling on page 95

- RS-232 Indicate Transmission Failure on page 96

## INTERFACE SELECTION

### Interface Type

Specifies the current scanner interface.



**NOTE**

The correct interface cable is generally included for the reader interface type you ordered.



**NOTE**

If the scanner's interface type must be changed, always be sure that interface configuration is the **FIRST** item scanned during a programming session. (Selecting an interface type resets **ALL** other configuration items to the factory default for that interface type.)



**CAUTION**

Great care should be taken to select the correct interface type, since you can cause damage to the scanner and/or POS terminal by attempting to change to an incompatible interface. **ALWAYS** make interface selections with the host cable **DISCONNECTED**.



**NOTE**

When an interface is selected, the scanner loads the configuration for that interface as the selection is made. Any custom configurations done in the previous interface will not be carried over to the configuration for the new interface.

## USB Interface Selection

Remember to cover any unused barcodes on this and the facing page to ensure that the scanner reads only the barcode you intend to scan.



**CAUTION**

**Great care should be taken to select the correct interface type, since you can cause damage to the scanner and/or POS terminal by attempting to change to an incompatible interface. ALWAYS make interface selections with the host cable DISCONNECTED.**



Interface Type = USB OEM



Interface Type = USB TEC



Interface Type = USB COM



Interface Type = USB Keyboard



## RS-232 Interface Selection

This section lists the factory default settings for each of the menu commands for the standard RS-232 interface, indicated by a green arrow. Exceptions to default settings for other interfaces, including Wincor-Nixdorf, can be found in Appendix D, Factory Default Settings.



**CAUTION**

**Great care should be taken to select the correct interface type, since you can cause damage to the scanner and/or POS terminal by attempting to change to an incompatible interface. ALWAYS make interface selections with the host cable DISCONNECTED.**



Interface Type = RS-232 Standard



Interface Type = RS-232 Wincor-Nixdorf

## INTERFACE FEATURES

### Maximum Host-Transmitted Message Length

Specifies the maximum number of data characters allowed in messages transmitted to the host.

To set the Maximum Host-Transmitted Message Length:

1. Scan the Enter/Exit Programming Mode barcode at the top of the page.
2. Scan the barcode, [Set Maximum Host-Transmitted Message Length on page 69](#) below. You'll need to cover any unused barcodes on this and the facing page to ensure that the scanner reads only the barcode you intend to scan.
3. Scan the appropriate digits from the [Alpha-Numeric Keypad on page 296](#) that represent the desired maximum host-transmitted message length. The selectable range is 0-249 data characters. (Labels that are longer than this length are not read.) Pad all single and double digit numbers with leading zeroes to yield a three-digit entry (000-249).



**If this configuration item is set to 0 (000), there is no general length limit imposed on data being transmitted to the host.**

#### NOTE

4. The scanner will automatically exit Programming Mode when the appropriate amount of digits have been scanned.



Set Maximum Host-Transmitted Message Length

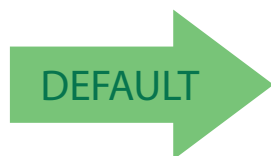

Default setting for this feature is:  
000 - No general limit imposed



## Ignore Host Commands

When set to ignore host commands, the scanner will ignore all host commands except the minimum set necessary to keep the interface active and transmit labels. For normal operation of the interface, select Obey Host Commands.

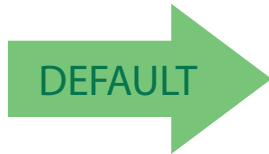

Ignore Host Commands = Don't Ignore



Ignore Host Commands = Ignore



## USB Interface Features

### USB-COM Interface Setup

The Datalogic USB-COM driver is required to use USB-COM or USB-COM DL interfaces. The Datalogic USB-COM driver can be downloaded from the Datalogic website.

Before plugging your scanner into the Host PC, please ensure you have already copied the executable DLS USB-COM driver file to your PC and that the scanner's interface is set to USB COM or USB COM DL.

1. Execute the DLS USB-COM driver file.
2. When the scanner is first plugged into the PC, Windows will bring up the "Found New Hardware" message.
3. The installation is complete.

### USB Power Compliance

This feature enables / disables the ability of the Universal Interface to hold off system controller power until after USB POS Host enumeration.

To set this feature:

1. Scan the Enter/Exit Programming Mode barcode at the top of the page.
2. Scan the desired option from the barcodes below. You'll need to cover any unused barcodes on this and the facing page to ensure that the scanner reads only the barcode you intend to scan.
3. Complete the programming sequence by scanning the Enter/Exit Programming Mode barcode.



USB Power Compliance = Disable



USB Power Compliance = Enable





## USB Keyboard Features

As a keyboard interface, the scanner supports most popular PC terminals.

### Keyboard Layout

The Keyboard Layout option supports many countries. For details about Keyboard Layout, please refer to your operating system manual.

### USB Keyboard Country Mode

This feature specifies the country/language that will be supported by the keyboard.

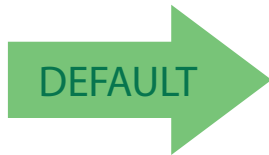

USB Keyboard Country Mode = USA



USB Keyboard Country Mode = Belgium



USB Keyboard Country Mode = Britain



USB Keyboard Country Mode = Denmark



USB Keyboard Country Mode = France



USB Keyboard Country Mode = Germany

## USB Keyboard Country Mode (continued)



USB Keyboard Country Mode = Italy



USB Keyboard Country Mode =  
Norway



USB Keyboard Country Mode =  
Portugal



USB Keyboard Country Mode = Spain



USB Keyboard Country Mode =  
Sweden



USB Keyboard Country Mode =  
Switzerland



USB Keyboard Country Mode =  
Japanese 106-key

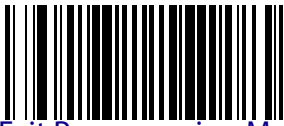

## USB Keyboard Country Mode (continued)



USB Keyboard Country Mode = Hungary



USB Keyboard Country Mode = Czech Republic



USB Keyboard Country Mode = Slovakia



USB Keyboard Country Mode = Romania



USB Keyboard Country Mode = Croatia



USB Keyboard Country Mode = Poland



USB Keyboard Country Mode = French Canadian



USB Keyboard Country Mode = Turkish

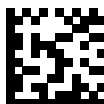

USB Keyboard Country Mode = Russian

## USB Keyboard Caps Lock State

This feature specifies the format in which the scanner sends character data. Selections are:

**Caps Lock OFF** — Send character data in normal format

**Caps Lock ON** — Send character data in reverse case

**Shift Lock Mode** — This setting results in a Caps Lock OFF functionality.

**Caps Lock Compensation Mode** — This only applies to USB Keyboard. For other interfaces, this setting results in a Caps Lock OFF functionality.

To set this feature:

1. Scan the Enter/Exit Programming Mode barcode at the top of the page.
2. Scan the desired selection from the barcodes below. You'll need to cover any unused barcodes on this and the facing page to ensure that the scanner reads only the barcode you intend to scan.
3. Complete the programming sequence by scanning the Enter/Exit Programming Mode barcode.

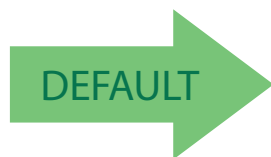

USB Keyboard Caps Lock State =  
Caps Lock OFF



USB Keyboard Caps Lock State =  
Caps Lock ON



USB Keyboard Caps Lock State =  
Shift Lock Mode



USB Keyboard Caps Lock State =  
Caps Lock Compensation



### USB Keyboard Send Control Characters

This feature specifies how the scanner transmits ASCII control characters to the host.



**NOTE**

Affects suffix and prefix characters. When disabled, only ASCII characters between 20H and 127H inclusive (space... delete) plus special characters 0DH (carriage return), 08H (backspace), 27H (ESC), 09H (right tab) and 0BH (left tab) are transmitted.

Choices are:

**Disable** — No control characters are sent to the host.

**Enable transmission of control characters to host** — Control characters are sent to the host.

**Send characters between 00H and 1FH** — Send characters between 00H and 1FH according to special function–key mapping table (This is used to send keys that are not in normal ASCII set; a unique set is provided for each available scancode set).

To set this feature:

1. Scan the Enter/Exit Programming Mode barcode at the top of the page.
2. Scan the barcode for the desired setting below. You'll need to cover any unused barcodes on this and the facing page to ensure that the scanner reads only the barcode you intend to scan.
3. Complete the programming sequence by scanning the Enter/Exit Programming Mode barcode.

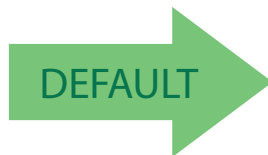

Keyboard Send Control Characters = Disable



Keyboard Send Control Characters = Enable transmission of control characters to host



USB Keyboard No Keyboard Support = Send characters between 00H and 1FH

## USB Keyboard Intercharacter Delay

Specifies a time delay between characters.

To set this feature:

1. Scan the Set USB Keyboard Intercharacter Delay barcode below.
2. Scan the appropriate characters/digits from the [Alpha-Numeric Keypad in Appendix C](#) that represent the desired delay. The selectable range for this option is any decimal value from 00 (no delay) to 99 in 10 ms increments. A table containing the ASCII Character Set and their corresponding decimal values is available in the inside back cover of this manual. ASCII parameters must be input by scanning decimal digits for each character. Pad all single digit numbers with leading zero to yield a two-digit entry (00–99). Thus, to set an intercharacter delay of 70ms, barcodes containing the digits '0' and '7' must be scanned.
3. Complete the programming sequence by scanning the Enter/Exit Programming Mode barcode.



Set USB Keyboard Intercharacter Delay



Default setting for this feature is: 01 (10ms)



## USB Keyboard Additional Interface Options

See [Appendix E, Keyboard Function Key Mappings](#) for more information.

To set this feature:

1. Scan the Enter/Exit Programming Mode bar code.
2. Scan your selection from the bar codes below. You'll need to cover any unused bar codes on this and the facing page to ensure that the scanner reads only the bar code you intend to scan.
3. Complete the programming sequence by scanning the Enter/Exit Programming Mode bar code.



USB Keyboard Interface Option 1 =  
Use Rev C function table



USB Keyboard Interfaces Option 2 =  
Use Rev D function table





## USB-OEM Features

### USB OEM Scanner Device Type

The OEM–USB protocol allows for the scanner to be identified as one of two different types of barcode scanners. Depending on what other scanners you may already have connected to a USB POS, you may need to change this setting to enable all scanners to communicate. Options are:

- Table Top Scanner
- Handheld Scanner

To set this feature:

1. Scan the Enter/Exit Programming Mode barcode at the top of the page.
2. Scan your selection from the barcodes below. You'll need to cover any unused barcodes on this and the facing page to ensure that the scanner reads only the barcode you intend to scan.
3. Complete the programming sequence by scanning the Enter/Exit Programming Mode barcode.

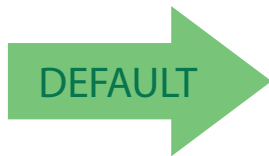

USB OEM Scanner Device Type = Table Top Scanner



USB OEM Scanner Device Type = Handheld Scanner



## USB OEM Additional Interface Options

To set this feature:

1. Scan the Enter/Exit Programming Mode barcode at the top of the page.
2. Scan your selection from the barcodes below. You'll need to cover any unused barcodes on this and the facing page to ensure that the scanner reads only the barcode you intend to scan.

Complete the programming sequence by scanning the Enter/Exit Programming Mode barcode

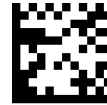

USB OEM Interfaces Option2 =  
Enable scanner at first enumeration after BusReset



USB OEM Interfaces Option2 =  
Disable scanner at first enumeration after BusReset



## RS-232 Interface Features



NOTE

A setting of no parity with 7 data bits is invalid and will default to 8 data bits and no parity.

## RS-232 Baud Rate



RS-232 Baud Rate = 1200



RS-232 Baud Rate = 2400



RS-232 Baud Rate = 4800



RS-232 Baud Rate = 9600



RS-232 Baud Rate = 19200



RS-232 Baud Rate = 38400



## RS-232 Baud Rate (continued)



RS-232 Baud Rate = 57600



RS-232 Baud Rate = 115200



RS-232 Baud Rate = 230400

## RS-232 Number of Data Bits

Specifies number of data bits required for sending and receiving data..



**A setting of 7 data bits with no parity will default to 8 data bits and no parity.**

**NOTE**



RS-232 Number of Data Bits = 7



RS-232 Number of Data Bits = 8



## RS-232 Number of Stop Bits

Specifies number of stop bits required for sending and receiving data

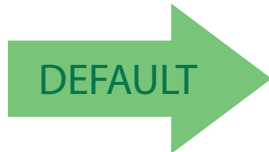

RS-232 Number of Stop Bits = 1



RS-232 Number of Stop Bits = 2



## RS-232 Parity

Specifies parity required for sending and receiving data.

Options for this setting are:

- RS-232 PARITY = NONE
- RS-232 PARITY = EVEN
- RS-232 PARITY = ODD.



**NOTE**

**A setting of no parity with 7 data bits will default to 8 data bits and no parity.**

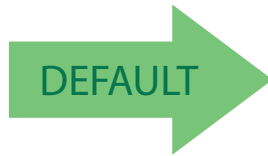

RS-232 Parity = None



RS-232 Parity = Even



RS-232 Parity = Odd

## RS-232 Hardware Control

Enables/disables use of the RS-232 CTS signal for flow control and/or scan control.

Options are:

- Disable — The scanner transmits to the host regardless of any activity on the CTS line.
- Enable CTS Flow Control — The CTS signal controls transmission of data to the host.
- Enable CTS Scan Control — The CTS line must be active for scanner to read and transmit data. While the CTS line is inactive, scanner remains in a host-disabled state; following a successful label transmission, the CTS signal must transition to inactive and then to active to enable scanning for the next label.
- Enable Magellan SL CTS Scan Control — Follows the same hardware protocol as older Magellan SL scanners.

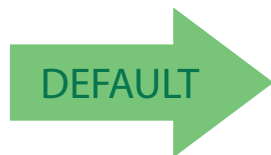

RS-232 Hardware Control = Disable



RS-232 Hardware Control = Enable CTS Flow Control



RS-232 Parity = Enable CTS Scan Control



RS-232 Hardware Control = Enable MGL SL CTS Scan Control



## RS-232 Intercharacter Delay

Specifies delay between the end of one character and the beginning of the next in 10-millisecond increments. This delay is inserted after each data character transmitted. If the transmission speed is too high, the system may not be able to receive all characters. You may need to adjust the delay to make the system work properly.

To set the RS-232 Intercharacter Delay:

1. Scan the Enter/Exit Programming Mode barcode at the top of the page.
2. Scan the barcode below, [Set RS-232 Intercharacter Delay](#).
3. Scan the appropriate digits from the [Alpha-Numeric Keypad in Appendix C](#) that represent the desired delay. The selectable range is 0-100, which is the delay in 10-millisecond increments. Pad all single and double digit numbers with leading zeroes to yield a three-digit entry (000-100).

Examples:

001 = 10ms

005 = 50ms

040 = 400ms

100 = 1,000ms (1 second)

4. The scanner will automatically exit Programming Mode when the appropriate amount of digits have been scanned.



Set RS-232 Intercharacter Delay

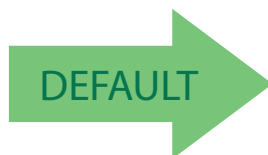

Default setting for this feature is:  
00 - No Intercharacter Delay



## RS-232 Software Flow Control

Enables/disables RS-232 Flow Control using XON/ XOFF characters.



**This item will be ignored when the feature, RS-232 NAK Character, is enabled**

### NOTE

To set this feature:

1. Scan the Enter/Exit Programming Mode barcode at the top of the page.
2. Scan either the enable or disable barcode below. You'll need to cover any unused barcodes on this and the facing page to ensure that the scanner reads only the barcode you intend to scan.
3. Complete the programming sequence by scanning the Enter/Exit Programming Mode barcode.

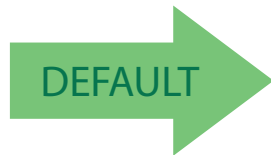

RS-232 Software Flow Control= Disable

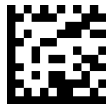

RS-232 Software Flow Control= Enable



### RS-232 Beep on ASCII BEL

Enables/disables ability of scanner to beep (sound a good read tone) on receiving an ASCII BEL (07 hex).

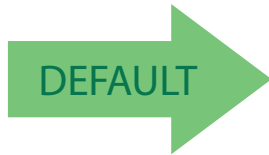

RS-232 Beep on ASCII BEL = Disable



RS-232 Beep on ASCII BEL = Enable

### Beep on Not on File

Select for the host to beep (or not) when a not-on-file condition is detected by the host.



RS-232 Beep on Not on File = Muted



RS-232 Beep on Not on File = Low Volume



RS-232 Beep on Not on File = Medium Volume



RS-232 Beep on Not on File = High Volume

## RS-232 ACK NAK Features

### ACK NAK Enable

This enables/disables the ability of the scanner to support the RS-232 ACK/NAK protocol. When configured, the scanner and/or host sends an “ACK” when it receives data properly, and sends “NAK” when the data is in error. Selections for this option are:

- Disable ACK NAK
- Enable for Label Transmission — the scanner expects an ACK/NAK response from the host when a label is sent)
- Enable for Host Acknowledgement — Enabled for Host Commands (the scanner will respond with ACK/NAK when the host sends a command)
- Enable for Label & Host — Enabled for both Label Transmission & Host Command acknowledgement.

To select the option for RS-232 ACK NAK Enable:

1. Scan the Enter/Exit Programming Mode barcode at the top of the page.
2. Scan the desired option from barcodes below and on the following page. You’ll need to cover any unused barcodes on this and the facing page to ensure that the scanner reads only the barcode you intend to scan.
3. Complete the programming sequence by scanning the Enter/Exit Programming Mode barcode.

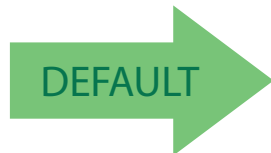

RS-232 ACK NAK = Disable

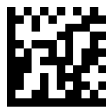

RS-232 ACK NAK = Enable for Label Transmission



RS-232 ACK NAK = Enable for Host Acknowledgement



RS-232 ACK NAK = Enable for Label & Host



### RS-232 ACK Character

This feature specifies which ASCII character will be used as an ACK character.



**NOTE**

**DO NOT set this feature to use previously defined characters such as XON, XOFF or host commands as this will conflict with normal operation of these characters. 8-bit data is not recognized when the feature, RS-232 Number of Data Bits, is set to 7 data bits.**

To specify the RS-232 ACK Character:

1. Scan the Enter/Exit Programming Mode barcode at the top of the page.
2. Scan the barcode, SET RS-232 ACK Character below. You'll need to cover any unused barcodes on this and the facing page to ensure the scanner reads only the barcode you intend to scan.
3. Scan the appropriate digits from the [Alpha-Numeric Keypad in Appendix C](#) that represent the hex designation for the desired character. A table containing the ASCII Character Set and their corresponding Hex Values is available in the inside back cover of this manual. ASCII parameters must be input by scanning a pair of hexadecimal digits for the desired character. For example, if ASCII "A" were the desired ACK character, you would scan the digits "4", then "1" (the ASCII corresponding hex value).
4. The scanner will automatically exit Programming Mode when the appropriate amount of digits/characters have been scanned.



Set RS-232 ACK Character

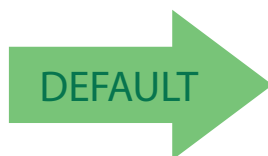

Default setting for this feature is:  
06

## RS-232 NAK Character

This feature specifies which ASCII character will be used as a NAK character.



### NOTE

**DO NOT set this feature to use previously defined characters such as XON, XOFF or host commands as this will conflict with normal operation of these characters. 8-bit data is not recognized when the feature, RS-232 Number of Data Bits, is set to 7 data bits.**

To specify the RS-232 NAK Character:

1. Scan the Enter/Exit Programming Mode barcode at the top of the page.
2. Scan the barcode, SET RS-232 NAK Character below. You'll need to cover any unused barcodes on this and the facing page to ensure the scanner reads only the barcode you intend to scan.
3. Scan the appropriate digits from the [Alpha-Numeric Keypad in Appendix C](#) that represent the hex designation for the desired character. A table containing the ASCII Character Set and their corresponding Hex Values is available in the inside back cover of this manual. ASCII parameters must be input by scanning a pair of hexadecimal digits for the desired character. For example, if ASCII "A" were the desired NAK character, you would scan the digits "4", then "1" (the ASCII corresponding hex value).
4. The scanner will automatically exit Programming Mode when the appropriate amount of digits/characters have been scanned.



Set RS-232 NAK Character

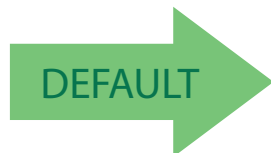

Default setting for this feature is:  
15



### RS-232 Retry on ACK NAK Timeout

This option specifies the action scanner performs on expiration of the RS-232 ACK NAK Timeout Value.



RS-232 Retry on ACK NAK Timeout = Disable



RS-232 Retry on ACK NAK Timeout = Enable

## RS-232 ACK NAK Timeout Value

This item specifies the time the scanner will wait for an ACK character from the host following a label transmission.

- 0 = Infinite timeout
- 1 - 75 = Timeout in 200-millisecond increments

To set the ACK NAK Timeout Value:

1. Scan the Enter/Exit Programming Mode barcode at the top of the page.
2. Scan the barcode below, [Set RS-232 ACK NAK Timeout Value](#). You'll need to cover any unused barcodes on this and the facing page to ensure that the scanner reads only the barcode you intend to scan.
3. Scan the appropriate digits from the [Alpha-Numeric Keypad in Appendix C](#) that represent the desired timeout. A setting of 0 specifies an infinite timeout. The remaining selectable range is 1-75, which is the timeout in 200-millisecond increments. Pad all single digit numbers with a leading zero to yield a two-digit entry (00-75).

Examples:

00 = Infinite timeout

01 = 200ms

05 = 1,000ms (1 second)

40 = 8,000ms (8 seconds)

75 = 15,000ms (15 seconds)

The scanner will automatically exit Programming Mode when the appropriate amount of digits have been scanned.



Set RS-232 ACK NAK Timeout Value

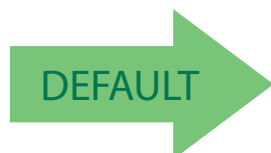

Default setting for this feature is:  
01 - 200ms



### RS-232 ACK NAK Retry Count

This feature sets the number of times for the scanner to retry a label transmission under a retry condition.

To set the RS-232 ACK NAK Retry Count:

1. Scan the Enter/Exit Programming Mode barcode at the top of the page.
2. Scan the barcode, [Set RS-232 ACK NAK Retry Count](#) below. You'll need to cover any unused barcodes on this and the facing page to ensure that the scanner reads only the barcode you intend to scan.
3. Scan the appropriate digits from the [Alpha-Numeric Keypad in Appendix C](#) that represent the desired number. The selectable range is 000-255 resets. Pad all single and double digit numbers with leading zeroes to yield a three-digit entry (000-255).



**A setting of 255 specifies "retry forever."**

#### NOTE

4. The scanner will automatically exit Programming Mode when the appropriate amount of digits have been scanned.



Set RS-232 ACK NAK Retry Count

Default setting for this feature is:  
003 - Three retries

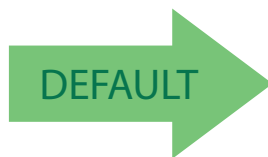



## RS-232 ACK NAK Error Handling

This item specifies the method the scanner will use to handle errors detected while waiting to receive the ACK character from the host. Errors include unrecognized host commands and communication errors such as parity or framing errors.

- Ignore Errors (recommended setting)
- Assume ACK (risk of lost label data)
- Assume NAK (risk of duplicate label)

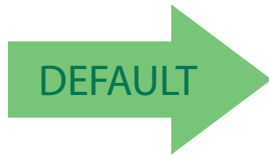

RS-232 ACK NAK Error Handling = Ignore Errors

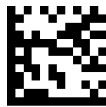

RS-232 ACK NAK Error Handling = Assume ACK



RS-232 ACK NAK Error Handling = Assume NAK



## RS-232 Indicate Transmission Failure

This feature enables / disables the ability of the scanner to sound a bad label beep indication when a transmission failure occurs.

To set this feature:

1. Scan the Enter/Exit Programming Mode barcode at the top of the page.
2. Scan the desired option from the barcodes below. You'll need to cover any unused barcodes on this and the facing page to ensure that the scanner reads only the barcode you intend to scan.
3. Complete the programming sequence by scanning the Enter/Exit Programming Mode barcode.



RS-232 Indicate Transmission Failure = Disable



RS-232 Indicate Transmission Failure = Enable





# Data Editing

<b>DATA EDITING OVERVIEW</b> starting on page 98
<b>GLOBAL PREFIX/SUFFIX</b> starting on page 99 <ul style="list-style-type: none"><li>•Global Prefix on page 99</li><li>•Global Suffix on page 100</li></ul>
<b>AIM ID</b> starting on page 101
<b>LABEL ID</b> starting on page 102 <ul style="list-style-type: none"><li>•Label ID Control on page 102</li><li>•Setting Label ID on page 103</li><li>•1D Symbologies – Label ID on page 104</li><li>•2D Symbologies on page 110</li><li>•Postal Codes on page 112</li></ul>
<b>CASE CONVERSION</b> starting on page 114
<b>CHARACTER CONVERSION</b> starting on page 115

## Data Editing Overview

When a barcode is scanned, additional information can be sent to the host computer along with the barcode data. This combination of barcode data and supplementary user-defined data is called a “message string.” The features in this chapter can be used to build specific user-defined data into a message string.

There are several types of selectable data characters that can be sent before and after scanned data. You can specify if they should be sent with all symbologies, or only with specific symbologies. [Figure 5](#) shows the available elements you can add to a message string:

**Figure 5. Breakdown of a Message String**

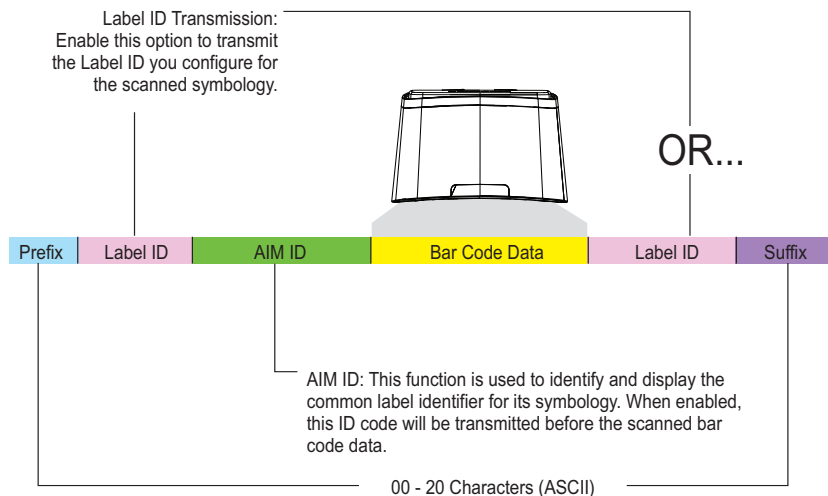

### Please Keep In Mind...

- Modifying a message string is not a mandatory requirement. Data editing is a sophisticated feature allowing highly customizable output for advanced users. Factory default settings for data editing is typically set to NONE.
- A prefix or suffix may be applied (reference the [1D Symbologies](#) chapter for these settings) or across all symbologies (set via the Global features in this chapter).
- You can add any character from the [ASCII Character Set](#) (from 00–FF) on the inside back cover of this manual as a prefix, suffix or Label ID.
- Enter prefixes and suffixes in the order in which you want them to appear on the output.

## Global Prefix/Suffix

### Global Prefix

This feature applies to RS-232 (Standard or Wincor-Nixdorf), USB-COM, USB-TEC, and USB Keyboard interfaces. It specifies the prefix that is added to the beginning of label transmission.

To specify the Global Prefix Character(s):

1. Scan the Enter/Exit Programming Mode barcode at the top of the page.
2. Scan the barcode Set Global Prefix below. Cover any unused barcodes to ensure the scanner reads only the barcode you intend to scan.
3. Scan the appropriate characters/digits from the [Alpha-Numeric Keypad on page 296](#) that represent the hex designation for the desired character(s). The ASCII Character Set and their corresponding Hex Values are in the inside back cover of this manual. ASCII parameters must be input by scanning a pair of hexadecimal digits for each character. To set a two-character value of AB, barcodes containing the digits '4', '1', '4', and '2' must be scanned. The selectable range for this option is any hex value from 00 to FF. Up to 20 hex pairs can be designated.



To specify "No Global Prefix," scan 00

#### NOTE

4. If designating the full 20 hex pairs, the scanner will exit Programming Mode when the appropriate amount of digits have been scanned. If designating less than 20 hex pairs, you can end the programming sequence early by scanning the Terminate Sequence barcode.
5. Complete the programming sequence by scanning the Enter/Exit Programming Mode barcode.



Set Global Prefix



Terminate Sequence

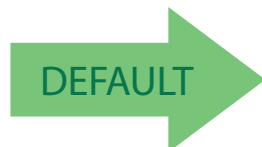

Default setting for this feature is:  
00 - No Global Prefix



## Global Suffix

This feature applies to RS-232 (Standard or Wincor-Nixdorf), USB-COM, USB-TEC, and USB Keyboard interfaces. It specifies the suffix that is added to end of a label transmission. Three standard options are available below. Contact your dealer for other alternate settings for this feature.

- No Global Suffix
- CR — Carriage Return
- CR LF — Carriage Return, Line Feed

To set the Global Suffix:

1. Scan the Enter/Exit Programming Mode barcode at the top of the page.
2. Scan your selection from the barcodes below.
3. Complete the programming sequence by scanning the Enter/Exit Programming Mode barcode.



Global Suffix = No Global Suffix



Global Suffix = CR



Global Suffix = CR LF

## AIM ID

AIM (Automatic Identification Manufacturers) label identifiers are assigned from a globally standardized list — as opposed to custom label ID characters you select yourself — and can be included with scanned barcode data. AIM label identifiers consist of three characters as follows:

- A close brace character (ASCII ‘}’), followed by...
- A code character (see the table below), followed by...
- A modifier character (the modifier character is symbol dependent)

SYMBOLGY	CHAR	SYMBOLGY	CHAR	SYMBOLGY	CHAR
UPC/EAN	E	GS1 Omnidirectional, GS1 Expanded	e	Plessey	P
Code 39	A	Standard 2 of 5	S	QR Code and Micro QR	Q
Codabar	F	ISBN	X <sup>a</sup>	Aztec	z
Interleaved 2 of 5	I	Datamatrix	d	Code 11	H
Code 93	G	PDF417 and MicroPDF	L		
Code 128/EAN 128	C	MSI Plessey	M		

a. ISBN (X with a 0 modifier character). X is used for all unknown label types.

**Figure 6. AIM ID**

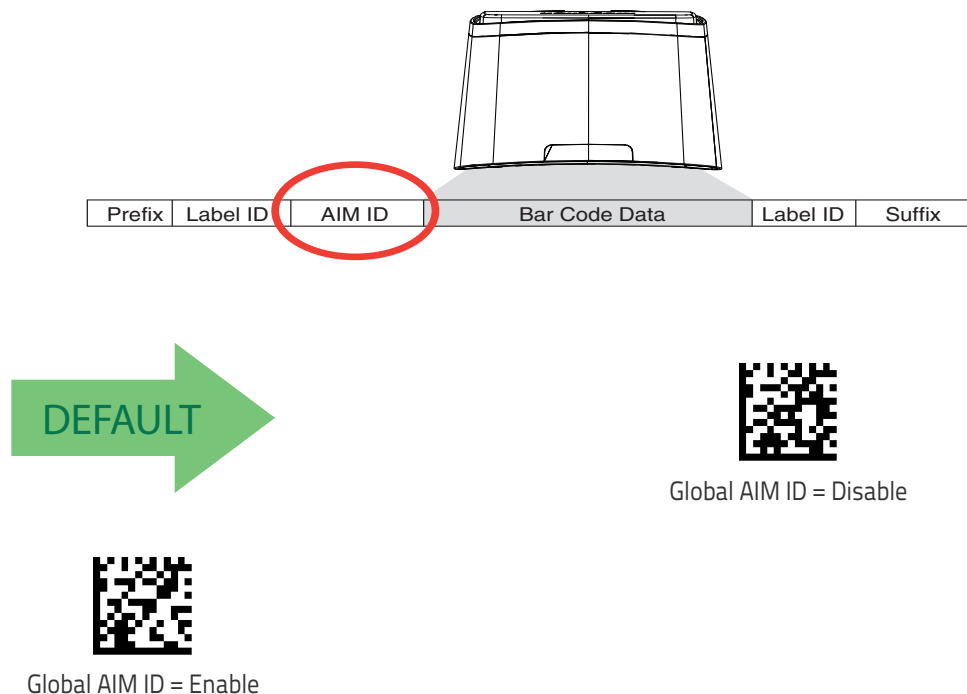



## Label ID

### Label ID Control

This feature specifies whether or not Label IDs are transmitted to the host and if so, whether to attach them as a prefix or suffix.

Choices are:

- Disable
- Enable as a Prefix
- Enable as a Suffix

To select the option for Label ID Control:

1. Scan the Enter/Exit Programming Mode barcode at the top of the page.
2. Scan the desired option from the barcodes below. You'll need to cover any unused barcodes on this and the facing page to ensure that the scanner reads only the barcode you intend to scan.
3. Complete the programming sequence by scanning the Enter/Exit Programming Mode barcode.



Label ID Control = Disable



Label ID Control = Enable as a Prefix



Label ID Control = Enable as a Suffix



## Setting Label ID

This feature allows the setting of custom Label ID character(s) for each available symbology type if other than the default Label ID is desired.







To set this feature:

1. Scan the Enter/Exit Programming Mode barcode at the top of the page.
2. Scan the barcode for the desired symbology. You'll need to cover any unused barcodes on this and the facing page to ensure the scanner reads only the barcode you intend to scan.
3. Scan the appropriate digits from the [Alpha-Numeric Keypad on page 296](#) that represent the desired Label ID characters; entered as two hex pairs. A table containing the ASCII Character Set and their corresponding Hex Values is available in the inside back cover of this manual. ASCII parameters must be input by scanning a pair of hexadecimal digits for each character. Thus, to set a two-character value of AB, barcodes containing the digits '4', '1', '4', and '2' must be scanned. The selectable range for this option is any hex value from 00 to FF.

Complete the programming sequence by scanning the Enter/Exit Programming Mode barcode.



## 1D Symbologies - Label ID

<p>Default Label ID for this symbology is: 6F = o</p>	 <p>Anker Plessey Label ID</p>
 <p>Codabar Label ID</p>	<p>Default Label ID for this symbology is: 25 = %</p>
<p>Default Label ID for this symbology is: 23 = #</p>	 <p>Code 128 Label ID</p>
 <p>Code 128 ISBT Label ID</p>	<p>Default Label ID for this symbology is: 66 = f</p>
<p>Default Label ID for this symbology is: 41 = A</p>	 <p>Code 32 Label ID</p>
 <p>Code 39 Label ID</p>	<p>Default Label ID for this symbology is: 2A = *</p>
<p>Default Label ID for this symbology is: 59 = Y</p>	 <p>Code 39 CIP Label ID</p>



1D Symbologies (continued)	
 Code39 Danish PPT Label ID	Default Label ID for this symbology is: 2459 = \$Y
Default Label ID for this symbology is: 2459 = \$Y	 Code39 LaPoste Label ID
 Code39 PZN Label ID	Default Label ID for this symbology is: 245A = \$Z
Default Label ID for this symbology is: 26 = &	 Code 93 Label ID
 DataBar Expanded Composite Label ID	Default Label ID for this symbology is: 5258 = RX
Default Label ID for this symbology is: 5258 = RX	 DataBar Expanded Label ID
 DataBar Limited Composite Label ID	Default Label ID for this symbology is: 5258 = RX
Default Label ID for this symbology is: 5258 = RX	 DataBar Limited Label ID



**1D Symbologies (continued)**

Default Label ID for this symbology is:  
5234 = R4



DataBar Omnidirectional Composite Label ID



DataBar Omnidirectional Label ID

Default Label ID for this symbology is:  
5234 = R4

Default Label ID for this symbology is:  
50 = P



EAN 128 Label ID



EAN-13 2-Digit Supplemental Label ID

Default Label ID for this symbology is:  
46 = F

Default Label ID for this symbology is:  
46 = F



EAN-13 5-Digit Supplemental Label ID



EAN-13 Label ID

Default Label ID for this symbology is:  
46 = F

Default Label ID for this symbology is:  
46 = F



EAN-13 Composite Label ID





EAN-8 2-Digit Supplemental Label ID

Default Label ID for this symbology is:  
4646 = FF



**1D Symbologies (continued)**

 <p>EAN-8 5-Digit Supplemental Label ID</p>	<p>Default Label ID for this symbology is: 4646 = FF</p>
<p>Default Label ID for this symbology is: 4646 = FF</p>	 <p>EAN-8 Label ID</p>
 <p>EAN-8 Composite Label ID</p>	<p>Default Label ID for this symbology is: 4646 = FF</p>
<p>Default Label ID for this symbology is: 4F = 0</p>	 <p>Follett 2 of 5 Label ID</p>
 <p>GTIN 2-Digit Supplemental Label ID</p>	<p>Default Label ID for this symbology is: 4732 = G2</p>
<p>Default Label ID for this symbology is: 4735 = G5</p>	 <p>GTIN 5-Digit Supplemental Label ID</p>
 <p>GTIN Label ID</p>	<p>Default Label ID for this symbology is: 47 = G</p>
<p>Default Label ID for this symbology is: 69 = i</p>	 <p>I 2 of 5 Label ID</p>



**1D Symbolologies (continued)**



12 of 5 IATA Label ID

Default Label ID for this symbology is:  
4941 = IA

Default Label ID for this symbology is:  
65 = e



12 of 5 CIP HR Label ID



ISBN Label ID

Default Label ID for this symbology is:  
49 = I

Default Label ID for this symbology is:  
6E = n



ISSN Label ID



MSI Label ID

Default Label ID for this symbology is:  
40 = @

Default Label ID for this symbology is:



Plessey Label ID







Standard 2 of 5 Label ID

Default Label ID for this symbology is:  
73 = s

Default Label ID for this symbology is:  
2454 = \$T



Trioptic Label ID

<b>1D Symbologies (continued)</b>	
Default Label ID for this symbology is: 41 = A	 UPC-A Label ID
 UPC-A 2-Digit Supplemental Label ID	Default Label ID for this symbology is: 41 = A
Default Label ID for this symbology is: 41 = A	 UPC-A 5-Digit Supplemental Label ID
 UPCA Composite Label ID	Default Label ID for this symbology is: 41 = A
Default Label ID for this symbology is: 45 = E	 UPC-E 2-Digit Supplemental Label ID
 UPC-E 5-Digit Supplemental Label ID	Default Label ID for this symbology is: 45 = E
Default Label ID for this symbology is: 45 = E	 UPC-E Label ID
 UPCE Composite Label ID	Default Label ID for this symbology is: 45 = E



## 2D Symbologies

	Default Label ID for this symbology is: 417A = Az
Aztec Label ID	
Default Label ID for this symbology is: 446D = Dm	Data Matrix Label ID
	Default Label ID for this symbology is: 2464 = \$d
Dotcode Label ID	
Default Label ID for this symbology is: 4467 = Dg	GS1 Data Matrix label ID
	Default Label ID for this symbology is: 5147 = QG
GS1 QR Code label ID	
Default Label ID for this symbology is: 2453 = \$S	Han Xin Label ID
	Default Label ID for this symbology is: 6D50 = mP
Micro PDF 417 Label ID	
Default Label ID for this symbology is: 2451 = \$Q	Micro QR Code Label ID



**2D Symbologies (continued)**



PDF 417 Label ID

Default Label ID for this symbology is:  
50 = P

Default Label ID for this symbology is:  
5152 = QR



QR Code Label ID



## Postal Codes

<p>Default Label ID for this symbology is: 244C = \$L</p>	 Postnet Label ID
 Planet Code Label ID	<p>Default Label ID for this symbology is: 2457 = \$W</p>
<p>Default Label ID for this symbology is: 244D = \$M</p>	 Royal Mail Label ID
 Kix Label ID	<p>Default Label ID for this symbology is: 2455 = \$U</p>
<p>Default Label ID for this symbology is: 244B = \$K</p>	 Australia Post Label ID
 Japan Post Label ID	<p>Default Label ID for this symbology is: 2452 = \$R</p>
<p>Default Label ID for this symbology is: 2456 = \$V</p>	 IMB Label ID
 Sweden Post Label ID	<p>Default Label ID for this symbology is: 2458 = \$X</p>
<p>Default Label ID for this symbology is: 2450 = \$P</p>	 Portugal Post Label ID

## Global Mid-Label ID

This feature specifies a global mid-label ID that is added between two barcodes for transmission.

To set this feature:

1. Scan the Enter/Exit Programming Mode barcode at the top of the page.
2. Scan the barcode “Set Global Mid-Label ID” below. You’ll need to cover any unused barcodes on this and the facing page to ensure the scanner reads only the barcode you intend to scan.
3. Scan the appropriate digits from the Alpha-Numeric Keypad in [Appendix C](#) that represent the desired mid-label ID characters; entered as two hex pairs. A table containing the ASCII Character Set and their corresponding Hex Values is available in the inside back cover of this manual. ASCII parameters must be input by scanning a pair of hexadecimal digits for each character. Thus, to set a two-character value of AB, barcodes containing the digits ‘4’, ‘1’, ‘4’, and ‘2’ must be scanned. The selectable range for this option is any hex value from 00 to FF.

Complete the programming sequence by scanning the Enter/Exit Programming Mode barcode.



Set Global Mid-Label ID

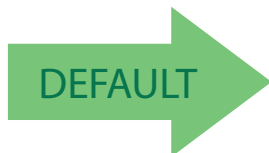

Default Label ID for this symbology is:  
00 = No Global Mid-label ID



## Case Conversion

This option can change the case of all alphabetic characters in scanned barcode data to upper or lower case.



**NOTE**

Case conversion affects **ONLY** scanned barcode data, and does not affect Label ID, Prefix, Suffix, or other appended data.

To set this feature:

1. Scan the Enter/Exit Programming Mode barcode at the top of the page.
2. Scan barcode for the desired option below. You'll need to cover any unused barcodes on this and the facing page to ensure that the scanner reads only the barcode you intend to scan.
3. Complete the programming sequence by scanning the Enter/Exit Programming Mode barcode.

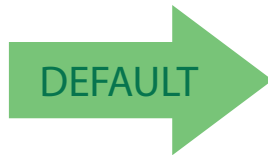

Case Conversion = No Case Conversion



Case Conversion = Upper Case



Case Conversion = Lower Case

## Character Conversion

Character conversion is an eight byte configuration item. The eight bytes are 4 character pairs represented in hexadecimal ASCII values. The first character in the pair is the character that will be converted. The second character in the pair is the character to convert to. If the character to convert in a pair is FF, then no conversion is done.

For example, if you have the character conversion configuration item set to the following:

41423132FFFFFFF

The first pair is 4142 or AB (41 hex is an ASCII capital A, 42 hex is an ASCII capital B) and the second pair is 3132 or 12 (31 hex is an ASCII 1, 32 is an ASCII 2). The other two pairs are FFFF and FFFF.

With the label, AG15TA81, it would look as follows after the character conversion: BG25TB82.

The A characters were converted to the B character and the 1 characters were converted to the numeral 2 character. Nothing is done with the last two character pairs, since they are all FF.

To set Character Conversion:

1. Scan the Enter/Exit Programming Mode barcode at the top of the page.
2. Scan the Character Conversion barcode.
3. Determine the desired string. Up to sixteen positions can be determined as in the above example. Next, turn to the ASCII Chart on the inside back cover of this manual and find the equivalent hex digits needed to fulfill the string.



### NOTE

The positions not used must be filled with the character 'F'.

4. Turn to the [Alpha-Numeric Keypad on page 296](#) and scan the barcodes representing the hex characters determined in the previous step. When the last character is scanned, the scanner will sound a triple beep.
5. Complete the programming sequence by scanning the Enter/Exit Programming Mode barcode.



Set Character Conversion

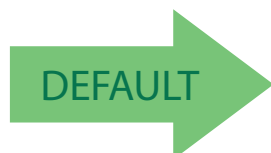

Default setting for this feature is:  
FFFFFFFFFFFFFFFF (No Character Conversion)



# 1D Symbology Programming

## 1D Symbologies



### NOTE

If the scanner's interface type must be changed, always be sure that interface configuration is the **FIRST** item scanned during a programming session. (Selecting an interface type resets **ALL** other configuration items — including symbology programming — to the factory default for that interface type.)

The following pages contain configuration information concerning the various barcode types (symbologies) the scanner supports.

<b>COUPON CONTROL</b> starting on page 117
<b>UPC-A</b> starting on page 120
<b>UPC-E</b> starting on page 125
<b>EAN-13</b> starting on page 131
<b>EAN-8</b> starting on page 136
<b>OTHER UPC/EAN OPTIONS</b> starting on page 148
<b>GTIN</b> starting on page 169
<b>GS1 DATABAR</b> starting on page 170
<b>DATABAR OMNIDIRECTIONAL</b> starting on page 170
<b>DATABAR LIMITED</b> starting on page 175
<b>DATABAR EXPANDED</b> starting on page 179
<b>CODE 39</b> starting on page 187
<b>CODE 32 ITALIAN PHARMACODE</b> starting on page 198
<b>CODE 128</b> starting on page 201
<b>EAN-128</b> starting on page 209
<b>INTERLEAVED 2 OF 5 (I 2 OF 5)</b> starting on page 210
<b>CODABAR</b> starting on page 217
<b>CODE 93</b> starting on page 228
<b>MSI</b> starting on page 233
<b>STANDARD 2 OF 5</b> starting on page 241

## Coupon Control

### Coupon Control Enable

This feature is used to control the method of processing coupon labels. For the purposes of this feature, coupon labels are defined as:

1. UPC-A labels that start with a '5'
2. GS1 DataBar Expanded labels that start with '8110'

**Enable UPC-A Coupons** — UPCA coupon labels will decode but RSS/Databar Expanded coupon labels will not. RSS/Databar Expanded labels that are not coupon labels will decode and all UPCA labels will decode.

**Enable GS1 DataBar Expanded Coupons** — RSS/Databar Expanded coupon labels will decode but UPCA coupon labels will not. UPCA labels that are not coupon labels and all RSS/Databar Expanded labels will decode.

**Priority to UPC-A Coupons** — UPCA coupon labels will be given priority.

**Priority to GS1 DataBar Expanded Coupons** — Databar coupon labels will be given priority.

To set this feature:

1. Scan the Enter/Exit Programming Mode barcode at the top of the page.
2. Scan your choice from the Coupon Control selections below. You'll need to cover any unused barcodes on this and the facing page to ensure that the scanner reads only the barcode you intend to scan.
3. Complete the programming sequence by scanning the Enter/Exit Programming Mode barcode.



Coupon Control = Disable



Coupon Control = Enable UPC-A Coupons

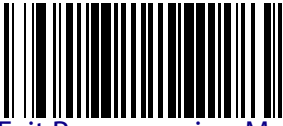

### Coupon Control Enable (continued)



Coupon Control = Enable GS1 DataBar Expanded Coupons



Coupon Control = Priority to UPC-A Coupons

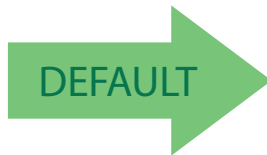

Coupon Control = Priority to GS1 DataBar Expanded Coupons



## Coupon Label Priority Timer

This feature sets the duration of the UPCA / DataBar coupon label priority timer.  
To set this feature:

1. Scan the Enter/Exit Programming Mode barcode at the top of the page.
2. Scan your selection from the barcodes below. You'll need to cover any unused barcodes on this and the facing page to ensure that the scanner reads only the barcode you intend to scan.
3. Complete the programming sequence by scanning the Enter/Exit Programming Mode barcode.



Coupon Label Priority Timer = 0.1 Seconds



Coupon Label Priority Timer = 0.2 Seconds



Coupon Label Priority Timer = 0.3 Seconds



Coupon Label Priority Timer = 0.4 Seconds



Coupon Label Priority Timer = 0.5 Second



Coupon Label Priority Timer = 1 Second

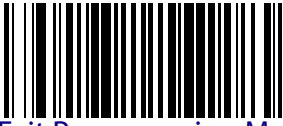

## UPC-A

### UPC-A Enable

Enables/disables the ability of the scanner to decode UPC-A labels.

To set this feature:

1. Scan the Enter/Exit Programming Mode barcode at the top of the page.
2. Scan either the enable or disable barcode below. You'll need to cover any unused barcodes on this and the facing page to ensure that the scanner reads only the barcode you intend to scan.
3. Complete the programming sequence by scanning the Enter/Exit Programming Mode barcode.



UPC-A = Disable



UPC-A = Enable



## UPC-A Number System Character Transmission

Enables/disables transmission of a UPC-A number system character.



This item is ignored when the advanced feature, Full Label Edit, is enabled.

### NOTE

To set this feature:

1. Scan the Enter/Exit Programming Mode barcode at the top of the page.
2. Scan either the enable or disable barcode below. You'll need to cover any unused barcodes on this and the facing page to ensure that the scanner reads only the barcode you intend to scan.
3. Complete the programming sequence by scanning the Enter/Exit Programming Mode barcode.



UPC-A Number System Character Transmission =  
Disable



UPC-A Number System Character Transmission = Enable



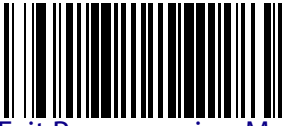

## UPC-A Check Character Transmission

Enables/disables transmission of a UPC-A check character.



This item is ignored when the advanced feature, Full Label Edit, is enabled.

### NOTE

To set this feature:

1. Scan the Enter/Exit Programming Mode barcode at the top of the page.
2. Scan either the enable or disable barcode below. You'll need to cover any unused barcodes on this and the facing page to ensure that the scanner reads only the barcode you intend to scan.
3. Complete the programming sequence by scanning the Enter/Exit Programming Mode barcode.



UPC-A Check Character Transmission = Disable



UPC-A Check Character Transmission = Enable



## UPC-A Minimum Read

This feature specifies the minimum number of consecutive UPC-A decodes before is accepted as good read.

To set this feature:

1. Scan the Enter/Exit Programming Mode barcode at the top of the page.
2. Scan your selection from the barcodes below. You'll need to cover any unused barcodes on this and the facing page to ensure that the scanner reads only the barcode you intend to scan.
3. Complete the programming sequence by scanning the ENTER/EXIT Programming Mode barcode.

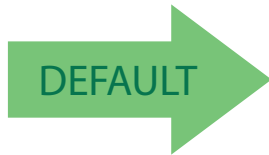

UPC-A Minimum Read = 1



UPC-A Minimum Read = 2



UPC-A Minimum Read = 3



UPC-A Minimum Read = 4

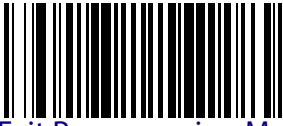

## Expand UPC-A to EAN-13

Enables/disables expansion of UPC-A labels to EAN/JAN-13.

To set this feature:

1. Scan the Enter/Exit Programming Mode barcode at the top of the page.
2. Scan either the enable or disable barcode below. You'll need to cover any unused barcodes on this and the facing page to ensure that the scanner reads only the barcode you intend to scan.
3. Complete the programming sequence by scanning the Enter/Exit Programming Mode barcode.

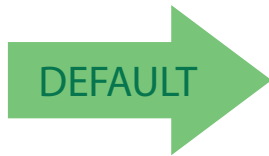

Expand UPC-A to EAN-13 = Disable



Expand UPC-A to EAN-13 = Enable

## UPC-E

### UPC-E Enable

Enables/disables the ability of the scanner to decode UPC-E labels.

To set this feature:

1. Scan the Enter/Exit Programming Mode barcode at the top of the page.
2. Scan either the enable or disable barcode below. You'll need to cover any unused barcodes on this and the facing page to ensure that the scanner reads only the barcode you intend to scan.
3. Complete the programming sequence by scanning the Enter/Exit Programming Mode barcode.



UPC-E = Disable



UPC-E = Enable



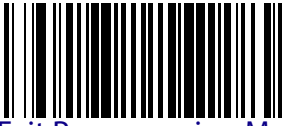

## UPC-E Number System Character Transmission

Enables/disables transmission of a UPC-E number system character.



This item is ignored when the advanced feature, Full Label Edit, is enabled.

### NOTE

To set this feature:

1. Scan the Enter/Exit Programming Mode barcode at the top of the page.
2. Scan either the enable or disable barcode below. You'll need to cover any unused barcodes on this and the facing page to ensure that the scanner reads only the barcode you intend to scan.
3. Complete the programming sequence by scanning the Enter/Exit Programming Mode barcode.



UPC-E Number System Character Transmission = Disable



UPC-E Number System Character Transmission = Enable





## UPC-E Check Character Transmission

Enables/disables transmission of a UPC-E check character.



This item is ignored when the advanced feature, Full Label Edit, is enabled.

### NOTE

To set this feature:

1. Scan the Enter/Exit Programming Mode barcode at the top of the page.
2. Scan either the enable or disable barcode below. You'll need to cover any unused barcodes on this and the facing page to ensure that the scanner reads only the barcode you intend to scan.
3. Complete the programming sequence by scanning the Enter/Exit Programming Mode barcode.



UPC-E Check Character Transmission = Disable



UPC-E Check Character Transmission = Enable



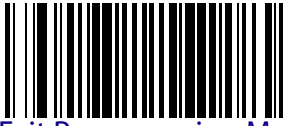

## Expand UPC-E to UPC-A

Enables/disables expansion of UPC-E labels to UPC-A.

To set this feature:

1. Scan the Enter/Exit Programming Mode barcode at the top of the page.
2. Scan either the enable or disable barcode below. You'll need to cover any unused barcodes on this and the facing page to ensure that the scanner reads only the barcode you intend to scan.
3. Complete the programming sequence by scanning the Enter/Exit Programming Mode barcode.

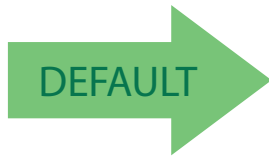

Expand UPC-E to UPC-A = Disable

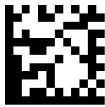

Expand UPC-E to UPC-A = Enable

## Expand UPC-E to EAN-13

Enables/disables expansion of UPC-E labels to EAN/JAN-13.

To set this feature:

1. Scan the Enter/Exit Programming Mode barcode at the top of the page.
2. Scan either the enable or disable barcode below. You'll need to cover any unused barcodes on this and the facing page to ensure that the scanner reads only the barcode you intend to scan.
3. Complete the programming sequence by scanning the Enter/Exit Programming Mode barcode.

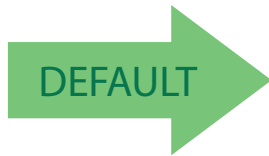

Expand UPC-E to EAN-13 = Disable

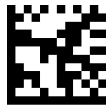

Expand UPC-E to EAN-13 = Enable

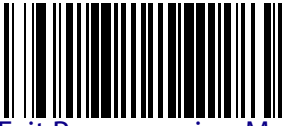

## UPC-E Minimum Read

This feature specifies the minimum number of consecutive UPC-E decodes before is accepted as good read.

To set this feature:

1. Scan the Enter/Exit Programming Mode barcode at the top of the page.
2. Scan your selection from the barcodes below. You'll need to cover any unused barcodes on this and the facing page to ensure that the scanner reads only the barcode you intend to scan.
3. Complete the programming sequence by scanning the ENTER/EXIT Programming Mode barcode.

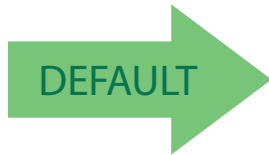

UPC-E Minimum Read = 1



UPC-E Minimum Read = 2



UPC-E Minimum Read = 3



UPC-E Minimum Read = 4

## EAN-13

### EAN-13 Enable

Enables/disables the ability of the scanner to decode EAN/JAN-13 labels.  
To set this feature:

1. Scan the Enter/Exit Programming Mode barcode at the top of the page.
2. Scan either the enable or disable barcode below. You'll need to cover any unused barcodes on this and the facing page to ensure that the scanner reads only the barcode you intend to scan.
3. Complete the programming sequence by scanning the Enter/Exit Programming Mode barcode.



EAN-13 = Disable



EAN-13 = Enable



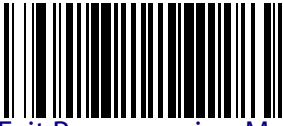

## EAN-13 First Character Transmission

Enables/disables transmission of EAN/JAN-13 first character.



This item is ignored when the advanced feature, Full Label Edit, is enabled.

### NOTE

To set this feature:

1. Scan the Enter/Exit Programming Mode barcode at the top of the page.
2. Scan either the enable or disable barcode below. You'll need to cover any unused barcodes on this and the facing page to ensure that the scanner reads only the barcode you intend to scan.
3. Complete the programming sequence by scanning the Enter/Exit Programming Mode barcode.



EAN-13 First Character Transmission = Disable



EAN-13 First Character Transmission = Enable



## EAN-13 Check Character Transmission

Enables/disables transmission of an EAN/JAN-13 check character.



This item is ignored when the advanced feature, Full Label Edit, is enabled.

### NOTE

To set this feature:

1. Scan the Enter/Exit Programming Mode barcode at the top of the page.
2. Scan either the enable or disable barcode below. You'll need to cover any unused barcodes on this and the facing page to ensure that the scanner reads only the barcode you intend to scan.
3. Complete the programming sequence by scanning the Enter/Exit Programming Mode barcode.



EAN-13 Check Character Transmission = Disable



EAN-13 Check Character Transmission = Enable



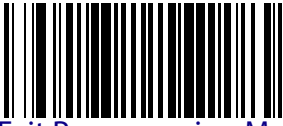

## EAN-13 ISBN Conversion Enable

Enables/disables conversion of EAN/JAN-13 labels starting with 978 to Bookland ISBN labels.

To set this feature:

1. Scan the Enter/Exit Programming Mode barcode at the top of the page.
2. Scan either the enable or disable barcode below. You'll need to cover any unused barcodes on this and the facing page to ensure that the scanner reads only the barcode you intend to scan.
3. Complete the programming sequence by scanning the Enter/Exit Programming Mode barcode.

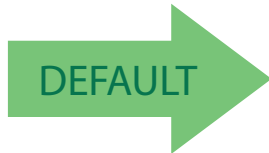

EAN-13 ISBN Conversion = Disable



EAN-13 ISBN Conversion = Enable



## EAN-13 Minimum Read

This feature specifies the minimum number of consecutive EAN-13 decodes before is accepted as good read.

To set this feature:

1. Scan the Enter/Exit Programming Mode barcode at the top of the page.
2. Scan your selection from the barcodes below. You'll need to cover any unused barcodes on this and the facing page to ensure that the scanner reads only the barcode you intend to scan.
3. Complete the programming sequence by scanning the ENTER/EXIT Programming Mode barcode.

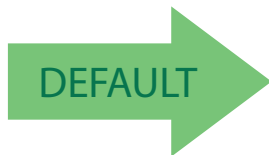

EAN-13 Minimum Read = 1



EAN-13 Minimum Read = 2



EAN-13 Minimum Read = 3



EAN-13 Minimum Read = 4



## EAN-8

### EAN-8 Enable

Enables/disables the ability of the scanner to decode EAN/JAN-8 labels.

To set this feature:

1. Scan the Enter/Exit Programming Mode barcode at the top of the page.
2. Scan either the enable or disable barcode below. You'll need to cover any unused barcodes on this and the facing page to ensure that the scanner reads only the barcode you intend to scan.
3. Complete the programming sequence by scanning the Enter/Exit Programming Mode barcode.



EAN-8 = Disable



EAN-8 = Enable



## EAN-8 Check Character Transmission

Enables/disables transmission of an EAN/JAN-8 check character.



This item is ignored when the advanced feature, Full Label Edit, is enabled.

### NOTE

To set this feature:

1. Scan the Enter/Exit Programming Mode barcode at the top of the page.
2. Scan either the enable or disable barcode below. You'll need to cover any unused barcodes on this and the facing page to ensure that the scanner reads only the barcode you intend to scan.
3. Complete the programming sequence by scanning the Enter/Exit Programming Mode barcode.



EAN-8 Check Character Transmission = Disable



EAN-8 Check Character Transmission = Enable



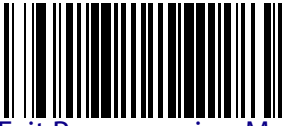

## Expand EAN-8 to EAN-13

Enables/disables expansion of EAN/JAN-8 labels to EAN/JAN-13.

To set this feature:

1. Scan the Enter/Exit Programming Mode barcode at the top of the page.
2. Scan either the enable or disable barcode below. You'll need to cover any unused barcodes on this and the facing page to ensure that the scanner reads only the barcode you intend to scan.
3. Complete the programming sequence by scanning the Enter/Exit Programming Mode barcode.

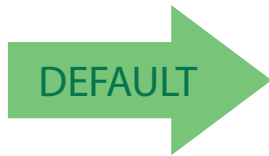

Expand EAN-8 to EAN-13 = Disable



Expand EAN-8 to EAN-13 = Enable

## EAN-8 Minimum Read

This feature specifies the minimum number of consecutive EAN-8 decodes before is accepted as good read.

To set this feature:

1. Scan the Enter/Exit Programming Mode barcode at the top of the page.
2. Scan your selection from the barcodes below. You'll need to cover any unused barcodes on this and the facing page to ensure that the scanner reads only the barcode you intend to scan.
3. Complete the programming sequence by scanning the ENTER/EXIT Programming Mode barcode.

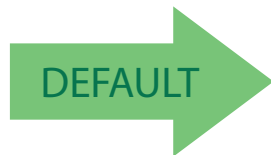

EAN-8 Minimum Read = 1



EAN-8 Minimum Read = 2



EAN-8 Minimum Read = 3



EAN-8 Minimum Read = 4

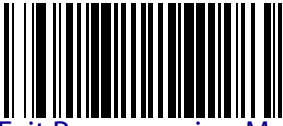

## EAN-8 Guard Insertion

This setting enables the insertion of either a missing leading or trailing guard to a scanned barcode.

To set this feature:

1. Scan the Enter/Exit Programming Mode barcode at the top of the page.
2. Scan either the enable or disable barcode below. You'll need to cover any unused barcodes on this and the facing page to ensure that the scanner reads only the barcode you intend to scan.
3. Complete the programming sequence by scanning the Enter/Exit Programming Mode barcode.

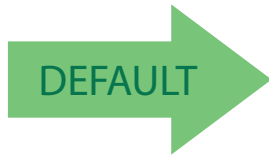

EAN-8 Guard Insertion = Disable

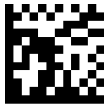

EAN-8 Guard Insertion = Enable

## EAN-8 Guard Substitution

This setting enables the scanner to substitute a guard pattern for even-parity 6 for EAN8/JAN8 labels.

To set this feature:

1. Scan the Enter/Exit Programming Mode barcode at the top of the page.
2. Scan either the enable or disable barcode below. You'll need to cover any unused barcodes on this and the facing page to ensure that the scanner reads only the barcode you intend to scan.
3. Complete the programming sequence by scanning the Enter/Exit Programming Mode barcode.

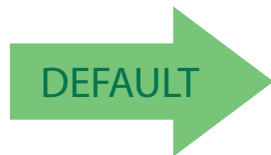

EAN-8 Guard Insertion = Disable



EAN-8 Guard Insertion = Enable

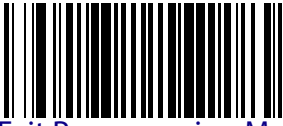

## EAN-8/Jan-8 Both Guards Substitution

Enables/disables the ability of the scanner to find an EAN/JAN8 guard pattern in cases where the EAN/JAN8 margin makes the guard look like a character.

To set this feature:

1. Scan the Enter/Exit Programming Mode barcode at the top of the page.
2. Scan either the enable or disable barcode below. You'll need to cover any unused barcodes on this and the facing page to ensure that the scanner reads only the barcode you intend to scan.
3. Complete the programming sequence by scanning the Enter/Exit Programming Mode barcode.

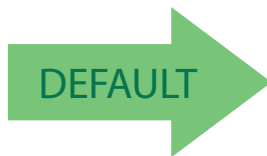

EAN-8/JAN-8 Both Guards Substitution = Disable



EAN-8/JAN-8 Both Guards Substitution = Enable



## EAN-8 Stitch Exact Label Halves

This setting enables the stitching of exact EAN-8 label halves with no overlapping characters.

To set this feature:

1. Scan the Enter/Exit Programming Mode barcode at the top of the page.
2. Scan either the enable or disable barcode below. You'll need to cover any unused barcodes on this and the facing page to ensure that the scanner reads only the barcode you intend to scan.
3. Complete the programming sequence by scanning the Enter/Exit Programming Mode barcode.

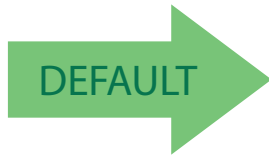

EAN-8 Stitch Exact Label Halves = Disable



EAN-8 Stitch Exact Label Halves = Enable



## EAN-8 Stitch Unlike Label Halves

This setting enables the stitching of two EAN-8 label halves together that may have different characters.

To set this feature:

1. Scan the Enter/Exit Programming Mode barcode at the top of the page.
2. Scan either the enable or disable barcode below. You'll need to cover any unused barcodes on this and the facing page to ensure that the scanner reads only the barcode you intend to scan.
3. Complete the programming sequence by scanning the Enter/Exit Programming Mode barcode.

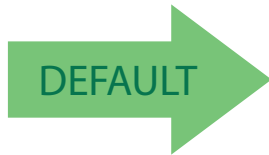

EAN-8 Stitch Unlike Label Halves = Disable



EAN-8 Stitch Unlike Label Halves = Enable

## EAN-8 Minimum Segment Length

Specifies the minimum number of characters necessary in an EAN-8/JAN-8 label segment in order for the scanner to accept a label for decoding. Selectable from 5 to 15 characters. Default setting for this feature is: 08 (8 characters).



EAN-8 Minimum Segment Length = 5 characters



EAN-8 Minimum Segment Length = 6 characters



EAN-8 Minimum Segment Length = 7 characters



EAN-8 Minimum Segment Length = 8 characters



EAN-8 Minimum Segment Length = 9 characters



EAN-8 Minimum Segment Length = 10 characters



EAN-8 Minimum Segment Length = 11 characters

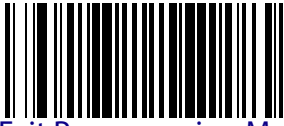

## EAN-8 Minimum Segment Length (continued)



EAN-8 Minimum Segment Length = 12 characters



EAN-8 Minimum Segment Length = 13 characters



EAN-8 Minimum Segment Length = 14 characters



EAN-8 Minimum Segment Length = 15 characters

## EAN-8 Decoding Levels

Decoding levels allow the decoder to be set to perform at one of four selectable levels:

- Very Conservative — Slower scan time, virtually eliminates misreads. The most secure setting.
- Slightly More Aggressive — Faster scanning, more aggressive, yet minimizes misreads.
- Moderately Aggressive — Even faster scanning, even more aggressive.
- Very Aggressive — Fastest scan speed, most aggressive.



Use caution when setting this feature, as more aggressive settings for this feature allow a higher potential for misreads.

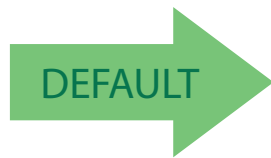

EAN-8 Decoding Level = Very Conservative



EAN-8 Decoding Level = Slightly More Aggressive



EAN-8 Decoding Level = Moderately Aggressive



EAN-8 Decoding Level = Very Aggressive

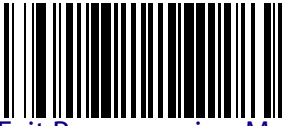

## Other UPC/EAN Options

The following pages contain other selectable features for UPC/EAN symbolologies:

- In-Store Printed Label Minimum Read on page 149
- UPC/EAN Correlation on page 150
- UPC/EAN Guard Insertion on page 151
- UPC/EAN Stitch Exact Label Halves on page 152
- UPC/EAN Stitch Unlike Label Halves on page 153
- UPC/EAN Minimum Segment Length on page 154
- Price Weight Check on page 156
- Enable EAN Two Label on page 158
- Add-ons on page 161

## In-Store Printed Label Minimum Read

This feature specifies the minimum number of consecutive In-Store Printed Label decodes before is accepted as good read.

To set this feature:

1. Scan the Enter/Exit Programming Mode barcode at the top of the page.
2. Scan your selection from the barcodes below. You'll need to cover any unused barcodes on this and the facing page to ensure that the scanner reads only the barcode you intend to scan.
3. Complete the programming sequence by scanning the ENTER/EXIT Programming Mode barcode.

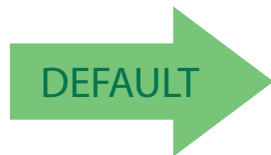

In-Store Printed Label Minimum Read = 1

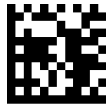

In-Store Printed Label Minimum Read = 2



In-Store Printed Label Minimum Read = 3



In-Store Printed Label Minimum Read = 4

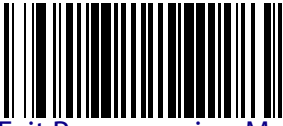

## UPC/EAN Correlation

Enables/disables character correlation for UPC/EAN.

To set this feature:

1. Scan the Enter/Exit Programming Mode barcode at the top of the page.
2. Scan either the enable or disable barcode below. You'll need to cover any unused barcodes on this and the facing page to ensure that the scanner reads only the barcode you intend to scan.
3. Complete the programming sequence by scanning the ENTER/EXIT Programming Mode barcode.

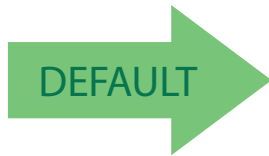

UPC/EAN Correlation = Disable



UPC/EAN Correlation = Enable



## UPC/EAN Guard Insertion

This setting enables the insertion of either a missing leading or trailing guard to a scanned barcode.

To set this feature:

1. Scan the Enter/Exit Programming Mode barcode at the top of the page.
2. Scan either the enable or disable barcode below. You'll need to cover any unused barcodes on this and the facing page to ensure that the scanner reads only the barcode you intend to scan.
3. Complete the programming sequence by scanning the Enter/Exit Programming Mode barcode.

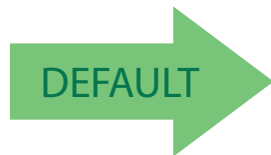

UPC/EAN Guard Insertion = Disable



UPC/EAN Guard Insertion = Enable



## UPC/EAN Stitch Exact Label Halves

This setting enables the stitching of exact UPC-A/EAN-13 label halves with no overlapping characters.

To set this feature:

1. Scan the Enter/Exit Programming Mode barcode at the top of the page.
2. Scan either the enable or disable barcode below. You'll need to cover any unused barcodes on this and the facing page to ensure that the scanner reads only the barcode you intend to scan.
3. Complete the programming sequence by scanning the Enter/Exit Programming Mode barcode.

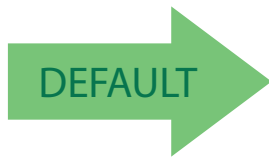

UPC/EAN Stitch Exact Label Halves = Disable



UPC/EAN Stitch Exact Label Halves = Enable

## UPC/EAN Stitch Unlike Label Halves

This setting enables the stitching of two UPC-A/EAN-13 label halves together that may have different characters.

To set this feature:

1. Scan the Enter/Exit Programming Mode barcode at the top of the page.
2. Scan either the enable or disable barcode below. You'll need to cover any unused barcodes on this and the facing page to ensure that the scanner reads only the barcode you intend to scan.
3. Complete the programming sequence by scanning the Enter/Exit Programming Mode barcode.

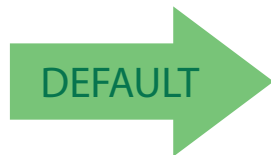

UPC/EAN Stitch Unlike Label Halves = Disable



UPC/EAN Stitch Unlike Label Halves = Enable

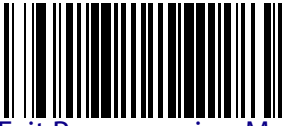

## UPC/EAN Minimum Segment Length

This feature specifies the minimum number of characters needed in a UPC/EAN segment in order to be accepted for decoding.

To set this feature:

1. Scan the Enter/Exit Programming Mode barcode at the top of the page.
2. Scan the barcode for the desired setting below. You'll need to cover any unused barcodes on this and the facing page to ensure that the scanner reads only the barcode you intend to scan.
3. Complete the programming sequence by scanning the Enter/Exit Programming Mode barcode.

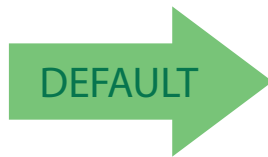

UPC/EAN Minimum Segment Length = 5 Characters



UPC/EAN Minimum Segment Length = 6 Characters



UPC/EAN Minimum Segment Length = 7 Characters



UPC/EAN Minimum Segment Length = 8 Characters



UPC/EAN Minimum Segment Length = 9 Characters

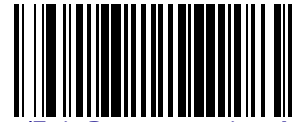

## UPC/EAN Minimum Segment Length (continued)



UPC/EAN Minimum Segment Length = 10 Characters



UPC/EAN Minimum Segment Length = 11 Characters



UPC/EAN Minimum Segment Length = 12 Characters



UPC/EAN Minimum Segment Length = 13 Characters



UPC/EAN Minimum Segment Length = 14 Characters



UPC/EAN Minimum Segment Length = 15 Characters



## Price Weight Check

Enables/disables calculation and verification of price/weight check digits. Applies to all UPC-A and EAN/JAN-13 labels with eligible<sup>1</sup> Number System/First Character digits.

Options are:

- Disable
- 4-digit price/weight
- 5-digit price/weight
- 4-digit European price/weight
- 5-digit European price/weight

To set this feature:

1. Scan the Enter/Exit Programming Mode barcode at the top of the page.
2. Scan the barcode representing the desired option below or on the following pages. You'll need to cover any unused barcodes on facing pages to ensure that the scanner reads only the barcode you intend to scan.
3. Complete the programming sequence by scanning the Enter/Exit Programming Mode barcode.



Price Weight Check = Disable



Price Weight Check = 4-digit price/weight



Price Weight Check = 5-digit price/weight

---

1. Price Weight Check generally applies to UPC-A labels with a Number System Digit of 2 and EAN/JAN-13 labels with a First Character of 2. There are a total of six flag digits corresponding to the six types. Checking applies depending upon which type is enabled.

## Price Weight Check (continued)



Price Weight Check = 4-digit European price/weight



Price Weight Check = 5-digit European price/weight

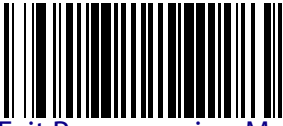

## Enable EAN Two Label

Enables/disables the ability of the scanner to decode EAN two-label pairs.  
To set this feature:

1. Scan the Enter/Exit Programming Mode barcode at the top of the page.
2. Scan either the enable or disable barcode below. You'll need to cover any unused barcodes on this and the facing page to ensure that the scanner reads only the barcode you intend to scan.
3. Complete the programming sequence by scanning the Enter/Exit Programming Mode barcode.



### NOTE

Contact Customer Support for details about advanced programming for this feature.

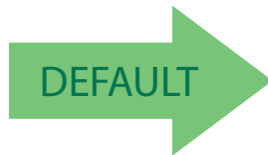

EAN Two Label = Disable



EAN Two Label = Enable



## EAN Two Label Minimum Read

This feature specifies the minimum number of consecutive EAN Two Label decodes before is accepted as good read.

To set this feature:

1. Scan the Enter/Exit Programming Mode barcode at the top of the page.
2. Scan your selection from the barcodes below. You'll need to cover any unused barcodes on this and the facing page to ensure that the scanner reads only the barcode you intend to scan.
3. Complete the programming sequence by scanning the ENTER/EXIT Programming Mode barcode.

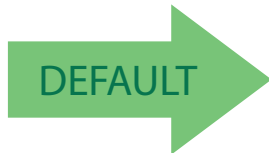

EAN Two Label Minimum Read = 1



EAN Two Label Minimum Read = 2



EAN Two Label Minimum Read = 3



EAN Two Label Minimum Read = 4

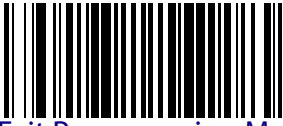

## EAN Two Label Combined Transmission

Enables/disables the transmitting of an EAN two label pair as one label.

To set this feature:

1. Scan the Enter/Exit Programming Mode barcode at the top of the page.
2. Scan either the enable or disable barcode below. You'll need to cover any unused barcodes on this and the facing page to ensure that the scanner reads only the barcode you intend to scan.
3. Complete the programming sequence by scanning the Enter/Exit Programming Mode barcode.

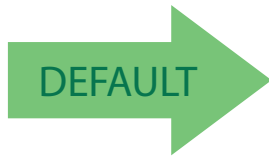

EAN Two Label Combined Transmission = Disable



EAN Two Label Combined Transmission = Enable

## Add-ons

The scanner is capable of processing different types of add-on codes, including:

- 2-Digit Supplemental
- 5-Digit Supplemental

Options are provided on the following pages for your convenience:

- Disable all add-ons — The scanner will not look for or read add-ons.
- Optional 2-Digit and 5-Digit Supplemental — Barcodes can be read which include 2-Digit or 5-Digit Supplementals, however, it is not required that add-ons be included in barcodes.



**Contact customer support for advanced programming of optional and conditional add-ons.**

### NOTE

To set this feature:

1. Scan the Enter/Exit Programming Mode barcode at the top of the page.
2. Scan the barcode representing the desired option on this and the following page. You'll need to cover any unused barcodes on facing pages to ensure that the scanner reads only the barcode you intend to scan.
3. Complete the programming sequence by scanning the Enter/Exit Programming Mode barcode.

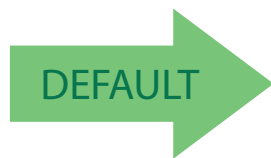

Add-ons = Disable All Add-ons



Add-ons = Optional 2-Digit and 5-Digit Supplemental



### P2 Add-on Minimum Read

This feature specifies the minimum number of times a P2 add-on must decode before it is marked valid.

To set this feature:

1. Scan the Enter/Exit Programming Mode barcode at the top of the page.
2. Scan the barcode representing the desired option on this and the following page. You'll need to cover any unused barcodes on facing pages to ensure that the scanner reads only the barcode you intend to scan.
3. Complete the programming sequence by scanning the Enter/Exit Programming Mode barcode.

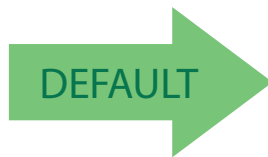

P2 Add-on Minimum Read = 2



P2 Add-on Minimum Read = 3



P2 Add-on Minimum Read = 4



P2 Add-on Minimum Read = 5



P2 Add-on Minimum Read = 6

## P2 Add-on Minimum Read (continued)



P2 Add-on Minimum Read = 7



P2 Add-on Minimum Read = 8



P2 Add-on Minimum Read = 9



P2 Add-on Minimum Read = 10



P2 Add-on Minimum Read = 11



P2 Add-on Minimum Read = 12



P2 Add-on Minimum Read = 13

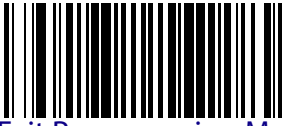

## P2 Add-on Minimum Read (continued)



P2 Add-on Minimum Read = 14



P2 Add-on Minimum Read = 15

## P5 Add-on Minimum Read

This feature specifies the minimum number of times a P5 add-on must decode before it is marked valid.

To set this feature:

1. Scan the Enter/Exit Programming Mode barcode at the top of the page.
2. Scan the barcode representing the desired option on this and the following page. You'll need to cover any unused barcodes on facing pages to ensure that the scanner reads only the barcode you intend to scan.
3. Complete the programming sequence by scanning the Enter/Exit Programming Mode barcode.



P5 Add-on Minimum Read = 1



DEFAULT



P5 Add-on Minimum Read = 2



P5 Add-on Minimum Read = 3



P5 Add-on Minimum Read = 4



P5 Add-on Minimum Read = 5



P5 Add-on Minimum Read = 6

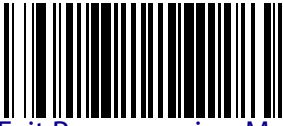

## P5 Add-on Minimum Read (continued)



P5 Add-on Minimum Read = 7



P5 Add-on Minimum Read = 8



P5 Add-on Minimum Read = 9



P5 Add-on Minimum Read = 10



P5 Add-on Minimum Read = 11



P5 Add-on Minimum Read = 12



P5 Add-on Minimum Read = 13



## P5 Add-on Minimum Read (continued)



P5 Add-on Minimum Read = 14



P5 Add-on Minimum Read = 15

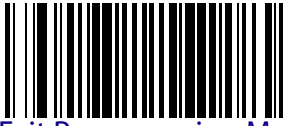

## UPC/EAN Composites

Enables/Disables Composites for the UPC/EAN families of labels.

The value is a bit field where the bits mean the following:

- A setting of 0 (zero) disables this feature.
- Bit0 – if set enabled Composites for UPCE, If clear disables Composites for UPCE
- Bit1 – if set enabled Composites for UPCA, If clear disables Composites for UPCA
- Bit2 – if set enabled Composites for EAN8, If clear disables Composites for EAN8
- Bit3 – if set enabled Composites for EAN13, If clear disables Composites for EAN13:

To set this feature:

1. Scan the Enter/Exit Programming Mode barcode at the top of the page.
2. Scan the barcode below. You'll need to cover any unused barcodes on this and the facing page to ensure that the scanner reads only the barcode you intend to scan.
3. Scan the appropriate digits from the [Alpha-Numeric Keypad on page 296](#) that represent the desired number. The selectable range is 0–15 resets. Pad all single and double digit numbers with leading zeroes to yield a two-digit entry (00–15).
4. Complete the programming sequence by scanning the Enter/Exit Programming Mode barcode.

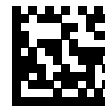

SetUPC/EAN Composites

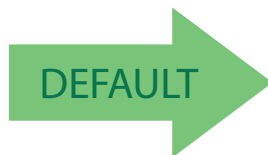

Default setting for this feature is:  
00 - Disabled

## GTIN

### GTIN Enable

Enables/Disables the ability to convert UPCE, UPCA, EAN8, and EAN13 labels into the GTIN 14-character format.



If add-on information is present on the base label prior to the conversion taking place, the add-on information will be appended to the converted GTIN barcode.

#### NOTE

To set this feature:

1. Scan the Enter/Exit Programming Mode barcode at the top of the page.
2. Scan either the enable or disable barcode below. You'll need to cover any unused barcodes on this and the facing page to ensure that the scanner reads only the barcode you intend to scan.
3. Complete the programming sequence by scanning the Enter/Exit Programming Mode barcode.

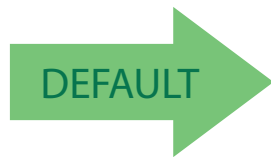

GTIN = Disable



GTIN = Enable



## GS1 DataBar

The symbology family GS1 DataBar™ was formerly known as Reduced Space Symbology (RSS). For the purpose of simplicity, GS1 DataBar variants are listed in this manual as “DataBar.”

## DataBar Omnidirectional

### DataBar Omnidirectional Enable

Enables/disables the ability of the scanner to decode DataBar Omnidirectional labels.



#### NOTE

This value-added feature is a factory-programmed option. Contact your dealer for information about upgrading your system to include this advanced capability.

To set this feature:

1. Scan the Enter/Exit Programming Mode barcode at the top of the page.
2. Scan either the enable or disable barcode below. You'll need to cover any unused barcodes on this and the facing page to ensure that the scanner reads only the barcode you intend to scan.
3. Complete the programming sequence by scanning the ENTER/EXIT Programming Mode barcode.

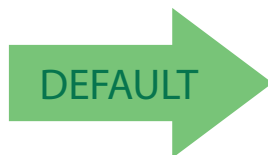

DataBar Omnidirectional = Disable



DataBar Omnidirectional = Enable

## DataBar Omnidirectional/EAN-128 Emulation

Enables/disables the ability of DataBar Omnidirectional to be transmitted as EAN-128.

1. To set this feature:
2. Scan the Enter/Exit Programming Mode barcode at the top of the page.
3. Scan either the enable or disable barcode below. You'll need to cover any unused barcodes on this and the facing page to ensure that the scanner reads only the barcode you intend to scan.
4. Complete the programming sequence by scanning the ENTER/EXIT Programming Mode barcode.

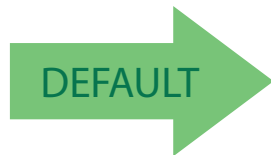

DataBar Omnidirectional/EAN-128 Emulation =  
Disable



DataBar Omnidirectional/EAN-128 Emulation = Enable

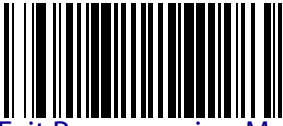

## DataBar Omnidirectional 2D Component Enable

When this feature is enabled, the software will not decode an DataBar Omnidirectional barcode with a 2D component associated with it, and the 2D component will be discarded.

To set this feature:

1. Scan the Enter/Exit Programming Mode barcode at the top of the page.
2. Scan your selection from the barcodes below. You'll need to cover any unused barcodes on this and the facing page to ensure that the scanner reads only the barcode you intend to scan.
3. Complete the programming sequence by scanning the ENTER/EXIT Programming Mode barcode.

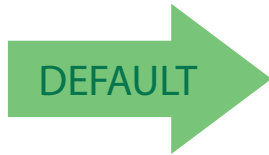

DataBar Omnidirectional 2D Component = Disable



DataBar Omnidirectional 2D Component = Enable

## DataBar Omnidirectional Minimum Read

This feature specifies the minimum number of consecutive DataBar Omnidirectional decodes before is accepted as good read.

To set this feature:

1. Scan the Enter/Exit Programming Mode barcode at the top of the page.
2. Scan your selection from the barcodes below. You'll need to cover any unused barcodes on this and the facing page to ensure that the scanner reads only the barcode you intend to scan.
3. Complete the programming sequence by scanning the ENTER/EXIT Programming Mode barcode.

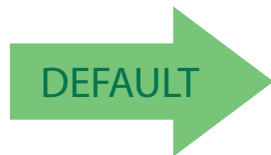

DataBar Omnidirectional Minimum Read = 1



DataBar Omnidirectional Minimum Read = 2



DataBar Omnidirectional Minimum Read = 3



DataBar Omnidirectional Minimum Read = 4

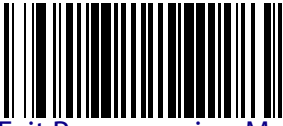

## DataBar Omnidirectional Double Read Timeout

Specifies the minimum allowable time which must pass before reading the same DataBar Omnidirectional label again (e.g. two identical items in succession).

To set this feature:

1. Scan the Enter/Exit Programming Mode barcode at the top of the page.
2. Scan your selection from the barcodes below. You'll need to cover any unused barcodes on this and the facing page to ensure that the scanner reads only the barcode you intend to scan.

Complete the programming sequence by scanning the Enter/Exit Programming Mode barcode.



DataBar Omnidirectional Double Read  
Timeout = 0.5 Seconds



DataBar Omnidirectional Double Read  
Timeout = 1 Second

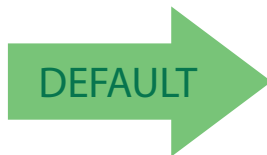

DataBar Omnidirectional Double Read  
Timeout = 2.5 Seconds



DataBar Omnidirectional Double Read  
Timeout = 3 Seconds



DataBar Omnidirectional Double Read  
Timeout = 3.5 Seconds



## DataBar Limited

### DataBar Limited Enable

Enables/disables the ability of the scanner to decode DataBar Limited labels.

To set this feature:

1. Scan the Enter/Exit Programming Mode barcode at the top of the page.
2. Scan either the enable or disable barcode below. You'll need to cover any unused barcodes on this and the facing page to ensure that the scanner reads only the barcode you intend to scan.
3. Complete the programming sequence by scanning the ENTER/EXIT Programming Mode barcode.

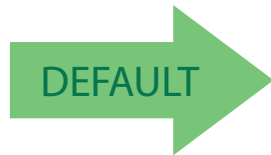

Databar Limited = Disable



Databar Limited = Enable

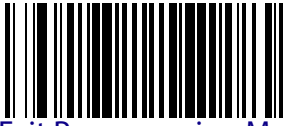

## DataBar Limited Minimum Read

This feature specifies the minimum number of consecutive Databar Limited decodes before is accepted as good read.

To set this feature:

1. Scan the Enter/Exit Programming Mode barcode at the top of the page.
2. Scan either the enable or disable barcode below. You'll need to cover any unused barcodes on this and the facing page to ensure that the scanner reads only the barcode you intend to scan.
3. Complete the programming sequence by scanning the ENTER/EXIT Programming Mode barcode.

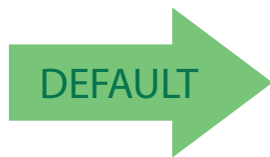

Databar Limited Minimum Read = 1



Databar Limited Minimum Read = 2



Databar Limited Minimum Read = 3



Databar Limited Minimum Read = 4

## DataBar Limited 2D Component Enable

This feature controls if a 2D label component be decoded when a Databar Limited base label is decoded.

To set this feature:

1. Scan the Enter/Exit Programming Mode barcode at the top of the page.
2. Scan either the enable or disable barcode below. You'll need to cover any unused barcodes on this and the facing page to ensure that the scanner reads only the barcode you intend to scan.
3. Complete the programming sequence by scanning the ENTER/EXIT Programming Mode barcode.

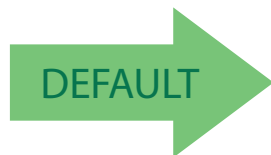

Databar Limited 2D Component = Disable



Databar Limited 2D Component = Enable

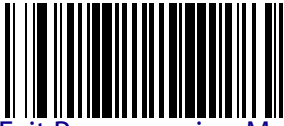

## DataBar Limited EAN128 Emulation Enable

Enables/disables GS1–EAN128 emulation for GS1 Databar Limited.

To set this feature:

1. Scan the Enter/Exit Programming Mode barcode at the top of the page.
2. Scan either the enable or disable barcode below. You'll need to cover any unused barcodes on this and the facing page to ensure that the scanner reads only the barcode you intend to scan.
3. Complete the programming sequence by scanning the ENTER/EXIT Programming Mode barcode.

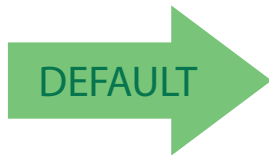

DataBar Limited EAN128 Emulation = disable



DataBar Limited EAN128 Emulation = enable

## DataBar Expanded

### DataBar Expanded Enable

Enables/disables the ability of the scanner to decode DataBar Expanded labels.



#### NOTE

This value-added feature is a factory-programmed option. Contact your dealer for information about upgrading your system to include this advanced capability.

To set this feature:

1. Scan the Enter/Exit Programming Mode barcode at the top of the page.
2. Scan either the enable or disable barcode below. You'll need to cover any unused barcodes on this and the facing page to ensure that the scanner reads only the barcode you intend to scan.
3. Complete the programming sequence by scanning the ENTER/EXIT Programming Mode barcode.

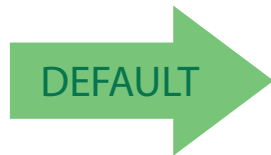

DataBar Expanded = Disable



DataBar Expanded = Enable

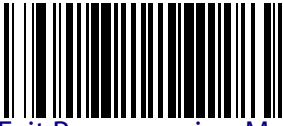

## DataBar Expanded EAN-128 Emulation

Enables/disables EAN 128 emulation for DataBar Expanded.

To set this feature:

1. Scan the Enter/Exit Programming Mode barcode at the top of the page.
2. Scan either the enable or disable barcode below. You'll need to cover any unused barcodes on this and the facing page to ensure that the scanner reads only the barcode you intend to scan.
3. Complete the programming sequence by scanning the ENTER/EXIT Programming Mode barcode.

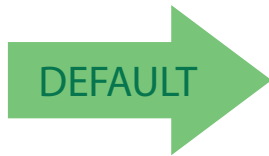

DataBar Expanded EAN-128 Emulation = Disable



DataBar Expanded EAN-128 Emulation = Enable

## DataBar Expanded 2D Component Enable

When this feature is enabled, the software will not decode an DataBar Expanded barcode with a 2D component associated with it, and the 2D component will be discarded.

To set this feature:

1. Scan the Enter/Exit Programming Mode barcode at the top of the page.
2. Scan your selection from the barcodes below. You'll need to cover any unused barcodes on this and the facing page to ensure that the scanner reads only the barcode you intend to scan.
3. Complete the programming sequence by scanning the ENTER/EXIT Programming Mode barcode.

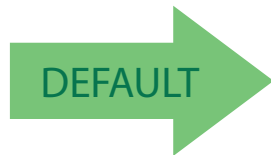

DataBar Expanded 2D Component = Disable



DataBar Expanded 2D Component = Enable

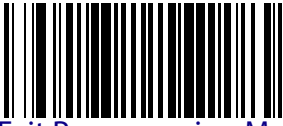

## DataBar Expanded Minimum Read

This feature specifies the minimum number of consecutive DataBar Expanded decodes before is accepted as good read.

To set this feature:

1. Scan the Enter/Exit Programming Mode barcode at the top of the page.
2. Scan your selection from the barcodes below. You'll need to cover any unused barcodes on this and the facing page to ensure that the scanner reads only the barcode you intend to scan.
3. Complete the programming sequence by scanning the ENTER/EXIT Programming Mode barcode.

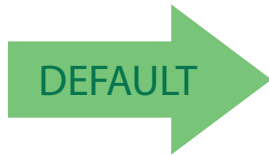

DataBar Expanded Minimum Read = 1



DataBar Expanded Minimum Read = 2



DataBar Expanded Minimum Read = 3



DataBar Expanded Minimum Read = 4



## DataBar Expanded Length Control

This feature specifies either variable-length or fixed-length decoding for DataBar Expanded.

To set this feature:

1. Scan the Enter/Exit Programming Mode barcode at the top of the page.
2. Scan your selection from the barcodes below. You'll need to cover any unused barcodes on this and the facing page to ensure that the scanner reads only the barcode you intend to scan.
3. Complete the programming sequence by scanning the ENTER/EXIT Programming Mode barcode.

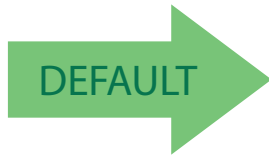

DataBar Expanded Length Control = Variable Length



DataBar Expanded Length Control = Fixed Length



## DataBar Expanded Length 1

Length 1 is the minimum label length if in variable length mode, or the first fixed length if in fixed length mode. Length includes the barcode's data characters only.

To set this feature:

1. Scan the Enter/Exit Programming Mode barcode at the top of the page.
2. Scan the barcode, [Set DataBar Expanded Length 1 on page 184](#) below. You'll need to cover any unused barcodes on this and the facing page to ensure that the scanner reads only the barcode you intend to scan.
3. Scan the appropriate digits from the [Alpha-Numeric Keypad in Appendix C](#) that represent the desired label length. The selectable range for this option is 00 to 74. Pad all single digit numbers with a leading zero to yield a two-digit entry (00-74).
4. Complete the programming sequence by scanning the ENTER/EXIT Programming Mode barcode.



Set DataBar Expanded Length 1

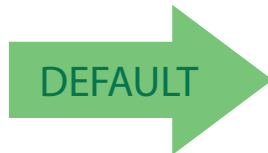

Default setting for this feature = 01

## DataBar Expanded Length 2

Length 2 is the maximum label length if in variable length mode, or the second fixed length if in fixed length mode. Length includes the barcode's data characters only.



**When in Fixed Length mode, if Length 2 is set to the value of 00 (zero), then only Length 1 will apply.**

### NOTE

To set this feature:

1. Scan the Enter/Exit Programming Mode barcode at the top of the page.
2. Scan the barcode, [Set DataBar Expanded Length 2 on page 185](#) below. You'll need to cover any unused barcodes on this and the facing page to ensure that the scanner reads only the barcode you intend to scan.
3. Scan the appropriate digits from the [Alpha-Numeric Keypad in Appendix C](#) that represent the desired label length. The selectable range for this option is 00 to 74. Pad all single digit numbers with a leading zero to yield a two-digit entry (00-74).
4. Complete the programming sequence by scanning the ENTER/EXIT Programming Mode barcode.



Set DataBar Expanded Length 2

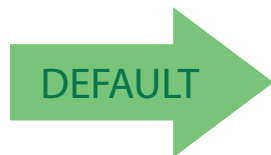

Default setting for this feature = 4A (length = 74)

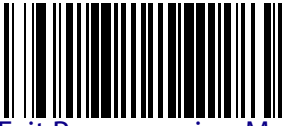

## DataBar Expanded Reverse Retry

Enables/disables the reading of out of specification labels where the last row has been printed in reverse.

- When enabled, DataBar Expanded Stacked labels that have the last row incorrectly printed in reverse will be re-decoded.
- When disabled, DataBar Expanded Stacked labels that have the last row incorrectly printed in reverse will not be read.

To set this feature:

1. Scan the Enter/Exit Programming Mode barcode at the top of the page.
2. Scan your selection from the barcodes below. You'll need to cover any unused barcodes on this and the facing page to ensure that the scanner reads only the barcode you intend to scan.
3. Complete the programming sequence by scanning the ENTER/EXIT Programming Mode barcode.

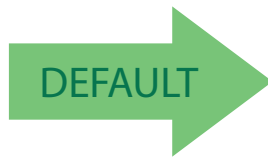

DataBar Expanded Reverse Retry = Disable



DataBar Expanded Reverse Retry = Enable

## Code 39

### Code 39 Enable

Enables/disables the ability of the scanner to decode Code 39 labels.

To set this feature:

1. Scan the Enter/Exit Programming Mode barcode at the top of the page.
2. Scan either the enable or disable barcode below. You'll need to cover any unused barcodes on this and the facing page to ensure that the scanner reads only the barcode you intend to scan.
3. Complete the programming sequence by scanning the ENTER/EXIT Programming Mode barcode.



Code 39 = Disable



Code 39 = Enable



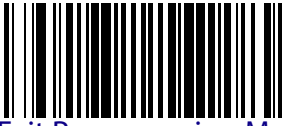

## Code 39 Start Stop Character Transmission

Enables/disables transmission of Code 39 start and stop characters.



This item is ignored when the advanced feature, Full Label Edit, is enabled

### NOTE

To set this feature:

1. Scan the Enter/Exit Programming Mode barcode at the top of the page.
2. Scan either the enable or disable barcode below. You'll need to cover any unused barcodes on this and the facing page to ensure that the scanner reads only the barcode you intend to scan.
3. Complete the programming sequence by scanning the ENTER/EXIT Programming Mode barcode.

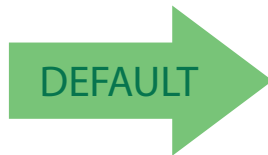

Code 39 Start Stop Character Transmission = Disable



Code 39 Start Stop Character Transmission = Enable

## Code 39 Check Character Calculation

Enables/disables calculation and verification of an optional Code 39 check character. When disabled, any check character in label is treated as a data character.



### NOTE

If check calculation is disabled, the risk is increased that a mis-read can occur.

To set this feature:

1. Scan the Enter/Exit Programming Mode barcode at the top of the page.
2. Scan either the enable or disable barcode below. You'll need to cover any unused barcodes on this and the facing page to ensure that the scanner reads only the barcode you intend to scan.
3. Complete the programming sequence by scanning the ENTER/EXIT Programming Mode barcode.

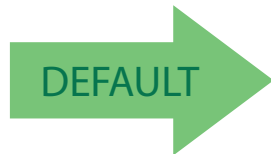

Code 39 Check Character Calculation = Disable



Code 39 Check Character Calculation = Enable



## Code 39 Check Character Transmission

Enables/disables transmission of optional Code 39 check character.



This item is ignored when the advanced feature, Full Label Edit, is enabled.

### NOTE

To set this feature:

1. Scan the Enter/Exit Programming Mode barcode at the top of the page.
2. Scan either the enable or disable barcode below. You'll need to cover any unused barcodes on this and the facing page to ensure that the scanner reads only the barcode you intend to scan.
3. Complete the programming sequence by scanning the ENTER/EXIT Programming Mode barcode.



Code 39 Check Character Transmission = Disable



Code 39 Check Character Transmission = Enable





## Code 39 Full ASCII

Enables/disables the ability of the scanner to translate to Code 39 full ASCII labels.

To set this feature:

1. Scan the Enter/Exit Programming Mode barcode at the top of the page.
2. Scan either the enable or disable barcode below. You'll need to cover any unused barcodes on this and the facing page to ensure that the scanner reads only the barcode you intend to scan.
3. Complete the programming sequence by scanning the ENTER/EXIT Programming Mode barcode.

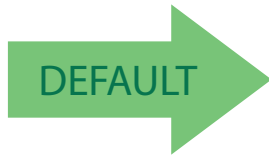

Code 39 Full ASCII = Disable



Code 39 Full ASCII = Enable



## Code 39 Minimum Read

This feature specifies the minimum number of consecutive Code 39 decodes before is accepted as good read.

To set this feature:

1. Scan the Enter/Exit Programming Mode barcode at the top of the page.
2. Scan your selection from the barcodes below. You'll need to cover any unused barcodes on this and the facing page to ensure that the scanner reads only the barcode you intend to scan.
3. Complete the programming sequence by scanning the ENTER/EXIT Programming Mode barcode.

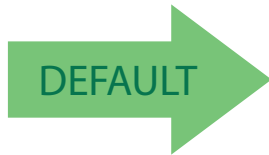

Code 39 Minimum Read = 1



Code 39 Minimum Read = 2



Code 39 Minimum Read = 3



Code 39 Minimum Read = 4

## Code 39 Length Control

This feature specifies whether variable-length or fixed-length decoding will be set for Code 39.

To set this feature:

1. Scan the Enter/Exit Programming Mode barcode at the top of the page.
2. Scan your selection from the barcodes below. You'll need to cover any unused barcodes on this and the facing page to ensure that the scanner reads only the barcode you intend to scan.
3. Complete the programming sequence by scanning the ENTER/EXIT Programming Mode barcode.

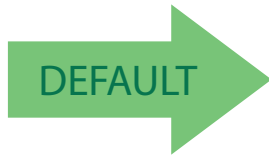

Code 39 Length Control = Variable Length



Code 39 Length Control = Fixed Length



## Code 39 Length 1

If Code 39 Length Control is set to Fixed–Length decoding, this feature specifies Code 39 first fixed length. If Code 39 Length Control is set to Variable–Length decoding, this feature specifies the minimum label length.

To set this feature:

1. Scan the Enter/Exit Programming Mode barcode at the top of the page.
2. Scan the barcode, [Set Code 39 Length 1 on page 194](#) below. You’ll need to cover any unused barcodes on this and the facing page to ensure that the scanner reads only the barcode you intend to scan.
3. Scan the appropriate digits from the [Alpha–Numeric Keypad in Appendix C](#) that represent the desired label length. The selectable range for this option is 00 to 50. Pad all single digit numbers with a leading zero to yield a two–digit entry (00–50).
4. Complete the programming sequence by scanning the ENTER/EXIT Programming Mode barcode.



Set Code 39 Length 1

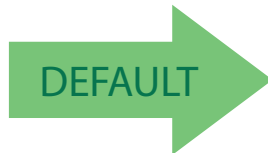

Default setting for this feature = 02

## Code 39 Length 2

If Code 39 Length Control is set to Fixed–Length decoding, this feature specifies Code 39 second fixed length. If Code 39 Length Control is set to Variable–Length decoding, this feature specifies the maximum label length.



**When in Fixed Length mode, if Length 2 is set to the value of 00, then only Length 1 will apply**

### NOTE

To set this feature:

1. Scan the Enter/Exit Programming Mode barcode at the top of the page.
2. Scan the barcode, [Set Code 39 Length 2 on page 195](#) below. You'll need to cover any unused barcodes on this and the facing page to ensure that the scanner reads only the barcode you intend to scan.
3. Scan the appropriate digits from the [Alpha–Numeric Keypad in Appendix C](#) that represent the desired label length. The selectable range for this option is 00, no second fixed length, or 01 to 50. Pad all single digit numbers with a leading zero to yield a two–digit entry (00–50).
4. Complete the programming sequence by scanning the ENTER/EXIT Programming Mode barcode.



Set Code 39 Length 2

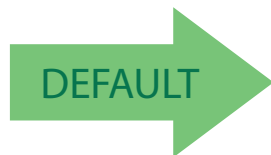

Default setting for this feature = 32 (length = 50)

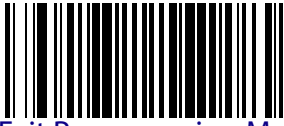

## Code 39 Stitching

Enables/disables stitching for Code 39 labels. When parts of a Code 39 barcode are presented to the scanner with this feature enabled, the barcode parts will be assembled by the scanner’s software, and the data will be decoded if all barcode proofing requirements are met.

To set this feature:

1. Scan the Enter/Exit Programming Mode barcode at the top of the page.
2. Scan your selection from the barcodes below. You’ll need to cover any unused barcodes on this and the facing page to ensure that the scanner reads only the barcode you intend to scan.
3. Complete the programming sequence by scanning the ENTER/EXIT Programming Mode barcode.



Code 39 Stitching = Disable



Code 39 Stitching = Enable



## Code 39 Require Margins

Enables/disables the requirement that quiet zones be present in a Code 39 barcode.

To set this feature:

1. Scan the Enter/Exit Programming Mode barcode at the top of the page.
2. Scan either the enable or disable barcode below. You'll need to cover any unused barcodes on this and the facing page to ensure that the scanner reads only the barcode you intend to scan.
3. Complete the programming sequence by scanning the ENTER/EXIT Programming Mode barcode.

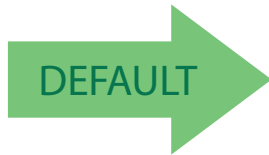

Code 39 Require Margins = Quiet Zones Not Required



Code 39 Require Margins = Quiet Zones Required

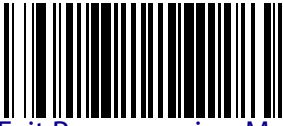

## Code 32 Italian Pharmacode

### Code 32 Italian Pharmacode Enable

Enables/disables the ability of the scanner to decode Italian Pharmaceutical Code 39 labels.

To set this feature:

1. Scan the Enter/Exit Programming Mode barcode at the top of the page.
2. Scan either the enable or disable barcode below. You'll need to cover any unused barcodes on this and the facing page to ensure that the scanner reads only the barcode you intend to scan.
3. Complete the programming sequence by scanning the ENTER/EXIT Programming Mode barcode.

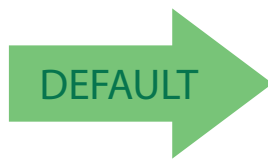

Code 32 Italian Pharmacode Enable = Disable



Code 32 Italian Pharmacode Enable = Enable



## Code 32 Start Stop Character Transmission

Enables/ disables transmission of start and stop characters for Code 32.



This item is ignored when the advanced feature, Full Label Edit, is enabled.

### NOTE

To set this feature:

1. Scan the Enter/Exit Programming Mode barcode at the top of the page.
2. Scan either the enable or disable barcode below. You'll need to cover any unused barcodes on this and the facing page to ensure that the scanner reads only the barcode you intend to scan.
3. Complete the programming sequence by scanning the ENTER/EXIT Programming Mode barcode.

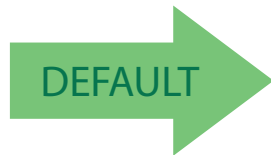

Code 32 Start Stop Character Transmission = Disable



Code 32 Start Stop Character Transmission = Enable

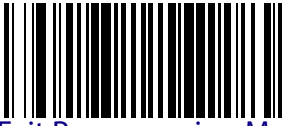

## Code 32 Check Character Transmission

Enables/disables transmission of Code 32 check character.



This item is ignored when the advanced feature, Full Label Edit, is enabled.

### NOTE

To set this feature:

1. Scan the Enter/Exit Programming Mode barcode at the top of the page.
2. Scan either the enable or disable barcode below. You'll need to cover any unused barcodes on this and the facing page to ensure that the scanner reads only the barcode you intend to scan.
3. Complete the programming sequence by scanning the ENTER/EXIT Programming Mode barcode.

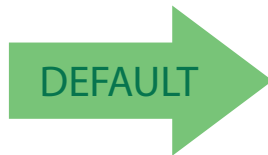

Code 32 Check Character Transmission = Disable



Code 32 Check Character Transmission = Enable

## Code 128

### Code 128 Enable

Enables/disables the ability of the scanner to decode Code 128 labels.

To set this feature:

1. Scan the Enter/Exit Programming Mode barcode at the top of the page.
2. Scan either the enable or disable barcode below. You'll need to cover any unused barcodes on this and the facing page to ensure that the scanner reads only the barcode you intend to scan.
3. Complete the programming sequence by scanning the ENTER/EXIT Programming Mode barcode.



Code 128 = Disable



Code 128 = Enable





## Code 128 Transmit Function Characters

Enables/disables transmission of Code 128 function characters 1, 2, 3, and 4.



**Disabled is the recommended setting for all interfaces.**

### NOTE

To set this feature:

1. Scan the Enter/Exit Programming Mode barcode at the top of the page.
2. Scan either the enable or disable barcode below. You'll need to cover any unused barcodes on this and the facing page to ensure that the scanner reads only the barcode you intend to scan.
3. Complete the programming sequence by scanning the ENTER/EXIT Programming Mode barcode.

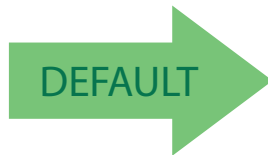

Code 128 Transmit Function Characters = Disable



Code 128 Transmit Function Characters = Enable

## Expand Code128 to Code 39

Enables/disables expansion of Code 128 labels to Code 39.

To set this feature:

1. Scan the Enter/Exit Programming Mode barcode at the top of the page.
2. Scan either the enable or disable barcode below. You'll need to cover any unused barcodes on this and the facing page to ensure that the scanner reads only the barcode you intend to scan.
3. Complete the programming sequence by scanning the ENTER/EXIT Programming Mode barcode.

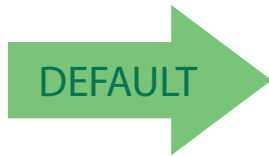

Expand Code128 to Code 39 = Disable

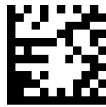

Expand Code128 to Code 39 = Enable

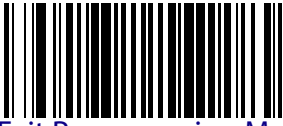

## Code 128 Minimum Read

This feature specifies the minimum number of consecutive Code 128 decodes before is accepted as good read.

To set this feature:

1. Scan the Enter/Exit Programming Mode barcode at the top of the page.
2. Scan your selection from the barcodes below. You'll need to cover any unused barcodes on this and the facing page to ensure that the scanner reads only the barcode you intend to scan.
3. Complete the programming sequence by scanning the ENTER/EXIT Programming Mode barcode.

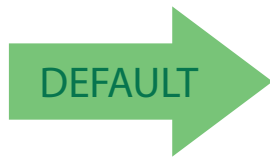

Code 128 Minimum Read = 1



Code 128 Minimum Read = 2



Code 128 Minimum Read = 3



Code 128 Minimum Read = 4

## Code 128 Length Control

This feature specifies whether variable-length or fixed-length decoding will be set for Code 128.

To set this feature:

1. Scan the Enter/Exit Programming Mode barcode at the top of the page.
2. Scan your selection from the barcodes below. You'll need to cover any unused barcodes on this and the facing page to ensure that the scanner reads only the barcode you intend to scan.
3. Complete the programming sequence by scanning the ENTER/EXIT Programming Mode barcode.

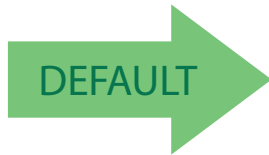

Code 128 Length Control = Variable Length



Code 128 Length Control = Fixed Length

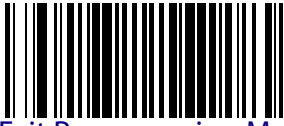

## Code 128 Length 1

If Code 128 Length Control is set to Fixed–Length decoding, this feature specifies Code 128 first fixed length. If Code 128 Length Control is set to Variable–Length decoding, this feature specifies the minimum label length.

To set this feature:

1. Scan the Enter/Exit Programming Mode barcode at the top of the page.
2. Scan the barcode, [Set Code 128 Length 1 on page 206](#) below. You’ll need to cover any unused barcodes on this and the facing page to ensure that the scanner reads only the barcode you intend to scan.
3. Scan the appropriate digits from the [Alpha–Numeric Keypad in Appendix C](#) that represent the desired label length. The selectable range for this option is 01 to 80. Pad all single digit numbers with a leading zero to yield a two–digit entry (01–80).
4. Complete the programming sequence by scanning the ENTER/EXIT Programming Mode barcode.



Set Code 128 Length 1

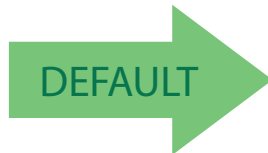

Default setting for this feature = 01



## Code 128 Length 2

If Code 128 Length Control is set to Fixed–Length decoding, this feature specifies Code 128 second fixed length. If Code 128 Length Control is set to Variable–Length decoding, this feature specifies the maximum label length.



**When in Fixed Length mode, if Length 2 is set to the value of 00 (zero), then only Length 1 will apply.**

### NOTE

To set this feature:

1. Scan the Enter/Exit Programming Mode barcode at the top of the page.
2. Scan the barcode, [Set Code 128 Length 2 on page 207](#) below. You'll need to cover any unused barcodes on this and the facing page to ensure that the scanner reads only the barcode you intend to scan.
3. Scan the appropriate digits from the [Alpha–Numeric Keypad in Appendix C](#) that represent the desired label length. The selectable range for this option is 01 to 80. Pad all single digit numbers with a leading zero to yield a two–digit entry (01–80).
4. Complete the programming sequence by scanning the ENTER/EXIT Programming Mode barcode.



Set Code 128 Length 2

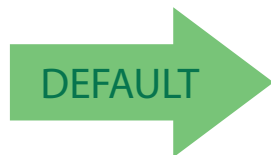

Default setting for this feature = 50 (length = 80)



## Code 128 Stitching

Enables/disables stitching for Code 128 labels. When parts of a Code 128 barcode are presented to the scanner with this feature enabled, the barcode parts will be assembled by the scanner's software, and the data will be decoded if all barcode proofing requirements are met.

To set this feature:

1. Scan the Enter/Exit Programming Mode barcode at the top of the page.
2. Scan your selection from the barcodes below. You'll need to cover any unused barcodes on this and the facing page to ensure that the scanner reads only the barcode you intend to scan.
3. Complete the programming sequence by scanning the ENTER/EXIT Programming Mode barcode.



Code 128 Stitching = Disable



Code 128 Stitching = Enable



## EAN-128

### EAN-128 Enable

Enables/disables the ability of the scanner to translate EAN128 labels to the EAN128 data format.

To set this feature:

1. Scan the Enter/Exit Programming Mode barcode at the top of the page.
2. Scan either the enable or disable barcode below. You'll need to cover any unused barcodes on this and the facing page to ensure that the scanner reads only the barcode you intend to scan.
3. Complete the programming sequence by scanning the ENTER/EXIT Programming Mode barcode.

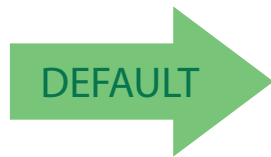

EAN-128 = Transmit EAN128 labels in Code128 data format



EAN-128 = Transmit EAN128 labels in EAN128 data format

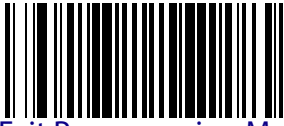

## Interleaved 2 of 5 (I 2 OF 5)

### Interleaved 2 of 5 (I 2 OF 5) Enable

Enables/disables the ability of the scanner to decode Interleaved 2 of 5 labels.  
To set this feature:

1. Scan the Enter/Exit Programming Mode barcode at the top of the page.
2. Scan either the enable or disable barcode below. You'll need to cover any unused barcodes on this and the facing page to ensure that the scanner reads only the barcode you intend to scan.
3. Complete the programming sequence by scanning the ENTER/EXIT Programming Mode barcode.

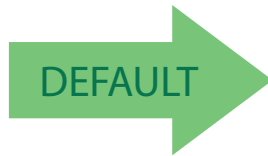

I 2 of 5 = Disable



I 2 of 5 = Enable

## I 2 of 5 Check Character Calculation

Enables/disables calculation and verification of an optional Interleaved 2 of 5 check character.



### NOTE

If check character calculation is disabled, the risk is increased that a misread can occur. When disabled, any check characters in a barcode are treated as data characters.

1. To set this feature:
2. Scan the Enter/Exit Programming Mode barcode at the top of the page.
3. Scan either the enable or disable barcode below. You'll need to cover any unused barcodes on this and the facing page to ensure that the scanner reads only the barcode you intend to scan.
4. Complete the programming sequence by scanning the ENTER/EXIT Programming Mode barcode.

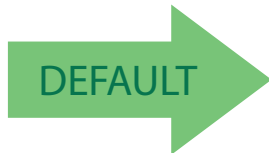

I 2 of 5 Check Character Calculation = Disable

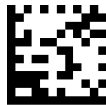

I 2 of 5 Check Character Calculation = Enable



## I 2 of 5 Check Character Transmission

Enables/disables transmission of an optional Interleaved 2 of 5 check character.



**NOTE**

This feature applies only when I 2 of 5 Check Character Calculation is enabled. This item is ignored when the advanced feature, Full Label Edit, is enabled.

To set this feature:

1. Scan the Enter/Exit Programming Mode barcode at the top of the page.
2. Scan either the enable or disable barcode below. You'll need to cover any unused barcodes on this and the facing page to ensure that the scanner reads only the barcode you intend to scan.
3. Complete the programming sequence by scanning the ENTER/EXIT Programming Mode barcode.



I 2 of 5 Check Character Transmission = Disable



I 2 of 5 Check Character Transmission = Enable



## I 2 of 5 Minimum Read

This feature specifies the minimum number of consecutive I 2 of 5 decodes before is accepted as good read.

To set this feature:

1. Scan the Enter/Exit Programming Mode barcode at the top of the page.
2. Scan your selection from the barcodes below. You'll need to cover any unused barcodes on this and the facing page to ensure that the scanner reads only the barcode you intend to scan.
3. Complete the programming sequence by scanning the ENTER/EXIT Programming Mode barcode.

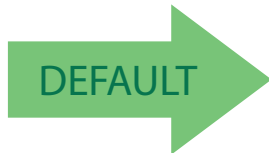

I 2 of 5 Minimum Read = 1



I 2 of 5 Minimum Read = 2



I 2 of 5 Minimum Read = 3



I 2 of 5 Minimum Read = 4

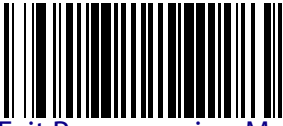

## I 2 of 5 Length Control

This feature specifies whether variable-length or fixed-length decoding will be set for I 2 of 5.

To set this feature:

1. Scan the Enter/Exit Programming Mode barcode at the top of the page.
2. Scan your selection from the barcodes below. You'll need to cover any unused barcodes on this and the facing page to ensure that the scanner reads only the barcode you intend to scan.
3. Complete the programming sequence by scanning the ENTER/EXIT Programming Mode barcode.

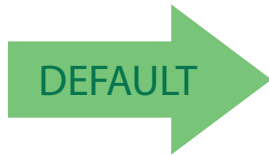

I 2 of 5 Length Control = Variable Length



I 2 of 5 Length Control = Fixed Length



## I 2 of 5 Length 1

If I 2 of 5 Length Control is set to Fixed-Length decoding, this feature specifies I 2 of 5 first fixed length. If I 2 of 5 Length Control is set to Variable-Length decoding, this feature specifies the minimum label length.

To set this feature:

1. Scan the Enter/Exit Programming Mode barcode at the top of the page.
2. Scan the barcode, [Set I 2 of 5 Length 1 on page 215](#) below. You'll need to cover any unused barcodes on this and the facing page to ensure that the scanner reads only the barcode you intend to scan.
3. Scan the appropriate digits from the [Alpha-Numeric Keypad in Appendix C](#) that represent the desired label length. The selectable range for this option is 02 to 50, even numbers only. Pad all single digit numbers with a leading zero to yield a two-digit entry (02–50).
4. Complete the programming sequence by scanning the ENTER/EXIT Programming Mode barcode.



Set I 2 of 5 Length 1

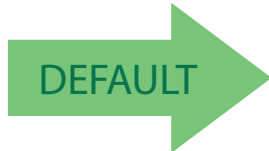

Default setting for this feature = 06



## I 2 of 5 Length 2

If I 2 of 5 Length Control is set to Fixed–Length decoding, this feature specifies I 2 of 5 second fixed length. If I 2 of 5 Length Control is set to Variable–Length decoding, this feature specifies the maximum label length.



**When in Fixed Length mode, if Length 2 is set to the value of 00 (zero), then only Length 1 will apply.**

**NOTE**

To set this feature:

1. Scan the Enter/Exit Programming Mode barcode at the top of the page.
2. Scan the barcode, [Set I 2 of 5 Length 2 on page 216](#) below. You'll need to cover any unused barcodes on this and the facing page to ensure that the scanner reads only the barcode you intend to scan.
3. Scan the appropriate digits from the [Alpha–Numeric Keypad in Appendix C](#) that represent the desired label length. The selectable range for this option is 00, or 02 to 50; even numbers only. Pad all single digit numbers with a leading zero to yield a two–digit entry (02–50).
4. Complete the programming sequence by scanning the ENTER/EXIT Programming Mode barcode.



Set I 2 of 5 Length 2

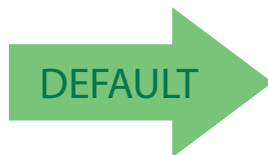

Default setting for this feature = 32 (length = 50)

## Codabar

### Codabar Enable

Enables/disables the ability of the scanner to decode Codabar labels.

To set this feature:

1. Scan the Enter/Exit Programming Mode barcode at the top of the page.
2. Scan either the enable or disable barcode below. You'll need to cover any unused barcodes on this and the facing page to ensure that the scanner reads only the barcode you intend to scan.
3. Complete the programming sequence by scanning the ENTER/EXIT Programming Mode barcode.

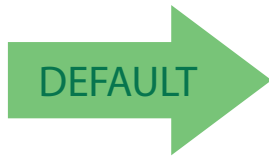

Codabar = Disable



Codabar = Enable



## Codabar Start Stop Character Transmission

Enables/disables transmission of Codabar start and stop characters.



This item is ignored when the advanced feature, Full Label Edit, is enabled.

### NOTE

To set this feature:

1. Scan the Enter/Exit Programming Mode barcode at the top of the page.
2. Scan either the enable or disable barcode below. You'll need to cover any unused barcodes on this and the facing page to ensure that the scanner reads only the barcode you intend to scan.
3. Complete the programming sequence by scanning the ENTER/EXIT Programming Mode barcode.



Codabar Start Stop Character Transmission = Disable



Codabar Start Stop Character Transmission = Enable



## Codabar Start Stop Character Set

This feature specifies the format of transmitted Codabar start/stop characters.

Options are:

- ABCD/TN\* E
- ABCD/ABCD
- abcd/tn\* e
- abcd/abcd

To set this feature:

1. Scan the Enter/Exit Programming Mode barcode at the top of the page.
2. Scan the barcode below or from the following page representing the desired option. You'll need to cover any unused barcodes and facing pages to ensure that the scanner reads only the barcode you intend to scan.
3. Complete the programming sequence by scanning the ENTER/EXIT Programming Mode barcode.



Codabar Start Stop Character Set = ABCD/TN\* E



Codabar Start Stop Character Set = ABCD/ABCD



Codabar Start Stop Character Set = abcd/tn\* e



Codabar Start Stop Character Set = abcd/abcd



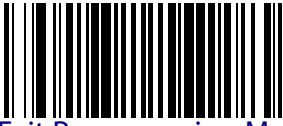

## Codabar Start Stop Character Match

Enables/disables the requirement that Codabar start and stop characters match.

To set this feature:

1. Scan the Enter/Exit Programming Mode barcode at the top of the page.
2. Scan either the enable or disable barcode below. You'll need to cover any unused barcodes on this and the facing page to ensure that the scanner reads only the barcode you intend to scan.
3. Complete the programming sequence by scanning the ENTER/EXIT Programming Mode barcode.

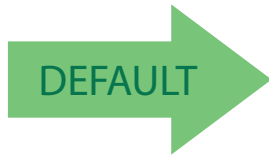

Codabar Start Stop Character Match = Disable



Codabar Start Stop Character Match = Enable

## Codabar Check Character Calculation

Enables/disables calculation and verification of an optional Codabar check character.



### NOTE

If check character calculation is disabled, the risk is increased that a misread can occur. When disabled, any check characters in a barcode are treated as data characters.

To set this feature:

1. Scan the Enter/Exit Programming Mode barcode at the top of the page.
2. Scan either the enable or disable barcode below. You'll need to cover any unused barcodes on this and the facing page to ensure that the scanner reads only the barcode you intend to scan.
3. Complete the programming sequence by scanning the ENTER/EXIT Programming Mode barcode.

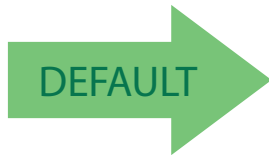

Codabar Check Character Calculation = Disable



Codabar Check Character Calculation = Enable

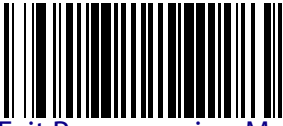

## Codabar Check Character Transmission

Enables/disables transmission of an optional Codabar check character.



### NOTE

Applies only when Codabar Check Character Calculation is enabled. This item is ignored when the advanced feature, Full Label Edit, is enabled.

To set this feature:

1. Scan the Enter/Exit Programming Mode barcode at the top of the page.
2. Scan either the enable or disable barcode below. You'll need to cover any unused barcodes on this and the facing page to ensure that the scanner reads only the barcode you intend to scan.
3. Complete the programming sequence by scanning the ENTER/EXIT Programming Mode barcode.



Codabar Check Character Transmission = Disable



Codabar Check Character Transmission = Enable





## Codabar Minimum Read

This feature specifies the minimum number of consecutive Codabar decodes before is accepted as good read.

To set this feature:

1. Scan the Enter/Exit Programming Mode barcode at the top of the page.
2. Scan your selection from the barcodes below. You'll need to cover any unused barcodes on this and the facing page to ensure that the scanner reads only the barcode you intend to scan.
3. Complete the programming sequence by scanning the ENTER/EXIT Programming Mode barcode.

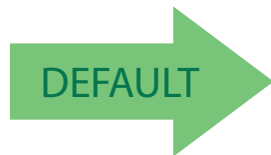

Codabar Minimum Read = 1



Codabar Minimum Read = 2



Codabar Minimum Read = 3



Codabar Minimum Read = 4



## Codabar Length Control

This feature specifies whether variable-length or fixed-length decoding will be set for Codabar.

To set this feature:

1. Scan the Enter/Exit Programming Mode barcode at the top of the page.
2. Scan your selection from the barcodes below. You'll need to cover any unused barcodes on this and the facing page to ensure that the scanner reads only the barcode you intend to scan.
3. Complete the programming sequence by scanning the ENTER/EXIT Programming Mode barcode.

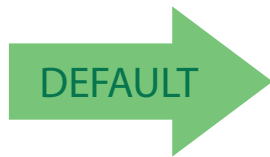

Codabar Length Control = Variable Length



Codabar Length Control = Fixed Length

## Codabar Length 1

If Codabar Length Control is set to Fixed–Length decoding, this feature specifies Codabar first fixed length. If Codabar Length Control is set to Variable–Length decoding, this feature specifies the minimum label length.

To set this feature:

1. Scan the Enter/Exit Programming Mode barcode at the top of the page.
2. Scan the barcode, [Set Codabar Length 1 on page 225](#) below. You'll need to cover any unused barcodes on this and the facing page to ensure that the scanner reads only the barcode you intend to scan.
3. Scan the appropriate digits from the [Alpha–Numeric Keypad in Appendix C](#) that represent the desired label length. The selectable range for this option is 03 to 50. Pad all single digit numbers with a leading zero to yield a two–digit entry (03–50).
4. Complete the programming sequence by scanning the ENTER/EXIT Programming Mode barcode.



Set Codabar Length 1

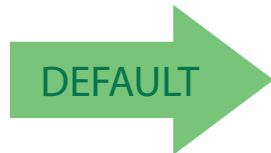

Default setting for this feature = 03



## Codabar Length 2

If Codabar Length Control is set to Fixed–Length decoding, this feature specifies Codabar second fixed length. If Codabar Length Control is set to Variable–Length decoding, this feature specifies the maximum label length.



**When in Fixed Length mode, if Length 2 is set to the value of 00 (zero), then only Length 1 will apply.**

### NOTE

To set this feature:

1. Scan the Enter/Exit Programming Mode barcode at the top of the page.
2. Scan the barcode, [Set Codabar Length 2 on page 226](#) below. You’ll need to cover any unused barcodes on this and the facing page to ensure that the scanner reads only the barcode you intend to scan.
3. Scan the appropriate digits from the [Alpha–Numeric Keypad in Appendix C](#) that represent the desired label length. The selectable range for this option is 00 (meaning ignore this length), or 03 to 50. Pad all single digit numbers with a leading zero to yield a two–digit entry (03–50).
4. Complete the programming sequence by scanning the ENTER/EXIT Programming Mode barcode.



Set Codabar Length 2

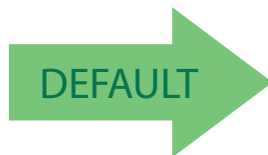

Default setting for this feature = 32 (length = 50)

## Codabar Require Margins

Enables/disables the requirement that quiet zones be present in a Codabar barcode.

To set this feature:

1. Scan the Enter/Exit Programming Mode barcode at the top of the page.
2. Scan either the enable or disable barcode below. You'll need to cover any unused barcodes on this and the facing page to ensure that the scanner reads only the barcode you intend to scan.
3. Complete the programming sequence by scanning the ENTER/EXIT Programming Mode barcode.

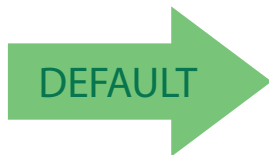

Codabar Require Margins = Quiet Zones Not Required



Codabar Require Margins = Quiet Zones Required

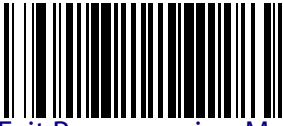

## Code 93

### Code 93 Enable

Enables/disables the ability of the scanner to decode Code 93 labels.

To set this feature:

1. Scan the Enter/Exit Programming Mode barcode at the top of the page.
2. Scan either the enable or disable barcode below. You'll need to cover any unused barcodes on this and the facing page to ensure that the scanner reads only the barcode you intend to scan.
3. Complete the programming sequence by scanning the ENTER/EXIT Programming Mode barcode.

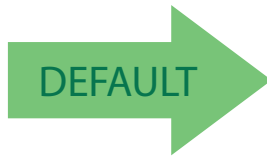

Code 93 = Disable



Code 93 = Enable

## Code 93 Minimum Read

This feature specifies the minimum number of consecutive Code 93 decodes before is accepted as good read.

To set this feature:

1. Scan the Enter/Exit Programming Mode barcode at the top of the page.
2. Scan your selection from the barcodes below. You'll need to cover any unused barcodes on this and the facing page to ensure that the scanner reads only the barcode you intend to scan.
3. Complete the programming sequence by scanning the ENTER/EXIT Programming Mode barcode.

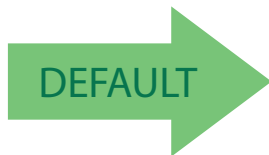

Code 93 Minimum Read = 1



Code 93 Minimum Read = 2



Code 93 Minimum Read = 3



Code 93 Minimum Read = 4

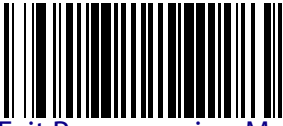

## Code 93 Length Control

This feature specifies whether variable-length or fixed-length decoding will be set for Code 93.

To set this feature:

1. Scan the Enter/Exit Programming Mode barcode at the top of the page.
2. Scan your selection from the barcodes below. You'll need to cover any unused barcodes on this and the facing page to ensure that the scanner reads only the barcode you intend to scan.
3. Complete the programming sequence by scanning the ENTER/EXIT Programming Mode barcode.

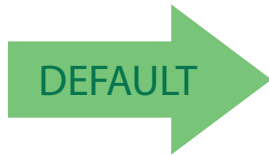

Code 93 Length Control = Variable Length

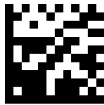

Code 93 Length Control = Fixed Length



## Code 93 Length 1

If Code 93 Length Control is set to Fixed–Length decoding, this feature specifies Code 93 first fixed length. If Code 93 Length Control is set to Variable–Length decoding, this feature specifies the minimum label length.

To set this feature:

1. Scan the Enter/Exit Programming Mode barcode at the top of the page.
2. Scan the barcode, [Set Code 93 Length 1 on page 231](#) below. You'll need to cover any unused barcodes on this and the facing page to ensure that the scanner reads only the barcode you intend to scan.
3. Scan the appropriate digits from the [Alpha–Numeric Keypad in Appendix C](#) that represent the desired label length. The selectable range for this option is 01 to 50. Pad all single digit numbers with a leading zero to yield a two–digit entry (01–50).
4. Complete the programming sequence by scanning the ENTER/EXIT Programming Mode barcode.



Set Code 93 Length 1

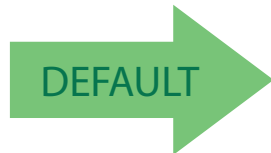

Default setting for this feature = 01



## Code 93 Length 2

If Code 93 Length Control is set to Fixed–Length decoding, this feature specifies Code 93 second fixed length. If Code 93 Length Control is set to Variable–Length decoding, this feature specifies the maximum label length.



**When in Fixed Length mode, if Fixed Length 2 is set to the value of 00 (zero), then only Length 1 will apply.**

**NOTE**

To set this feature:

1. Scan the Enter/Exit Programming Mode barcode at the top of the page.
2. Scan the barcode, [Set Code 93 Length 2 on page 232](#) below. You’ll need to cover any unused barcodes on this and the facing page to ensure that the scanner reads only the barcode you intend to scan.
3. Scan the appropriate digits from the [Alpha–Numeric Keypad in Appendix C](#) that represent the desired label length. The selectable range for this option is 00 (meaning ignore this length), or 01 to 50. Pad all single digit numbers with a leading zero to yield a two–digit entry (01–50).
4. Complete the programming sequence by scanning the ENTER/EXIT Programming Mode barcode.



Set Code 93 Length 2

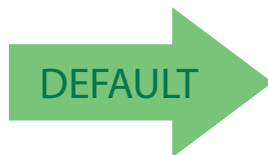

Default setting for this feature = 32 (length = 50)

## MSI

### MSI Enable

Enables/disables the ability of the scanner to decode MSI labels.

To set this feature:

1. Scan the Enter/Exit Programming Mode barcode at the top of the page.
2. Scan either the enable or disable barcode below. You'll need to cover any unused barcodes on this and the facing page to ensure that the scanner reads only the barcode you intend to scan.
3. Complete the programming sequence by scanning the ENTER/EXIT Programming Mode barcode.

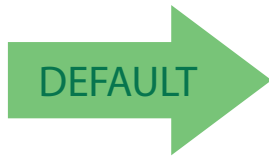

MSI = Disable



MSI = Enable



## MSI Check Character Calculation

Enables/disables calculation and verification of optional MSI check characters.



### NOTE

If check character calculation is disabled, the risk is increased that a misread can occur. When disabled, any check characters in a barcode are treated as data characters.

To set this feature:

1. Scan the Enter/Exit Programming Mode barcode at the top of the page.
2. Scan either the enable or disable barcode below. You'll need to cover any unused barcodes on this and the facing page to ensure that the scanner reads only the barcode you intend to scan.
3. Complete the programming sequence by scanning the ENTER/EXIT Programming Mode barcode.



MSI Check Character Calculation = Disable



MSI Check Character Calculation = Enable



## MSI Number of Check Characters

Specifies number of MSI check characters to be calculated and verified.



**Check characters are always modulus 10.**

### NOTE

To set this feature:

1. Scan the Enter/Exit Programming Mode barcode at the top of the page.
2. Scan the barcode below representing the desired number of MSI check characters to be calculated and verified. You'll need to cover any unused barcodes on this and the facing page to ensure that the scanner reads only the barcode you intend to scan.
3. Complete the programming sequence by scanning the ENTER/EXIT Programming Mode barcode.

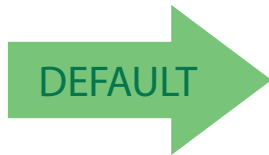

MSI Number of Check Characters = 1



MSI Number of Check Characters = 2

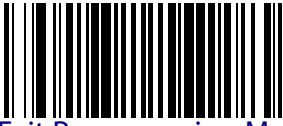

## MSI Check Character Transmission

Enables/disables transmission of optional MSI check characters.



### NOTE

This feature applies only when MSI Check Character Calculation on page 234 is enabled. This item is ignored when the advanced feature, Full Label Edit, is enabled.

To set this feature:

1. Scan the Enter/Exit Programming Mode barcode at the top of the page.
2. Scan either the enable or disable barcode below. You'll need to cover any unused barcodes on this and the facing page to ensure that the scanner reads only the barcode you intend to scan.
3. Complete the programming sequence by scanning the ENTER/EXIT Programming Mode barcode.



MSI Check Character Transmission = Disable



MSI Check Character Transmission = Enable



## MSI Minimum Read

This feature specifies the minimum number of consecutive MSI decodes before is accepted as good read.

To set this feature:

1. Scan the Enter/Exit Programming Mode barcode at the top of the page.
2. Scan your selection from the barcodes below. You'll need to cover any unused barcodes on this and the facing page to ensure that the scanner reads only the barcode you intend to scan.
3. Complete the programming sequence by scanning the ENTER/EXIT Programming Mode barcode.

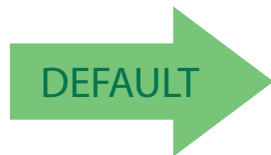

MSI Minimum Read = 1



MSI Minimum Read = 2



MSI Minimum Read = 3



MSI Minimum Read = 4

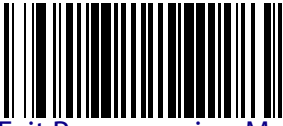

## MSI Length Control

This feature specifies whether variable-length or fixed-length decoding will be set for MSI.

To set this feature:

1. Scan the Enter/Exit Programming Mode barcode at the top of the page.
2. Scan your selection from the barcodes below. You'll need to cover any unused barcodes on this and the facing page to ensure that the scanner reads only the barcode you intend to scan.
3. Complete the programming sequence by scanning the ENTER/EXIT Programming Mode barcode.

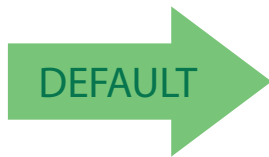

MSI Length Control = Variable Length



MSI Length Control = Fixed Length



## MSI Length 1

If MSI Length Control is set to Fixed–Length decoding, this feature specifies MSI first fixed length. If MSI Length Control is set to Variable–Length decoding, this feature specifies the minimum label length.

To set this feature:

1. Scan the Enter/Exit Programming Mode barcode at the top of the page.
2. Scan the barcode, [Set MSI Length 1 on page 239](#) below. You'll need to cover any unused barcodes on this and the facing page to ensure that the scanner reads only the barcode you intend to scan.
3. Scan the appropriate digits from the [Alpha–Numeric Keypad in Appendix C](#) that represent the desired label length. The selectable range for this option is 4 to 16. Pad all single digit numbers with a leading zero to yield a two–digit entry (04–16).
4. Complete the programming sequence by scanning the ENTER/EXIT Programming Mode barcode.



Set MSI Length 1

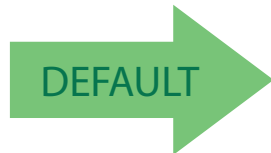

Default setting for this feature = 04

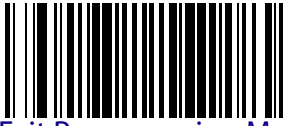

## MSI Length 2

If MSI Length Control is set to Fixed–Length decoding, this feature specifies MSI second fixed length. If MSI Length Control is set to Variable–Length decoding, this feature specifies the maximum label length.



**When in Fixed Length mode, if Length 2 is set to the value 00 (zero), then only Length 1 will apply.**

### NOTE

To set this feature:

1. Scan the Enter/Exit Programming Mode barcode at the top of the page.
2. Scan the barcode, [Set MSI Length 2 on page 240](#) below. You'll need to cover any unused barcodes on this and the facing page to ensure that the scanner reads only the barcode you intend to scan.
3. Scan the appropriate digits from the [Alpha–Numeric Keypad in Appendix C](#) that represent the desired label length. The selectable range for this option is 00 (meaning ignore this length), or 04 to 16. Pad all single digit numbers with a leading zero to yield a two–digit entry (00, 04–16).
4. Complete the programming sequence by scanning the ENTER/EXIT Programming Mode barcode.



Set MSI Length 2

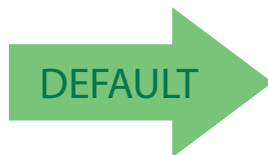

Default setting for this feature = 10 (length = 16)

## Standard 2 of 5

### Standard 2 of 5 Enable

Enables/disables the ability of the scanner to decode Standard 2 of 5 labels.

To set this feature:

1. Scan the Enter/Exit Programming Mode barcode at the top of the page.
2. Scan either the enable or disable barcode below. You'll need to cover any unused barcodes on this and the facing page to ensure that the scanner reads only the barcode you intend to scan.
3. Complete the programming sequence by scanning the ENTER/EXIT Programming Mode barcode.

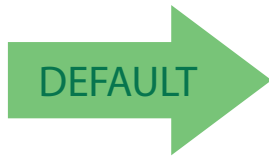

Standard 2 of 5 = Disable



Standard 2 of 5 = Enable



## Standard 2 of 5 Check Character Calculation

Enables/disables calculation and verification of an optional Standard 2 of 5 check character.



### NOTE

If check character calculation is disabled, the risk is increased that a misread can occur. When disabled, any check character in a barcode is treated as data character.

To set this feature:

1. Scan the Enter/Exit Programming Mode barcode at the top of the page.
2. Scan either the enable or disable barcode below. You'll need to cover any unused barcodes on this and the facing page to ensure that the scanner reads only the barcode you intend to scan.
3. Complete the programming sequence by scanning the ENTER/EXIT Programming Mode barcode.

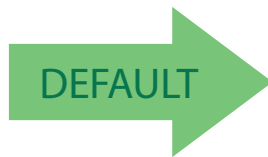

Standard 2 of 5 Check Character Calculation = Disable



Standard 2 of 5 Check Character Calculation = Enable

## Standard 2 of 5 Check Character Transmission

Enables/disables transmission of an optional Standard 2 of 5 check character.



### NOTE

This feature applies only when Standard 2 of 5 Check Character Calculation on page 242 is enabled. This item is ignored when the advanced feature, Full Label Edit, is enabled.

To set this feature:

1. Scan the Enter/Exit Programming Mode barcode at the top of the page.
2. Scan either the enable or disable barcode below. You'll need to cover any unused barcodes on this and the facing page to ensure that the scanner reads only the barcode you intend to scan.
3. Complete the programming sequence by scanning the ENTER/EXIT Programming Mode barcode.



Standard 2 of 5 Check Character Transmission = Disable



Standard 2 of 5 Check Character Transmission = Enable





## Standard 2 of 5 Minimum Read

This feature specifies the minimum number of consecutive Standard 2 of 5 decodes before is accepted as good read.

To set this feature:

1. Scan the Enter/Exit Programming Mode barcode at the top of the page.
2. Scan your selection from the barcodes below. You'll need to cover any unused barcodes on this and the facing page to ensure that the scanner reads only the barcode you intend to scan.
3. Complete the programming sequence by scanning the ENTER/EXIT Programming Mode barcode.

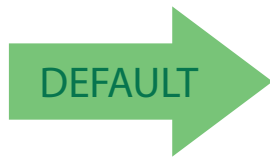

Standard 2 of 5 Minimum Read = 1



Standard 2 of 5 Minimum Read = 2



Standard 2 of 5 Minimum Read = 3



Standard 2 of 5 Minimum Read = 4

## Standard 2 of 5 Correlation

Enables/disables character correlation for Standard 2 of 5.

To set this feature:

1. Scan the Enter/Exit Programming Mode barcode at the top of the page.
2. Scan either the enable or disable barcode below. You'll need to cover any unused barcodes on this and the facing page to ensure that the scanner reads only the barcode you intend to scan.
3. Complete the programming sequence by scanning the ENTER/EXIT Programming Mode barcode.

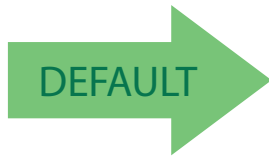

Standard 2 of 5 Correlation = Disable



Standard 2 of 5 Correlation = Enable



## Standard 2 of 5 Length Control

This feature specifies whether variable-length or fixed-length decoding will be set for Standard 2 of 5.

To set this feature:

1. Scan the Enter/Exit Programming Mode barcode at the top of the page.
2. Scan your selection from the barcodes below. You'll need to cover any unused barcodes on this and the facing page to ensure that the scanner reads only the barcode you intend to scan.
3. Complete the programming sequence by scanning the ENTER/EXIT Programming Mode barcode.

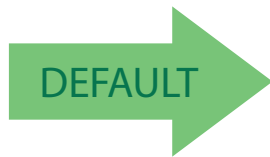

Standard 2 of 5 Length Control = Variable Length

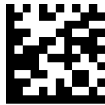

Standard 2 of 5 Length Control = Fixed Length



## Standard 2 of 5 Length 1

If Standard 2 of 5 Length Control is set to Fixed–Length decoding, this feature specifies Standard 2 of 5 first fixed length. If Standard 2 of 5 Length Control is set to Variable–Length decoding, this feature specifies the minimum label length.

To set this feature:

1. Scan the Enter/Exit Programming Mode barcode at the top of the page.
2. Scan the barcode, [Set Standard 2 of 5 Length 1 on page 247](#) below. You'll need to cover any unused barcodes on this and the facing page to ensure that the scanner reads only the barcode you intend to scan.
3. Scan the appropriate digits from the [Alpha–Numeric Keypad in Appendix C](#) that represent the desired label length. The selectable range for this option is 1 to 50. Pad all single digit numbers with a leading zero to yield a two–digit entry (01–50).
4. Complete the programming sequence by scanning the ENTER/EXIT Programming Mode barcode.



Set Standard 2 of 5 Length 1

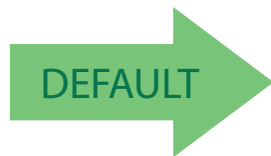

Default setting for this feature = 08

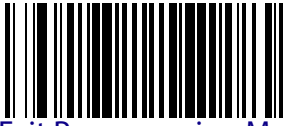

## Standard 2 of 5 Length 2

If Standard 2 of 5 Length Control is set to Fixed–Length decoding, this feature specifies Standard 2 of 5 second fixed length. If Standard 2 of 5 Length Control is set to Variable–Length decoding, this feature specifies the maximum label length.



**When in Fixed Length mode, if Length 2 is set to the value of 00 (zero), then only Length 1 will apply.**

### NOTE

To set this feature:

1. Scan the Enter/Exit Programming Mode barcode at the top of the page.
2. Scan the barcode, [Set Standard 2 of 5 Length 2 on page 248](#) below. You'll need to cover any unused barcodes on this and the facing page to ensure that the scanner reads only the barcode you intend to scan.
3. Scan the appropriate digits from the [Alpha–Numeric Keypad in Appendix C](#) that represent the desired label length. The selectable range for this option is 1 to 50. Pad all single digit numbers with a leading zero to yield a two–digit entry (01–50).
4. Complete the programming sequence by scanning the ENTER/EXIT Programming Mode barcode.



Set Standard 2 of 5 Length 2

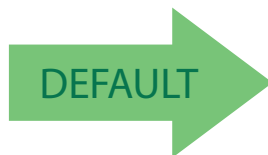

Default setting for this feature = 32 (length = 50)



## 2D Symbologies/Postal Codes



### NOTE

If the scanner's interface type must be changed, always be sure that interface configuration is the **FIRST** item scanned during a programming session. (Selecting an interface type resets **ALL** other configuration items — including symbology programming — to the factory default for that interface type.)

The following pages contain configuration information concerning the various 2D and Postal Code barcode types the scanner supports.

2D Codes
<b>DATA MATRIX</b> starting on page 250
<b>PDF 417</b> starting on page 254
<b>MICRO PDF 417</b> starting on page 258
<b>QR CODE</b> starting on page 262
<b>MICRO QR CODE</b> starting on page 267
<b>AZTEC CODE</b> starting on page 270
<b>HAN XIN CODE</b> starting on page 273
Postal Codes
<b>POSTNET</b> starting on page 274
<b>PLANET CODE</b> starting on page 275
<b>ROYAL MAIL</b> starting on page 276
<b>KIX</b> starting on page 277
<b>AUSTRALIA POST</b> starting on page 278
<b>JAPAN POST</b> starting on page 279
<b>IMB</b> starting on page 280
<b>SWEDEN POST</b> starting on page 281
<b>PORTUGAL POST</b> starting on page 282

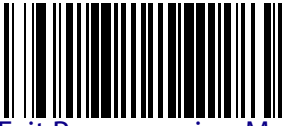

## Data Matrix

### Data Matrix Enable

Enables/disables the ability of the scanner to decode Data Matrix labels.

To set this feature:

1. Scan the Enter/Exit Programming Mode barcode at the top of the page.
2. Scan either the enable or disable barcode below. You'll need to cover any unused barcodes on this and the facing page to ensure that the scanner reads only the barcode you intend to scan.
3. Complete the programming sequence by scanning the Enter/Exit Programming Mode barcode.

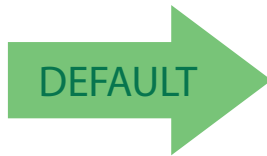

Data Matrix = Disable



Data Matrix = Enable

## Data Matrix Length Control

**Fixed Length Decoding** — When fixed length decoding is enabled, the scanner will decode a barcode if the label length matches one of the configurable fixed lengths.

**Variable Length Decoding** — When variable length decoding is enabled, the scanner will decode a barcode if the label length falls in the range of the configurable minimum and maximum length.

Configuring Fixed Length Decoding:

1. Scan the Enter/Exit Programming Mode barcode at the top of the page.
2. Scan the Fixed Length Decoding barcode.
3. Scan the Enter/Exit Programming Mode barcode at the top of the page.
4. Set Length 1 to the first fixed length using the [Data Matrix Length 1, Length 2 Programming Instructions on page 252](#) that follow this page.
5. Set Length 2 to the second fixed length (or to '0000' if there is only one fixed length) using the [Data Matrix Length 1, Length 2 Programming Instructions on page 252](#).

### Configuring Variable Length Decoding:

1. Scan the Enter/Exit Programming Mode barcode at the top of the page.
2. Scan the Variable Length Decoding barcode.
3. Scan the Enter/Exit Programming Mode barcode at the top of the page.
4. Set Length 1 to the minimum length using the [Data Matrix Length 1, Length 2 Programming Instructions on page 252](#) that follow this page.
5. Set Length 2 to the maximum length using the [Data Matrix Length 1, Length 2 Programming Instructions on page 252](#).

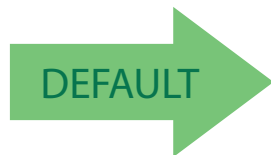

Data Matrix Length Control = Variable Length



Data Matrix Length Control = Fixed Length



### Data Matrix Length 1, Length 2 Programming Instructions

If Data Matrix Length Control is set to Fixed–Length decoding, this feature specifies Data Matrix first fixed length. If Data Matrix Length Control is set to Variable–Length decoding, this feature specifies the minimum label length.



**For Data Matrix barcodes, only the data characters are included in the length calculations.**

**NOTE**

To set this feature:

1. Scan the Enter/Exit Programming Mode barcode at the top of the page.
2. Scan the barcode, [Set Data Matrix Length 1 on page 252](#) or [Set Data Matrix Length 2 on page 252](#) below. You'll need to cover any unused barcodes on this and the facing page to ensure that the scanner reads only the barcode you intend to scan.
3. Scan the appropriate digits from the [Alpha–Numeric Keypad in Appendix C](#) that represent the desired label length. The selectable range for this option is 0001 to 3116. Pad all numbers with leading zeros to yield a four–digit entry (0001–3116).
4. Complete the programming sequence by scanning the ENTER/EXIT Programming Mode barcode.



Set Data Matrix Length 1  
Default setting for this feature = 0001



Set Data Matrix Length 2  
Default setting for this feature = 0320 (length = 800)

## GS1 Datamatrix Enable

Enables/disables the ability of the scanner to decode GS1 Datamatrix labels.

To set this feature:

1. Scan the Enter/Exit Programming Mode barcode at the top of the page.
2. Scan either the enable or disable barcode below. You'll need to cover any unused barcodes on this and the facing page to ensure that the scanner reads only the barcode you intend to scan.
3. Complete the programming sequence by scanning the Enter/Exit Programming Mode barcode.

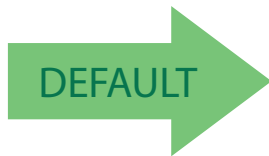

GS1 Datamatrix disabled



GS1 Datamatrix enabled



## PDF 417

### PDF 417 Enable

Enables the processing of PDF417 labels.

To set this feature:

1. Scan the Enter/Exit Programming Mode barcode at the top of the page.
2. Scan either the enable or disable barcode below. You'll need to cover any unused barcodes on this and the facing page to ensure that the scanner reads only the barcode you intend to scan.
3. Complete the programming sequence by scanning the Enter/Exit Programming Mode barcode.



PDF 417 = Disable



PDF 417 = Enable





## PDF 417 Length Control

**Fixed Length Decoding** — When fixed length decoding is enabled, the scanner will decode a barcode if the label length matches one of the configurable fixed lengths.

**Variable Length Decoding** — When variable length decoding is enabled, the scanner will decode a barcode if the label length falls in the range of the configurable minimum and maximum length.

Configuring Fixed Length Decoding:

1. Scan the Enter/Exit Programming Mode barcode at the top of the page.
2. Scan the Fixed Length Decoding barcode.
3. Scan the Enter/Exit Programming Mode barcode at the top of the page.
4. Set Length 1 to the first fixed length using the [PDF 417 Length 1, Length 2 Programming Instructions on page 256](#) that follow this page.
5. Set Length 2 to the second fixed length (or to '0000' if there is only one fixed length) using the [PDF 417 Length 1, Length 2 Programming Instructions on page 256](#).

### Configuring Variable Length Decoding:

1. Scan the Enter/Exit Programming Mode barcode at the top of the page.
2. Scan the Variable Length Decoding barcode.
3. Scan the Enter/Exit Programming Mode barcode at the top of the page.
4. Set Length 1 to the minimum length using the [PDF 417 Length 1, Length 2 Programming Instructions on page 256](#) that follow this page.
5. Set Length 2 to the maximum length using the [PDF 417 Length 1, Length 2 Programming Instructions on page 256](#).

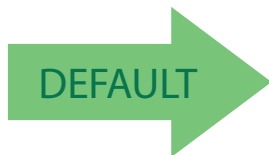

PDF 417 Length Control = Variable Length



PDF 417 Length Control = Fixed Length

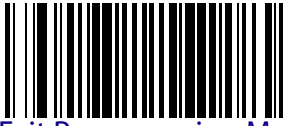

### PDF 417 Length 1, Length 2 Programming Instructions

If PDF417 Length Control is set to Fixed–Length decoding, this feature specifies PDF417 first fixed length. If PDF417 Length Control is set to Variable–Length decoding, this feature specifies the minimum label length.



**NOTE**

This tag is only valid for units with a model ID that supports PDF.

Length 1 is the minimum label length if in variable length mode, or the first fixed length if in fixed length mode. Length 2 is the maximum label length if in variable length mode, or the second fixed length if in fixed length mode. Length includes the barcode's data characters only. Any value > 2710 will be considered to be 2710.

To set this feature:

1. Scan the Enter/Exit Programming Mode barcode at the top of the page.
2. Scan the barcode, [Set PDF 417 Length 1 on page 256](#) or [Set PDF 417 Length 2 on page 256](#) below. You'll need to cover any unused barcodes on this and the facing page to ensure that the scanner reads only the barcode you intend to scan.
3. Scan the appropriate digits from the [Alpha–Numeric Keypad in Appendix C](#) that represent the desired label length. The selectable range for this option is 0001 to 2710. Pad all numbers with leading zeros to yield a four–digit entry (0001–2710).
4. Complete the programming sequence by scanning the ENTER/EXIT Programming Mode barcode.



Set PDF 417 Length 1  
Default setting for this feature = 0001



Set PDF 417 Length 2  
Default setting for this feature = 0A96 (length = 2710)

## PDF 417 Read Option

This feature specifies an additional read control option for PDF 417 barcodes. To set this feature:

1. Scan the Enter/Exit Programming Mode barcode at the top of the page.
2. Scan either the enable or disable barcode below. You'll need to cover any unused barcodes on this and the facing page to ensure that the scanner reads only the barcode you intend to scan.
3. Complete the programming sequence by scanning the Enter/Exit Programming Mode barcode.

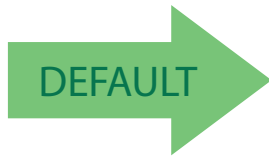

PDF 417 Read Option = None



PDF 417 Read Option = Turn Off Codeword  
Length Checking

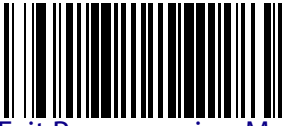

## Micro PDF 417

### Micro PDF 417 Enable

Enables/disables the ability of the scanner to decode Micro PDF 417 labels.  
To set this feature:

1. Scan the Enter/Exit Programming Mode barcode at the top of the page.
2. Scan either the enable or disable barcode below. You'll need to cover any unused barcodes on this and the facing page to ensure that the scanner reads only the barcode you intend to scan.
3. Complete the programming sequence by scanning the Enter/Exit Programming Mode barcode.

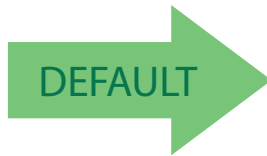

Micro PDF 417 = Disable



Micro PDF 417 = Enable

## Micro PDF 417 Length Control

**Fixed Length Decoding** — When fixed length decoding is enabled, the scanner will decode a barcode if the label length matches one of the configurable fixed lengths.

**Variable Length Decoding** — When variable length decoding is enabled, the scanner will decode a barcode if the label length falls in the range of the configurable minimum and maximum length.

Configuring Fixed Length Decoding:

1. Scan the Enter/Exit Programming Mode barcode at the top of the page.
2. Scan the Fixed Length Decoding barcode.
3. Scan the Enter/Exit Programming Mode barcode at the top of the page.
4. Set Length 1 to the first fixed length using the [Micro PDF 417 Length 1, Length 2 Programming Instructions on page 260](#) that follow this page.
5. Set Length 2 to the second fixed length (or to '0000' if there is only one fixed length) using the [Micro PDF 417 Length 1, Length 2 Programming Instructions on page 260](#).

### Configuring Variable Length Decoding:

1. Scan the Enter/Exit Programming Mode barcode at the top of the page.
2. Scan the Variable Length Decoding barcode.
3. Scan the Enter/Exit Programming Mode barcode at the top of the page.
4. Set Length 1 to the minimum length using the [Micro PDF 417 Length 1, Length 2 Programming Instructions on page 260](#) that follow this page.
5. Set Length 2 to the maximum length using the [Micro PDF 417 Length 1, Length 2 Programming Instructions on page 260](#).

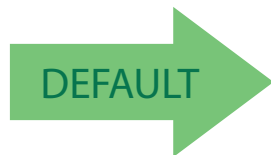

Micro PDF 417 Length Control = Variable Length



Micro PDF 417 Length Control = Fixed Length



### Micro PDF 417 Length 1, Length 2 Programming Instructions

If Micro PDF 417 Length Control is set to Fixed–Length decoding, this feature specifies Micro PDF 417 first fixed length. If Micro PDF 417 Length Control is set to Variable–Length decoding, this feature specifies the minimum label length.



**NOTE**

This tag is only valid for units with a model ID that supports PDF.

Length 1 is the minimum label length if in variable length mode, or the first fixed length if in fixed length mode. Length 2 is the maximum label length if in variable length mode, or the second fixed length if in fixed length mode. Length includes the barcode's data characters only. Any value > 0366 will be considered to be 0366.

To set this feature:

1. Scan the Enter/Exit Programming Mode barcode at the top of the page.
2. Scan the barcode, [Set Micro PDF 417 Length 1 on page 260](#) or [Set Micro PDF 417 Length 2 on page 260](#) below. You'll need to cover any unused barcodes on this and the facing page to ensure that the scanner reads only the barcode you intend to scan.
3. Scan the appropriate digits from the [Alpha–Numeric Keypad in Appendix C](#) that represent the desired label length. The selectable range for this option is 0001 to 0366. Pad all numbers with leading zeros to yield a four–digit entry (0001–0366).
4. Complete the programming sequence by scanning the ENTER/EXIT Programming Mode barcode.



Set Micro PDF 417 Length 1  
Default setting for this feature = 0001



Set Micro PDF 417 Length 2  
Default setting for this feature = 016E (length = 366)

## Micro PDF 417 128 Emulation

This feature specifies which AIM ID to use for Micro PDF 417 labels when performing Code 128 or EAN 128 emulation.

To set this feature:

1. Scan the Enter/Exit Programming Mode barcode at the top of the page.
2. Scan the barcode below for the desired setting. You'll need to cover any unused barcodes on this and the facing page to ensure that the scanner reads only the barcode you intend to scan.
3. Complete the programming sequence by scanning the Enter/Exit Programming Mode barcode.

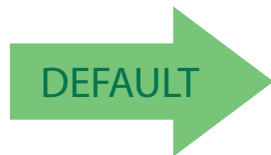

Micro PDF 417 128 Emulation = Micro PDF AIM ID and label type when emulating EAN128 or Code 128



Micro PDF 417 128 Emulation = Code 128 / EAN128 AIM ID and label type when emulating EAN128 or Code 128

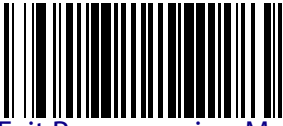

## QR Code

### QR Code Enable

Enables/disables the ability of the scanner to decode QR Code labels.

To set this feature:

1. Scan the Enter/Exit Programming Mode barcode at the top of the page.
2. Scan either the enable or disable barcode below. You'll need to cover any unused barcodes on this and the facing page to ensure that the scanner reads only the barcode you intend to scan.
3. Complete the programming sequence by scanning the Enter/Exit Programming Mode barcode.

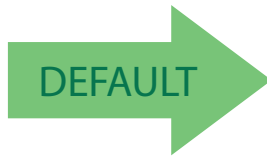

QR Code = Disable



QR Code = Enable



## QR Code Length Control

**Fixed Length Decoding** — When fixed length decoding is enabled, the scanner will decode a barcode if the label length matches one of the configurable fixed lengths.

**Variable Length Decoding** — When variable length decoding is enabled, the scanner will decode a barcode if the label length falls in the range of the configurable minimum and maximum length.

Configuring Fixed Length Decoding:

1. Scan the Enter/Exit Programming Mode barcode at the top of the page.
2. Scan the Fixed Length Decoding barcode.
3. Scan the Enter/Exit Programming Mode barcode at the top of the page.
4. Set Length 1 to the first fixed length using the [QR Code Length 1, Length 2 Programming Instructions on page 264](#) that follow this page.
5. Set Length 2 to the second fixed length (or to '0000' if there is only one fixed length) using the [QR Code Length 1, Length 2 Programming Instructions on page 264](#).

### Configuring Variable Length Decoding:

1. Scan the Enter/Exit Programming Mode barcode at the top of the page.
2. Scan the Variable Length Decoding barcode.
3. Scan the Enter/Exit Programming Mode barcode at the top of the page.
4. Set Length 1 to the minimum length using the [QR Code Length 1, Length 2 Programming Instructions on page 264](#) that follow this page.
5. Set Length 2 to the maximum length using the [QR Code Length 1, Length 2 Programming Instructions on page 264](#).

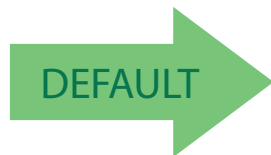

QR Code Length Control = Variable Length



QR Code Length Control = Fixed Length



## QR Code Length 1, Length 2 Programming Instructions

If QR Code Length Control is set to Fixed–Length decoding, this feature specifies QR Code first fixed length. If QR Code Length Control is set to Variable–Length decoding, this feature specifies the minimum label length.



### NOTE

Length 1 is the minimum label length if in variable length mode, or the first fixed length if in fixed length mode. Length 2 is the maximum label length if in variable length mode, or the second fixed length if in fixed length mode. Length includes the barcode's data characters only. Any value > 2710 will be considered to be 2710.

To set this feature:

1. Scan the Enter/Exit Programming Mode barcode at the top of the page.
2. Scan the barcode, [Set QR Code Length 1 on page 264](#) or [Set QR Code Length 2 on page 264](#) below. You'll need to cover any unused barcodes on this and the facing page to ensure that the scanner reads only the barcode you intend to scan.
3. Scan the appropriate digits from the [Alpha–Numeric Keypad in Appendix C](#) that represent the desired label length. The selectable range for this option is 0001 to 2710. Pad all numbers with leading zeros to yield a four–digit entry (001–02710).
4. Complete the programming sequence by scanning the ENTER/EXIT Programming Mode barcode.



Set QR Code Length 1  
Default setting for this feature = 0001



Set QR Code Length 2  
Default setting for this feature = 0A96 (length = 2710)

## QR Code URL Link Enable

Enables/Disables the decoding of QR codes with a URL link on imagers.

To set this feature:

1. Scan the Enter/Exit Programming Mode barcode at the top of the page.
2. Scan either the enable or disable barcode below. You'll need to cover any unused barcodes on this and the facing page to ensure that the scanner reads only the barcode you intend to scan.
3. Complete the programming sequence by scanning the Enter/Exit Programming Mode barcode.

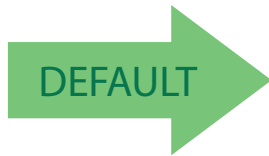

QR Code URL Link = Disable



QR Code URL Link = Enable

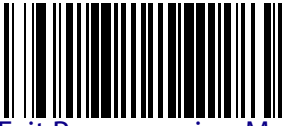

## GS1 QR Code Enable

This feature controls the ability of the scanner to decode GS1 QR Code labels.

To set this feature:

1. Scan the Enter/Exit Programming Mode barcode at the top of the page.
2. Scan either the enable or disable barcode below. You'll need to cover any unused barcodes on this and the facing page to ensure that the scanner reads only the barcode you intend to scan.
3. Complete the programming sequence by scanning the Enter/Exit Programming Mode barcode.

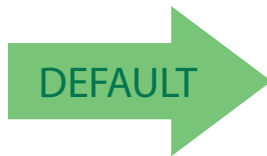

GS1 QR Code = Disable



GS1 QR Code = Enable

## Micro QR Code

### Micro QR Code Enable

Enables/disables the ability of the scanner to decode Micro QRCode labels.

To set this feature:

1. Scan the Enter/Exit Programming Mode barcode at the top of the page.
2. Scan either the enable or disable barcode below. You'll need to cover any unused barcodes on this and the facing page to ensure that the scanner reads only the barcode you intend to scan.
3. Complete the programming sequence by scanning the Enter/Exit Programming Mode barcode.

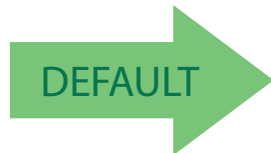

Micro QR Code = Disable

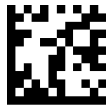

Micro QR Code = Enable



## Micro QR Code Length Control

**Fixed Length Decoding** — When fixed length decoding is enabled, the scanner will decode a barcode if the label length matches one of the configurable fixed lengths.

**Variable Length Decoding** — When variable length decoding is enabled, the scanner will decode a barcode if the label length falls in the range of the configurable minimum and maximum length.

Configuring Fixed Length Decoding:

1. Scan the Enter/Exit Programming Mode barcode at the top of the page.
2. Scan the Fixed Length Decoding barcode.
3. Scan the Enter/Exit Programming Mode barcode at the top of the page.
4. Set Length 1 to the first fixed length using the [Micro QR Code Length 1, Length 2 Programming Instructions on page 269](#) that follow this page.
5. Set Length 2 to the second fixed length (or to '0000' if there is only one fixed length) using the [Micro QR Code Length 1, Length 2 Programming Instructions on page 269](#).

### Configuring Variable Length Decoding:

1. Scan the Enter/Exit Programming Mode barcode at the top of the page.
2. Scan the Variable Length Decoding barcode.
3. Scan the Enter/Exit Programming Mode barcode at the top of the page.
4. Set Length 1 to the minimum length using the [Micro QR Code Length 1, Length 2 Programming Instructions on page 269](#) that follow this page.
5. Set Length 2 to the maximum length using the [Micro QR Code Length 1, Length 2 Programming Instructions on page 269](#).



Micro QR Code Length Control = Variable Length



Micro QR Code Length Control = Fixed Length

## Micro QR Code Length 1, Length 2 Programming Instructions

If Micro QR Code Length Control is set to Fixed–Length decoding, this feature specifies Micro QR Code first fixed length. If Micro QR Code Length Control is set to Variable–Length decoding, this feature specifies the minimum label length.



### NOTE

Length 1 is the minimum label length if in variable length mode, or the first fixed length if in fixed length mode. Length 2 is the maximum label length if in variable length mode, or the second fixed length if in fixed length mode. Length includes the barcode's data characters only. Any value > 3700 will be considered to be 3700.

To set this feature:

1. Scan the Enter/Exit Programming Mode barcode at the top of the page.
2. Scan the barcode, [Set Aztec Length 1 on page 272](#) or [Set Micro QR Code Length 2 on page 269](#) below. You'll need to cover any unused barcodes on this and the facing page to ensure that the scanner reads only the barcode you intend to scan.
3. Scan the appropriate digits from the [Alpha–Numeric Keypad in Appendix C](#) that represent the desired label length. The selectable range for this option is 0001 to 3700. Pad all numbers with leading zeros to yield a four–digit entry (0001–3700).
4. Complete the programming sequence by scanning the ENTER/EXIT Programming Mode barcode.



Set Micro QR Code Length 1  
Default setting for this feature = 0001



Set Micro QR Code Length 2  
Default setting for this feature = 0E74 (length = 3700)



## Aztec Code

### Aztec Enable

Enables/disables the ability of the scanner to decode Aztec labels.

To set this feature:

1. Scan the Enter/Exit Programming Mode barcode at the top of the page.
2. Scan either the enable or disable barcode below. You'll need to cover any unused barcodes on this and the facing page to ensure that the scanner reads only the barcode you intend to scan.
3. Complete the programming sequence by scanning the Enter/Exit Programming Mode barcode.

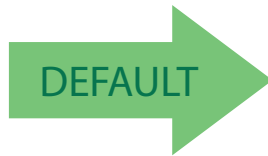

Aztec = Disable



Aztec = Enable



## Aztec Length Control

**Fixed Length Decoding** — When fixed length decoding is enabled, the scanner will decode a barcode if the label length matches one of the configurable fixed lengths.

**Variable Length Decoding** — When variable length decoding is enabled, the scanner will decode a barcode if the label length falls in the range of the configurable minimum and maximum length.

Configuring Fixed Length Decoding:

1. Scan the Enter/Exit Programming Mode barcode at the top of the page.
2. Scan the Fixed Length Decoding barcode.
3. Scan the Enter/Exit Programming Mode barcode at the top of the page.
4. Set Length 1 to the first fixed length using the [Aztec Length 1, Length 2 Programming Instructions on page 272](#) that follow this page.
5. Set Length 2 to the second fixed length (or to '0000' if there is only one fixed length) using the [Aztec Length 1, Length 2 Programming Instructions on page 272](#).

### Configuring Variable Length Decoding:

1. Scan the Enter/Exit Programming Mode barcode at the top of the page.
2. Scan the Variable Length Decoding barcode.
3. Scan the Enter/Exit Programming Mode barcode at the top of the page.
4. Set Length 1 to the minimum length using the [Aztec Length 1, Length 2 Programming Instructions on page 272](#) that follow this page.
5. Set Length 2 to the maximum length using the [Aztec Length 1, Length 2 Programming Instructions on page 272](#).

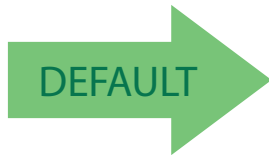

Aztec Length Control = Variable Length



Aztec Length Control = Fixed Length



## Aztec Length 1, Length 2 Programming Instructions

If Aztec Length Control is set to Fixed–Length decoding, this feature specifies Aztec first fixed length. If Aztec Length Control is set to Variable–Length decoding, this feature specifies the minimum label length.



### NOTE

**Length 1 is the minimum label length if in variable length mode, or the first fixed length if in fixed length mode. Length 2 is the maximum label length if in variable length mode, or the second fixed length if in fixed length mode. Length includes the barcode's data characters only. Any value > 3700 will be considered to be 3700.**

To set this feature:

1. Scan the Enter/Exit Programming Mode barcode at the top of the page.
2. Scan the barcode, [Set Aztec Length 1 on page 272](#) or [Set Aztec Length 2 on page 272](#) below. You'll need to cover any unused barcodes on this and the facing page to ensure that the scanner reads only the barcode you intend to scan.
3. Scan the appropriate digits from the [Alpha–Numeric Keypad in Appendix C](#) that represent the desired label length. The selectable range for this option is 0001 to 3700. Pad all numbers with leading zeros to yield a four–digit entry (0001–3700).
4. Complete the programming sequence by scanning the ENTER/EXIT Programming Mode barcode.



Set Aztec Length 1  
Default setting for this feature = 0001



Set Aztec Length 2  
Default setting for this feature = 0E74 (length = 3700)

## Han Xin Code

### Han Xin Enable

Enables/disables the ability of the scanner to decode Han Xin labels.

To set this feature:

1. Scan the Enter/Exit Programming Mode barcode at the top of the page.
2. Scan either the enable or disable barcode below. You'll need to cover any unused barcodes on this and the facing page to ensure that the scanner reads only the barcode you intend to scan.
3. Complete the programming sequence by scanning the Enter/Exit Programming Mode barcode.

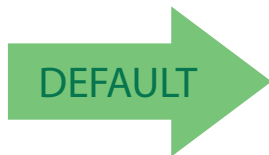

Han Xin Code = Disable



Han Xin Code = Enable

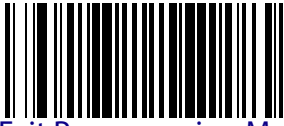

## POSTAL CODE SELECTION

Enables/disables the ability of the scanner to decode labels of the specified postal symbology.

### Postnet

#### Postnet Enable

Enables/disables the ability of the scanner to decode Postnet labels.

To set this feature:

1. Scan the Enter/Exit Programming Mode barcode at the top of the page.
2. Scan either the enable or disable barcode below. You'll need to cover any unused barcodes on this and the facing page to ensure that the scanner reads only the barcode you intend to scan.
3. Complete the programming sequence by scanning the Enter/Exit Programming Mode barcode.

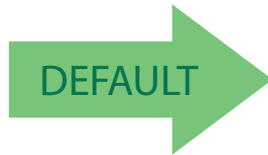

Postnet = Disable



Postnet = Enable

## Planet Code

### Planet Code Enable

Enables/disables the ability of the scanner to decode Planet Code labels.

To set this feature:

1. Scan the Enter/Exit Programming Mode barcode at the top of the page.
2. Scan either the enable or disable barcode below. You'll need to cover any unused barcodes on this and the facing page to ensure that the scanner reads only the barcode you intend to scan.
3. Complete the programming sequence by scanning the Enter/Exit Programming Mode barcode.

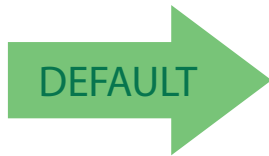

Planet Code = Disable



Planet Code = Enable



## Royal Mail

### Royal Mail Enable

Enables/disables the ability of the scanner to decode Royal Mail labels.

To set this feature:

1. Scan the Enter/Exit Programming Mode barcode at the top of the page.
2. Scan either the enable or disable barcode below. You'll need to cover any unused barcodes on this and the facing page to ensure that the scanner reads only the barcode you intend to scan.
3. Complete the programming sequence by scanning the Enter/Exit Programming Mode barcode.

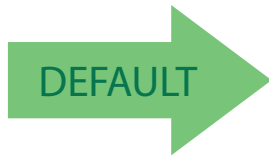

Royal Mail = Disable



Royal Mail = Enable

## Kix

### Kix Enable

Enables/disables the ability of the scanner to decode Kix labels.

To set this feature:

1. Scan the Enter/Exit Programming Mode barcode at the top of the page.
2. Scan either the enable or disable barcode below. You'll need to cover any unused barcodes on this and the facing page to ensure that the scanner reads only the barcode you intend to scan.
3. Complete the programming sequence by scanning the Enter/Exit Programming Mode barcode.

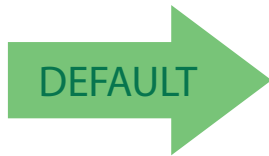

Kix = Disable



Kix = Enable

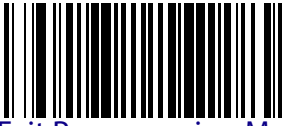

## Australia Post

### Australian Post Enable

Enables/disables the ability of the scanner to decode Australia Post labels.  
To set this feature:

1. Scan the Enter/Exit Programming Mode barcode at the top of the page.
2. Scan either the enable or disable barcode below. You'll need to cover any unused barcodes on this and the facing page to ensure that the scanner reads only the barcode you intend to scan.
3. Complete the programming sequence by scanning the Enter/Exit Programming Mode barcode.

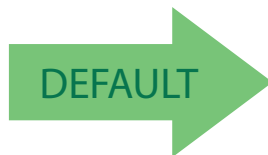

Australia Post = Disable



Australia Post = Enable



## Japan Post

### Japan Post Enable

Enables/disables the ability of the scanner to decode Japan Post labels.

To set this feature:

1. Scan the Enter/Exit Programming Mode barcode at the top of the page.
2. Scan either the enable or disable barcode below. You'll need to cover any unused barcodes on this and the facing page to ensure that the scanner reads only the barcode you intend to scan.
3. Complete the programming sequence by scanning the Enter/Exit Programming Mode barcode.

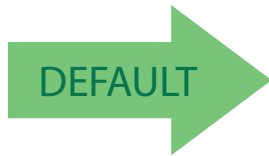

Japan Post = Disable



Japan Post = Enable

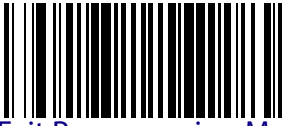

## IMB

### IMB Enable

Enables/disables the ability of the scanner to decode IMB labels.

To set this feature:

1. Scan the Enter/Exit Programming Mode barcode at the top of the page.
2. Scan either the enable or disable barcode below. You'll need to cover any unused barcodes on this and the facing page to ensure that the scanner reads only the barcode you intend to scan.
3. Complete the programming sequence by scanning the Enter/Exit Programming Mode barcode.

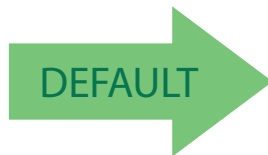

IMB = Disable



IMB = Enable

## Sweden Post

### Sweden Post Enable

Enables/disables the ability of the scanner to decode Sweden Post labels.  
To set this feature:

1. Scan the Enter/Exit Programming Mode barcode at the top of the page.
2. Scan either the enable or disable barcode below. You'll need to cover any unused barcodes on this and the facing page to ensure that the scanner reads only the barcode you intend to scan.
3. Complete the programming sequence by scanning the Enter/Exit Programming Mode barcode.

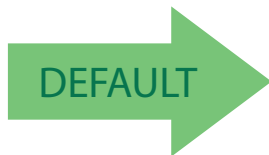

Sweden Post = Disable



Sweden Post = Enable

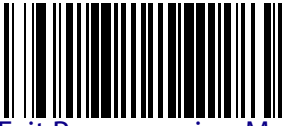

## Portugal Post

### Portugal Post Enable

Enables/disables the ability of the scanner to decode Portugal Post labels.

To set this feature:

1. Scan the Enter/Exit Programming Mode barcode at the top of the page.
2. Scan either the enable or disable barcode below. You'll need to cover any unused barcodes on this and the facing page to ensure that the scanner reads only the barcode you intend to scan.
3. Complete the programming sequence by scanning the Enter/Exit Programming Mode barcode.

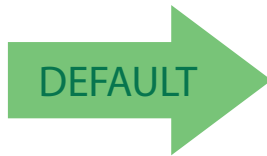

Portugal Post = Disable



Portugal Post = Enable



## Chapter 3 References

This section contains explanations and examples of selected barcode features. See the programming sections for the actual barcode labels used to configure the reader.

### Global Prefix/Suffix

Up to 20 ASCII characters may be added as a prefix (in a position before the barcode data) and/or as a suffix (in a position following the barcode data) as indicated in Figure 7.

Figure 7. Prefix and Suffix Positions

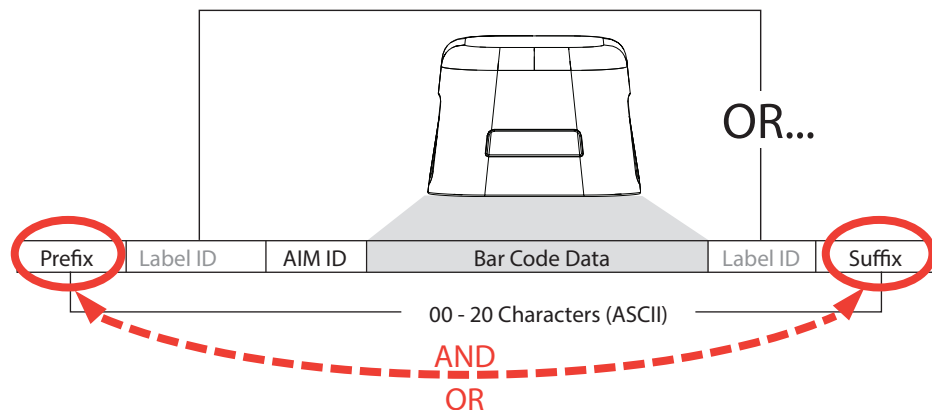

#### Example: Setting a Prefix

In this example, we'll set a prefix for all symbologies.

1. Determine which ASCII character(s) are to be added to scanned barcode data. In this example, we'll add a dollar sign ('\$') as a prefix.
2. Scan the Enter/Exit Programming Mode barcode at the top of the page.
3. Scan the SET PREFIX barcode.
4. Reference the [ASCII Character Set on page i](#) on the inside back cover of this manual, to find the hex value assigned to the desired character. The corresponding hex number for the '\$' character is 24. To enter this selection code, scan the '2' and '4' barcodes from [Appendix C, Alpha-Numeric Keypad](#).

5. Scan the END barcode once to finish the string, then scan END again to exit Programming Mode.



**NOTE**

If all 20 characters will be used in the prefix or suffix, do not scan the END barcode to finish the string. It is done automatically.

6. The resulting message string would appear as follows:

Scanned barcode data:12345

Resulting message string output: \$12345

## Label ID

A Label ID is used to identify a barcode (symbology) type. It can be appended previous to or following the transmitted barcode data depending upon how this option is enabled. This feature provides options for configuring custom Label IDs individually per symbology. If you wish to program the scanner to always include an industry standard label identifier for ALL symbology types, see the feature, [AIM ID](#) on page 101.

The Label ID is a customizable code of up to three ASCII characters (each of which are hex 00–7F) followed by a control character (00–01). This control character, when set to zero, does nothing. When set to one, it appends the symbology’s AIM ID to the Label ID.



**NOTE**

When the control character is set to 01 for UPC-A and UPC-E, it expands the label to EAN-13 and thus follows the EAN-13 Label ID settings.

**Figure 8. Label ID Position Options**

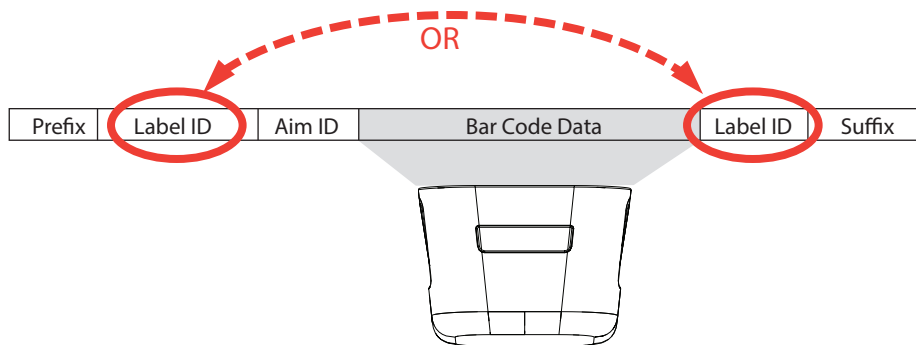

See [Label ID](#) on page 102 for programming barcodes. See [Appendix D, Factory Default Settings](#), for a listing of common symbologies.

## Label ID

Symbology	Default Character	Default ASCII
ANKER PLESSEY	o	6F0000
AZTEC	Az	417A00
Han Xin	\$S	245300
CODABAR	%	250000
CODE11	CE	434500
CODE128	#	230000
CODE32	A	410000
CODE39	*	2A0000
CODE39 CIP	Y	590000
CODE39 DANISH PPT	\$Y	245900
CODE39 LAPOSTE	\$Y	245900
CODE39 PZN	\$Z	245A00
CODE93	&	260000
DATABAR 14	R4	523400
DATABAR 14 COMPOSITE	R4	523400
DATABAR EXPANDED	RX	525800
DATABAR EXPANDED COMPOSITE	RX	525800
DATABAR LIMITED	RL	524C00
DATABAR LIMITED COMPOSITE	RL	524C00
DATA MATRIX	Dm	446D00
DATA MATRIX GS1	Dg	446700
EAN128		000001
EAN13	F	460000
EAN13 P2	F	460000
EAN13 P5	F	460000
EAN13 COMPOSITE	F	460000
EAN8	FF	464600
EAN8 P2	FF	464600
EAN8 P5	FF	464600

<b>Symbology</b>	<b>Default Character</b>	<b>Default ASCII</b>
EAN8 COMPOSITE	FF	464600
FOLLET 2OF5	O	4F0000
GTIN	G	470000
GTIN2	G2	473200
GTIN5	G5	473500
I2OF5	i	690000
I2OF5 CIP HR	e	650000
IATA INDUSTRIAL 2OF5	IA	494100
ISBN	l	490000
ISBT128 CONCAT	f	660000
ISSN	n	6E0000
MICRO QR	\$Q	245100
MICRO PDF	mP	6D5000
MSI	@	400000
PDF417	P	500000
PLESSEY	a	610000
POSTAL AUSTRALIAN	\$K	244B00
POSTAL IMB	\$V	245600
POSTAL JAPANESE	\$R	245200
POSTAL KIX	\$U	245500
POSTAL PLANET	\$W	245700
POSTAL PORTUGAL	\$P	245000
POSTAL POSTNET BB	\$L	244C00
POSTAL ROYAL MAIL	\$M	244D00
POSTAL SWEDISH	\$X	245800
QR CODE	QR	515200
QR CODE GS1	QG	514700
S25	s	730000
TRIOPTIC	\$T	245400
UPCA	A	410000



---

<b>Symbology</b>	<b>Default Character</b>	<b>Default ASCII</b>
UPCA P2	A	410000
UPCA P5	A	410000
UPCA COMPOSITE	A	410000
UPCE	E	450000
UPCE P2	E	450000
UPCE P5	E	450000
UPCE COMPOSITE	E	450000

## Length Control

**Fixed Length Decoding** — When fixed length decoding is enabled, the scanner will decode a barcode if the label length matches one of the configurable fixed lengths.

**Variable Length Decoding** — When variable length decoding is enabled, the scanner will decode a barcode if the label length falls in the range of the configurable minimum and maximum length.

### Configuring Fixed Length Decoding:

1. Scan the Enter/Exit Programming Mode barcode at the top of the page.
2. Scan the Fixed Length Decoding barcode for the desired symbology.
3. Scan the Enter/Exit Programming Mode barcode at the top of the page.
4. Set Length 1 to the first fixed length by following the [Length 1, Length 2 Programming Instructions](#) below.
5. Set Length 2 to the second fixed length (or to '00' if there is only one fixed length) by following the [Length 1, Length 2 Programming Instructions](#) below.

### Configuring Variable Length Decoding:

1. Scan the Enter/Exit Programming Mode barcode at the top of the page.
2. Scan the Variable Length Decoding barcode for the desired symbology.
3. Scan the Enter/Exit Programming Mode barcode at the top of the page.
4. Set Length 1 to the first variable length by following the [Length 1, Length 2 Programming Instructions](#) below.
5. Set Length 2 to the second variable length by following the [Length 1, Length 2 Programming Instructions](#) below.

## Length 1, Length 2 Programming Instructions

1. Scan the Enter/Exit Programming Mode barcode at the top of the page.
2. Scan either the Set Length 1 or Set Length 2 barcode for the desired symbology.
3. Turn to [Appendix C](#) and scan the two digits (zero padded) representing the length in decimal notation. The number of characters that can be set varies, depending upon the symbology. Reference the page for your selected symbology to see specific variables.
4. Scan the Enter/Exit Programming Mode barcode at the top of the page.



# Appendix A

## Product Specifications

### Decoding Capability

Parameter	Specification
1D / Linear Codes	Autodiscriminates All Standard 1D Codes Including GS1 Databar™ Linear Codes.
2D Codes	Aztec Code; Data Matrix; QR Code
Stacked Codes	GS1 Databar Composites; GS1 Databar Expanded Stacked; GS1 Databar Stacked; GS1 Databar Stacked Omnidirectional; Micro-PDF417; PDF417
Postal Codes	Australian Post; British Post; Canadian Post; China Post; IMB; Japanese Post; KIX Post; Planet Code; Portuguese Post; Postnet; Royal Mail Code (RM4SCC); Swedish Post
Digital Watermarks	Optional Support For Digimarc® Barcodes/GS1 DW Code

### Electrical

Parameter	Specification
Input Voltage	5 VDC +/- 10%;
Current	Operating (Typical): < 500 mA Standby/Idle (Typical): < 300 mA

## Environmental

Parameter	Specification
Ambient Light	0 - 86,100 Lux
Drop Resistance	Withstands repeated drops from 1.2 m / 4.0 ft onto a concrete surface
ESD Protection (Air Discharge)	25 kV
Humidity (Non-condensing)	5 - 95%
Particulate And Water Sealing	IP52
Temperature	Operating: 0 to 40 °C / 32 to 104 °F Storage/Transport: -40 to 70 °C / -40 to 158 °F

## Interfaces

Parameter	Specification
Interfaces	USB Keyboard; USB COM; OEM (IBM) USB; RS-232

## Optional Features

Parameter	Specification
EAS Features	Checkpoint Systems: Integrated EAS hardware will work with Counterpoint IX and Evolve D11 models Good Read Acknowledgment
Value Added Features	Diagnostic Reporting; Host Download; Magellan ULE Scripting

## Physical Characteristics

Parameter	Specification
Dimensions	Black; White
Dimensions	Tilting Riser: 6.0x7.5x15.0cm / 2.4x3.0x5.9in Stand: 6.0 x 7.5 x 10.6 cm / 2.4 x 3.0 x 4.2 in
Weight	Tilting Riser: 240.0 g / 8.5 oz

## Reading Performance

Parameter	Specification
Aiming	LED aimer for precision scanning
Image Capture	1 MP; 1280 x 800 pixels; Graphic Formats: BMP, JPEG
Print Contrast Ratio (Minimum)	25%
Read Height	14.0 cm / 5.5 in
Reading Angle	Pitch: +/- 65°; Roll (Tilt): 0 - 360°; Skew (Yaw): +/- 75°
Reading Indicators	Beeper (Adjustable Tone and Volume); Datalogic 'Green Spot' Good Read Feedback; Good Read LED
Resolution (Maximum)	0.130 mm / 5 Mils

## Reading Ranges

Parameter	Specification
Typical Depth Of Field	Printing Resolution, Symbol Length, Scan Angle, Contrast and Ambient Light Dependent
1D / Linear Codes	5 mils: 2.5 to 9.0 cm / 0.9 to 3.5 in
	7.5 mils: 0 to 17.0 cm / 0 to 6.6 in
	10 mils: 0 to to 21 cm / 0 to 8.2 in
	13 mils: UPC: 0 to 25.0 cm / 0 to 9.8 in
	20 mils: 1.0 to 30.0 cm / 0.4 to 11.8 in
2D Codes (Optional)	6.5 mils PDF: 2.5 to 11.0 cm / 0.9 to 4.3 in
	13 mils Data Matrix: 0 to 17.0 cm / 0 to 6.7 in
	16 mils PDF: 0 to 2.0 cm / 0 to 7.8 in
	24 mils Data Matrix: 0 to 25.0 cm / 0 to 9.8 in

## Safety & Regulatory

Parameter	Specification
Agency Approvals	The product meets necessary safety and regulatory approvals for its intended use.
Environmental Compliance	Complies to China RoHS; Complies to EU RoHS
LED Classification	EN62471 and IEC62471 Lamp Illumination
Safety Standards	UL/EN/IEC62368-1 and UL/EN/IEC60950-1

## Utilities

Parameter	Specification
Aladdin and Scanalyzer	Either Aladdin or Scanalyzer can be used for scanner configuration. Both are available for download at no charge.
OPOS / JavaPOS	JavaPOS Utilities are available for download at no charge. OPOS Utilities are available for download at no charge.
Remote Host Download	Lowers service costs and improves operations.

## Warranty

Warranty	3-year Factory Warranty
----------	-------------------------

## LED and Beeper Indicators

The scanner's beeper sounds and its green LED illuminates to indicate various functions or errors on the scanner. The tables below list these indications. The scanner's functions are programmable, and so may or may not be turned on. For example, certain indications such as the power-up beep can be disabled using programming barcode labels.

LED INDICATION	INDICATION	COMMENT
Power-on indication	Bright green flash	Indicates the scanner has finished all its power up tests and is now ready for operation.
Good Read Indication	Bright green flash	Indicates a barcode has been read and decoded.
Scanner Ready	Constant dim green	The scanner is ready for operation. The LED is also configurable to off when idle and ready for operation
Sleep Mode	Green LED slowly and continuously changes from off to dim to off.	The scanner is in Sleep Mode. To wake the scanner up, move an object in front of its window or press the button atop the unit. This indication is configurable and may be programmed to behave differently.
Host Disable	Constant green flash at 1 Hz (100mS on, 900mS off)	The scanner is disabled due to receiving a disable command from the POS terminal.
Diagnostics	Varies (see Error Codes on page 294 for more information)	The LED can provide diagnostic feedback if the scanner discovers a problem during SelfTest.
Prog. Mode	See Host Disable above.	The scanner is in Programming Mode.

### BEEPER FUNCTIONS

BEEPER INDICATION	INDICATION	COMMENT
Power On Beep	Single beep	The Power-On Beep indication is a configurable feature which can be enabled or disabled. When enabled, this beep Indicates the scanner has finished all its power up tests and is now ready for operation.
Good Read Indication	Single beep	The good read beep indication is configurable. Options include: Enable/disable, frequency, duration and volume. See <a href="#">LED and Beeper Indicators</a> on page 2-57 for more information.
Diagnostics	Varies (see " <a href="#">Error Codes</a> " for more information)	The Beeper can provide diagnostic feedback if the scanner discovers a problem during SelfTest.
Programming Mode Indications	Varies depending upon the feature(s) being configured.	The Beeper will sound as programming barcode labels are scanned, indicating progress during scanner configuration.

## Error Codes

If an error is detected, the scanner will sound a long low tone (for three seconds) and flash its LED, indicating a failure. When this occurs, press the Scanner Pushbutton to hear the error code. If it is configured to do so, the scanner will sound a series of beeps corresponding to the error code and/or flash its LED simultaneous to the beeps. The table below describes what these codes mean and what action should be taken for each.

<b>NUMBER OF LED FLASHES/ BEEPS</b>	<b>ERROR</b>	<b>CORRECTIVE ACTION</b>
1	Configuration	Contact Helpdesk for assistance
2	Interface PCB	
6	Main PCB	
10	Button Error	
12	Imager Module	
13	Software ID Failure	
14	Software Fatal Fault	





# Appendix B Cable Pinouts

## Standard Cable Pinouts (Primary Interface Cables)

Pin #	RS-232	USB, USB Keyboard, USB COM, USB-OEM
1		D+
2	CTS	
3		D-
4	RTS	
5	RxD	
6	TxD	
7	ERI	
8	Vin	VBUS
9	GND	GND



## Appendix C Alpha-Numeric Keypad



A



B



C



D

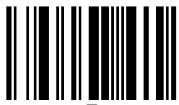

E



F



1



NOTE

For numeric entry sequences, the scanner will announce the number of digits remaining to be entered after each label read.



2

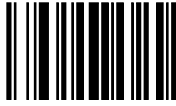

3



4

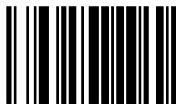

5



6



7



8



9



0



# Appendix D

## Factory Default Settings

The following table provides a listing of the most common factory settings for the interfaces shown.



**NOTE**

Some of the individual interfaces listed in the defaults table below appear in the same column since they share similar feature settings with few (if any) exceptions.

Keep in mind though, that the actual configuration storage area for each interface is unique and that updates & changes to factory defaults can be made at any time without notice.

### Factory Default Settings

Feature	Default Master	RS-232	RS-232 Wincor-Nixdorf	Keyboard	USB COM / USB TEC	USB OEM
<b>General Scanner Features</b>						
1D Double Read Timeout on page 16	28 (400ms)	28 (400ms)	28 (400ms)	28 (400ms)	28 (400ms)	28 (400ms)
2D Double Read Timeout on page 17	46 (700ms)	46 (700ms)	46 (700ms)	46 (700ms)	46 (700ms)	46 (700ms)
Double Read Table Size on page 18	7 entries	7 entries	7 entries	7 entries	7 entries	7 entries
Digital Watermark (Digimarc) Enable on page 19	01 (enable)	01 (enable)	01 (enable)	01 (enable)	01 (enable)	01 (enable)
Digital Watermark (Digimarc) Double Read Timeout on page 20	32 (0.5 Sec.)	32 (0.5 Sec.)	32 (0.5 Sec.)	32 (0.5 Sec.)	32 (0.5 Sec.)	32 (0.5 Sec.)
Digital Watermark (Digimarc) Data Format on page 21	00 (compatibility mode)	00 (compatibility mode)	00 (compatibility mode)	00 (compatibility mode)	00 (compatibility mode)	00 (compatibility mode)
1D Inverse Read Control on page 22	00 (disable)	00 (disable)	00 (disable)	00 (disable)	00 (disable)	00 (disable)
2D Inverse Read Control on page 23	00 (disable)	00 (disable)	00 (disable)	00 (disable)	00 (disable)	00 (disable)
Handheld State on page 24	01 (enable)	01 (enable)	01 (enable)	01 (enable)	01 (enable)	01 (enable)
Center Zone Enable on page 25	0 (off)	0 (off)	0 (off)	0 (off)	0 (off)	0 (off)

Feature	Default Master	RS-232	RS-232 Wincor-Nixdorf	Keyboard	USB COM / USB TEC	USB OEM
Center Zone Size on page 26	0A (10 percent)	0A (10 percent)	0A (10 percent)	0A (10 percent)	0A (10 percent)	0A (10 percent)
Sleep Mode Timer on page 27	5 minutes	5 minutes	5 minutes	5 minutes	5 minutes	5 minutes
Accelerometer Detect Threshold on page 28	01 (low)	01 (low)	01 (low)	01 (low)	01 (low)	01 (low)
Accelerometer Reject Threshold on page 29	2 (medium)	2 (medium)	2 (medium)	2 (medium)	2 (medium)	2 (medium)
Accelerometer Delay To Stationary on page 30	96 (150 mS)	96 (150 mS)	96 (150 mS)	96 (150 mS)	96 (150 mS)	96 (150 mS)
Accelerometer Inmotion Threshold on page 31	01 (low)	01 (low)	01 (low)	01 (low)	01 (low)	01 (low)
Power On Alert on page 32	01 (play tone)	01 (play tone)	01 (play tone)	01 (play tone)	01 (play tone)	01 (play tone)
External Read Indicator (ERI) on page 33	00 (low)	00 (low)	00 (low)	00 (low)	00 (low)	00 (low)
ERI Timeout on page 34	02 (20 mS)	02 (20 mS)	02 (20 mS)	02 (20 mS)	02 (20 mS)	02 (20 mS)
Good Read LED Idle State on page 35	02 (on dim)	02 (on dim)	02 (on dim)	02 (on dim)	02 (on dim)	02 (on dim)
Scanner Control Button Options on page 36	01	01	01	01	01	01
Good Read Beep Control on page 37	01 (enable)	01 (enable)	01 (enable)	01 (enable)	01 (enable)	01 (enable)
Good Read Beep Frequency on page 38	01 (med.)	01 (med.)	01 (med.)	01 (med.)	01 (med.)	01 (med.)
Good Read Beep Length on page 39	008 (80ms)	008 (80ms)	008 (80ms)	008 (80ms)	008 (80ms)	008 (80ms)
Good Read Beep Volume on page 40	02 (med)	02 (med)	02 (med)	02 (med)	02 (med)	02 (med)
Good Read When to Indicate on page 41	00 (after decode)	00 (after decode)	00 (after decode)	00 (after decode)	00 (after decode)	00 (after decode)
Illumination During Disable Mode on page 42	01 (enable)	01 (enable)	01 (enable)	01 (enable)	01 (enable)	01 (enable)
Object Sense Control on page 43	40 (enable)	40 (enable)	40 (enable)	40 (enable)	40 (enable)	40 (enable)
Reading Illumination Duration on page 44	64 (5 sec)	64 (5 sec)	64 (5 sec)	64 (5 sec)	64 (5 sec)	64 (5 sec)
Illumination Blank on Beep on page 45	00 (disable)	00 (disable)	00 (disable)	00 (disable)	00 (disable)	00 (disable)
Green Spot Duration Time on page 46	5 (50 mS)	5 (50 mS)	5 (50 mS)	5 (50 mS)	5 (50 mS)	5 (50 mS)

Feature	Default Master	RS-232	RS-232 Wincor-Nixdorf	Keyboard	USB COM / USB TEC	USB OEM
<b>Imaging Features</b>						
Image Destination on page 49	00 (disable)	00 (disable)	00 (disable)	00 (disable)	00 (disable)	00 (disable)
Picture Retrieval Timeout on page 50	05 (5 sec.)	05 (5 sec.)	05 (5 sec.)		05 (5 sec.)	05 (5 sec.)
Image Capture Delay on page 52	05 (5 sec.)	05 (5 sec.)	05 (5 sec.)	05 (5 sec.)	05 (5 sec.)	05 (5 sec.)
Image Format on page 53	00 (JPG)	00 (JPG)	00 (JPG)	00 (JPG)	00 (JPG)	00 (JPG)
Image Size on page 54	00 (VGA)	00 (VGA)	00 (VGA)	00 (VGA)	00 (VGA)	00 (VGA)
Image Brightness on page 55	Level 0	Level 0	Level 0	Level 0	Level 0	Level 0
Image Contrast on page 57	Level 0	Level 0	Level 0	Level 0	Level 0	Level 0
Image Compression on page 59	64 (Compression = 100)	64 (Compression = 100)	64 (Compression = 100)	64 (Compression = 100)	64 (Compression = 100)	64 (Compression = 100)
Region of Interest (ROI) on page 60	000004FF00003FF (full size)	000004FF00003FF (full size)	000004FF00003FF (full size)	000004FF00003FF (full size)	000004FF00003FF (full size)	000004FF00003FF (full size)
Number of Imager Frames on page 62	0	0	0	0	0	0
Cell Phone Mode on page 63	02 (Enable)	02 (Enable)	02 (Enable)	02 (Enable)	02 (Enable)	02 (Enable)
Cell Mode Percent on page 64	00 (Very Low)	00 (Very Low)	00 (Very Low)	00 (Very Low)	00 (Very Low)	00 (Very Low)
<b>Interface Related Features</b>						
Maximum Host-Transmitted Message Length on page 69	000 (no gen. limit imposed)	000 (no gen. limit imposed)	000 (no gen. limit imposed)	000 (no gen. limit imposed)	000 (no gen. limit imposed)	000 (no gen. limit imposed)
Ignore Host Commands on page 70	00 (don't ignore)	00 (don't ignore)	00 (don't ignore)	00 (don't ignore)	00 (don't ignore)	00 (don't ignore)
USB Power Compliance on page 71	01 (enable)	01 (enable)	01 (enable)	01 (enable)	01 (enable)	00 (disable)
USB Keyboard Country Mode on page 72	00 (USA)			00 (USA)		
USB Keyboard Caps Lock State on page 75	00 (caps lock OFF)			00 (caps lock OFF)		
USB Keyboard Send Control Characters on page 76	00 (disable)			00 (disable)		
USB Keyboard Intercharacter Delay on page 77	01 (10ms)			01 (10ms)		
USB Keyboard Additional Interface Options on page 78	40 (Rev D)	00	00	40 (Rev D)	40 (Rev D)/00	46

Feature	Default Master	RS-232	RS-232 Wincor-Nixdorf	Keyboard	USB COM / USB TEC	USB OEM
USB OEM Scanner Device Type on page 79	00 (table top)					00 (table top)
USB OEM Additional Interface Options on page 80	00 (disabled upon enumeration)					00 (disabled upon enumeration)
RS-232 Baud Rate on page 81	01 (9600)	01 (9600)	01 (9600)		01 (9600)	
RS-232 Number of Data Bits on page 83	01 (8 data bits)	01 (8 data bits)	01 (8 data bits)		01 (8 data bits)	
RS-232 Number of Stop Bits on page 83	00 (1 stop bit)	00 (1 stop bit)	00 (1 stop bit)		00 (1 stop bit)	
RS-232 Parity on page 84	00 (none)	00 (none)	02 (odd)		00 (none)	
RS-232 Hardware Control on page 85	00 (disable)	00 (disable)	01 (enable CTS flow control)		00 (disable)	
RS-232 Intercharacter Delay on page 86	00 (no delay)	00 (no delay)	00 (no delay)		00 (no delay)	
RS-232 Software Flow Control on page 87	00 (disable)	00 (disable)	00 (disable)		00 (disable)	
RS-232 Beep on ASCII BEL on page 88	00 (disable)	00 (disable)	00 (disable)		00 (disable)	
Beep on Not on File on page 88	01 (low vol)	01 (low vol)	01 (low vol)		01 (low vol)	01 (low vol)
ACK NAK Enable on page 89	00 (disable)	00 (disable)	00 (disable)		00 (disable)	
RS-232 ACK Character on page 90	06 (ACK)	06 (ACK)	06 (ACK)		06 (ACK)	
RS-232 NAK Character on page 91	15 (NAK)	15 (NAK)	15 (NAK)		15 (NAK)	
RS-232 Retry on ACK NAK Timeout on page 92	01 (enable)	01 (enable)	01 (enable)		01 (enable)	
RS-232 ACK NAK Timeout Value on page 93	01 (200ms)	01 (200ms)	01 (200ms)		01 (200ms)	
RS-232 ACK NAK Retry Count on page 94	03 (3 retries)	03 (3 retries)	03 (3 retries)		03 (3 retries)	
RS-232 ACK NAK Error Handling on page 95	00 (ignore)	00 (ignore)	00 (ignore)		00 (ignore)	
RS-232 Indicate Transmission Failure on page 96	01 (enable)	01 (enable)	01 (enable)		01 (enable)	
<b>Data Editing</b>						
Global Prefix on page 99	00 (no prefix)	00 (no prefix)	00 (no prefix)	00 (no prefix)	00 (no prefix)	00 (no prefix)

Feature	Default Master	RS-232	RS-232 Wincor-Nixdorf	Keyboard	USB COM / USB TEC	USB OEM
Global Suffix on page 100	0D00 (CR)	0D00 (CR)	0D00 (CR)	0D00 (CR)	0D00 (CR)	0D00 (CR)
AIM ID on page 101	00 (disable)	00 (disable)	00 (disable)	00 (disable)	00 (disable)	
Label ID on page 102	01 (Enable as prefix)	01 (Enable as prefix)	01 (Enable as prefix)	01 (Enable as prefix)	01 (Enable as prefix)	
Global Mid-Label ID on page 113	00 (no mid-label ID)	00 (no mid-label ID)	00 (no mid-label ID)	00 (no mid-label ID)	00 (no mid-label ID)	
Case Conversion on page 114	00 (no case convers'n)	00 (no case convers'n)	00 (no case convers'n)	00 (no case convers'n)	00 (no case convers'n)	00 (no case convers'n)
Character Conversion on page 115	FFFFFFFF FFFFFF (no char. convers'n)	FFFFFFFF FFFFFFFF (no char. convers'n)	FFFFFFFF FFFFFFFF (no char. convers'n)	FFFFFFFF FFFFFFFF (no char. convers'n)	FFFFFFFF FFFFFFFF (no char. convers'n)	FFFFFFFF FFFFFF (no char. convers'n)
<b>1D Symbology Programming</b>						
Coupon Control Enable on page 117	04 (Databar coupon label priority)	04 (Databar coupon label priority)	04 (Databar coupon label priority)	04 (Databar coupon label priority)	04 (Databar coupon label priority)	04 (Databar coupon label priority)
Coupon Label Priority Timer on page 119	0.2 Sec.	0.2 Sec.	0.2 Sec.	0.2 Sec.	0.2 Sec.	0.2 Sec.
UPC-A Enable on page 120	01 (enable)	01 (enable)	01 (enable)	01 (enable)	01 (enable)	01 (enable)
UPC-A Number System Character Transmission on page 121	01 (enable)	01 (enable)	01 (enable)	01 (enable)	01 (enable)	01 (enable)
UPC-A Check Character Transmission on page 122	01 (enable)	01 (enable)	01 (enable)	01 (enable)	01 (enable)	01 (enable)
UPC-A Minimum Read on page 123	01 (1 read)	01 (1 read)	01 (1 read)	01 (1 read)	01 (1 read)	01 (1 read)
Expand UPC-A to EAN-13 on page 124	00 (disable)	00 (disable)	01 (enable)	00 (disable)	00 (disable)	00 (disable)
UPC-E Enable on page 125	01 (enable)	01 (enable)	01 (enable)	01 (enable)	01 (enable)	01 (enable)
UPC-E Number System Character Transmission on page 126	01 (enable)	01 (enable)	01 (enable)	01 (enable)	01 (enable)	01 (enable)
UPC-E Check Character Transmission on page 127	01 (enable)	01 (enable)	00 (disable)	01 (enable)	01 (enable)	01 (enable)
Expand UPC-E to UPC-A on page 128	00 (disable)	00 (disable)	00 (disable)	00 (disable)	00 (disable)	00 (disable)
Expand UPC-E to EAN-13 on page 129	00 (disable)	00 (disable)	00 (disable)	00 (disable)	00 (disable)	00 (disable)
UPC-E Minimum Read on page 130	01 (1 read)	01 (1 read)	01 (1 read)	01 (1 read)	01 (1 read)	01 (1 read)



Feature	Default Master	RS-232	RS-232 Wincor-Nixdorf	Keyboard	USB COM / USB TEC	USB OEM
EAN-13 on page 131	01 (enable)	01 (enable)	01 (enable)	01 (enable)	01 (enable)	01 (enable)
EAN-13 First Character Transmission on page 132	01 (enable)	01 (enable)	01 (enable)	01 (enable)	01 (enable)	01 (enable)
EAN-13 Check Character Transmission on page 133	01 (enable)	01 (enable)	01 (enable)	01 (enable)	01 (enable)	01 (enable)
EAN-13 ISBN Conversion Enable on page 134	00 (disable)	00 (disable)	00 (disable)	00 (disable)	00 (disable)	00 (disable)
EAN-13 Minimum Read on page 135	01 (1 read)	01 (1 read)	01 (1 read)	01 (1 read)	01 (1 read)	01 (1 read)
EAN-8 on page 136	01 (enable)	01 (enable)	01 (enable)	01 (enable)	01 (enable)	01 (enable)
EAN-8 Check Character Transmission on page 137	01 (enable)	01 (enable)	01 (enable)	01 (enable)	01 (enable)	01 (enable)
Expand EAN-8 to EAN-13 on page 138	00 (disable)	00 (disable)	00 (disable)	00 (disable)	00 (disable)	00 (disable)
EAN-8 Minimum Read on page 139	01 (1 read)	01 (1 read)	01 (1 read)	01 (1 read)	01 (1 read)	01 (1 read)
EAN-8 Guard Insertion on page 140	00 (disable)	00 (disable)	00 (disable)	00 (disable)	00 (disable)	00 (disable)
EAN-8 Guard Substitution on page 141	00 (disable)	00 (disable)	00 (disable)	00 (disable)	00 (disable)	00 (disable)
EAN-8/Jan-8 Both Guards Substitution on page 142	00 (disable)	00 (disable)	00 (disable)	00 (disable)	00 (disable)	00 (disable)
EAN-8 Stitch Exact Label Halves on page 143	00 (disable)	00 (disable)	00 (disable)	00 (disable)	00 (disable)	00 (disable)
EAN-8 Stitch Unlike Label Halves on page 144	00 (disable)	00 (disable)	00 (disable)	00 (disable)	00 (disable)	00 (disable)
EAN-8 Minimum Segment Length on page 145	08	08	08	08	08	08
EAN-8 Decoding Levels on page 147	01 (very conservative)	01 (very conservative)	01 (very conservative)	01 (very conservative)	01 (very conservative)	01 (very conservative)
In-Store Printed Label Minimum Read on page 149	01 (1 read)	01 (1 read)	01 (1 read)	01 (1 read)	01 (1 read)	01 (1 read)
UPC/EAN Correlation on page 150	00 (disable)	00 (disable)	00 (disable)	00 (disable)	00 (disable)	00 (disable)
UPC/EAN Guard Insertion on page 151	00 (disable)	00 (disable)	00 (disable)	00 (disable)	00 (disable)	00 (disable)
UPC/EAN Stitch Exact Label Halves on page 152	00 (disable)	00 (disable)	00 (disable)	00 (disable)	00 (disable)	00 (disable)

Feature	Default Master	RS-232	RS-232 Wincor-Nixdorf	Keyboard	USB COM / USB TEC	USB OEM
UPC/EAN Stitch Unlike Label Halves on page 153	00 (disable)	00 (disable)	00 (disable)	00 (disable)	00 (disable)	00 (disable)
UPC/EAN Minimum Segment Length on page 154	05 (5 char.)	05 (5 char.)	05 (5 char.)	05 (5 char.)	05 (5 char.)	05 (5 char.)
Price Weight Check on page 156	00 (disable)	00 (disable)	00 (disable)	00 (disable)	00 (disable)	00 (disable)
Enable EAN Two Label on page 158	00 (disable)	00 (disable)	00 (disable)	00 (disable)	00 (disable)	00 (disable)
EAN Two Label Minimum Read on page 159	01 (1 read)	01 (1 read)	01 (1 read)	01 (1 read)	01 (1 read)	01 (1 read)
EAN Two Label Combined Transmission on page 160	00 (disable)	00 (disable)	00 (disable)	00 (disable)	00 (disable)	
Add-ons on page 161	disable all	disable all	disable all	disable all	disable all	disable all
P2 Add-on Minimum Read on page 162	02 (2 reads)	02 (2 reads)	02 (2 reads)	02 (2 reads)	02 (2 reads)	02 (2 reads)
P5 Add-on Minimum Read on page 165	01 (1 read)	01 (1 read)	01 (1 read)	01 (1 read)	01 (1 read)	01 (1 read)
UPC/EAN Composites on page 168	00 (disable)	00 (disable)	00 (disable)	00 (disable)	00 (disable)	00 (disable)
GTIN on page 169	00 (disable)	00 (disable)	00 (disable)	00 (disable)	00 (disable)	
DataBar Omnidirectional Enable on page 170	00 (disable)	00 (disable)	00 (disable)	00 (disable)	00 (disable)	00 (disable)
DataBar Omnidirectional/EAN-128 Emulation on page 171	00 (disable)	00 (disable)	00 (disable)	00 (disable)	00 (disable)	00 (disable)
DataBar Omnidirectional 2D Component Enable on page 172	00 (disable)	00 (disable)	00 (disable)	00 (disable)	00 (disable)	00 (disable)
DataBar Omnidirectional Minimum Read on page 173	01 (1 read)	01 (1 read)	01 (1 read)	01 (1 read)	01 (1 read)	01 (1 read)
DataBar Omnidirectional Double Read Timeout on page 174	2.5 Sec.	2.5 Sec.	2.5 Sec.	2.5 Sec.	2.5 Sec.	2.5 Sec.
DataBar Limited Enable on page 175	00 (disable)	00 (disable)	00 (disable)	00 (disable)	00 (disable)	00 (disable)
DataBar Limited Minimum Read on page 176	01 (1 read)	01 (1 read)	01 (1 read)	01 (1 read)	01 (1 read)	01 (1 read)
DataBar Limited 2D Component Enable on page 177	00 (disable)	00 (disable)	00 (disable)	00 (disable)	00 (disable)	00 (disable)
DataBar Limited EAN128 Emulation Enable on page 178	00 (disable)	00 (disable)	00 (disable)	00 (disable)	00 (disable)	00 (disable)

Feature	Default Master	RS-232	RS-232 Wincor-Nixdorf	Keyboard	USB COM / USB TEC	USB OEM
DataBar Expanded on page 179	00 (disable)	00 (disable)	00 (disable)	00 (disable)	00 (disable)	00 (disable)
DataBar Expanded EAN-128 Emulation on page 180	00 (disable)	00 (disable)	00 (disable)	00 (disable)	00 (disable)	00 (disable)
DataBar Expanded 2D Component Enable on page 181	00 (disable)	00 (disable)	00 (disable)	00 (disable)	00 (disable)	00 (disable)
DataBar Expanded Minimum Read on page 182	01 (1 read)	01 (1 read)	01 (1 read)	01 (1 read)	01 (1 read)	01 (1 read)
DataBar Expanded Length Control on page 183	00 (variable)	00 (variable)	00 (variable)	00 (variable)	00 (variable)	00 (variable)
DataBar Expanded Length 1 on page 184	01	01	01	01	01	01
DataBar Expanded Length 2 on page 185	4A	4A	4A	4A	4A	4A
DataBar Expanded Reverse Retry on page 186	00 (disable)	00 (disable)	00 (disable)	00 (disable)	00 (disable)	00 (disable)
Code 39 on page 187	01 (enable)	01 (enable)	01 (enable)	01 (enable)	01 (enable)	01 (enable)
Code 39 Start Stop Character Transmission on page 188	00 (disable)	00 (disable)	00 (disable)	00 (disable)	00 (disable)	00 (disable)
Code 39 Check Character Calculation on page 189	00 (disable)	00 (disable)	00 (disable)	00 (disable)	00 (disable)	00 (disable)
Code 39 Check Character Transmission on page 190	01 (enable)	01 (enable)	01 (enable)	01 (enable)	01 (enable)	01 (enable)
Code 39 Full ASCII on page 191	00 (disable)	00 (disable)	00 (disable)	00 (disable)	00 (disable)	00 (disable)
Code 39 Minimum Read on page 192	01 (1 read)	01 (1 read)	01 (1 read)	01 (1 read)	01 (1 read)	01 (1 read)
Code 39 Length Control on page 193	00 (variable)	00 (variable)	00 (variable)	00 (variable)	00 (variable)	00 (variable)
Code 39 Length 1 on page 194	02	02	02	02	02	02
Code 39 Length 2 on page 195	32	32	32	32	32	32
Code 39 Stitching on page 196	01 (enable)	01 (enable)	01 (enable)	01 (enable)	01 (enable)	01 (enable)
Code 39 Require Margins on page 197	00 (disable)	00 (disable)	00 (disable)	00 (disable)	00 (disable)	00 (disable)
Code 32 Italian Pharmacode on page 198	00 (disable)	00 (disable)	00 (disable)	00 (disable)	00 (disable)	00 (disable)
Code 32 Start Stop Character Transmission on page 199	00 (disable)	00 (disable)	00 (disable)	00 (disable)	00 (disable)	00 (disable)

Feature	Default Master	RS-232	RS-232 Wincor-Nixdorf	Keyboard	USB COM / USB TEC	USB OEM
Code 32 Check Character Transmission on page 200	00 (disable)	00 (disable)	00 (disable)	00 (disable)	00 (disable)	
Code 128 on page 201	01 (enable)	01 (enable)	01 (enable)	01 (enable)	01 (enable)	01 (enable)
Code 128 Transmit Function Characters on page 202	00 (disable)	00 (disable)	00 (disable)	00 (disable)	00 (disable)	00 (disable)
Expand Code128 to Code 39 on page 203	00 (disable)	00 (disable)	00 (disable)	00 (disable)	00 (disable)	00 (disable)
Code 128 Minimum Read on page 204	01 (1 read)	01 (1 read)	01 (1 read)	01 (1 read)	01 (1 read)	01 (1 read)
Code 128 Length Control on page 205	00 (variable)	00 (variable)	00 (variable)	00 (variable)	00 (variable)	00 (variable)
Code 128 Length 1 on page 206	01	01	01	01	01	01
Code 128 Length 2 on page 207	50	50	50	50	50	50
Code 128 Stitching on page 208	01 (enable)	01 (enable)	01 (enable)	01 (enable)	01 (enable)	01 (enable)
EAN-128 on page 209	00 (disable)	00 (disable)	00 (disable)	00 (disable)	00 (disable)	00 (disable)
Interleaved 2 of 5 (I 2 OF 5) on page 210	00 (disable)	00 (disable)	00 (disable)	00 (disable)	00 (disable)	00 (disable)
I 2 of 5 Check Character Calculation on page 211	00 (disable)	00 (disable)	00 (disable)	00 (disable)	00 (disable)	00 (disable)
I 2 of 5 Check Character Transmission on page 212	01 (enable)	01 (enable)	01 (enable)	01 (enable)	01 (enable)	01 (enable)
I 2 of 5 Minimum Read on page 213	01 (1 read)	01 (1 read)	01 (1 read)	01 (1 read)	01 (1 read)	01 (1 read)
I 2 of 5 Length Control on page 214	00 (variable)	00 (variable)	00 (variable)	00 (variable)	00 (variable)	00 (variable)
I 2 of 5 Length 1 on page 215	06	06	06	06	06	06
I 2 of 5 Length 2 on page 216	32	32	32	32	32	32
Codabar on page 217	00 (disable)	00 (disable)	00 (disable)	00 (disable)	00 (disable)	00 (disable)
Codabar Start Stop Character Transmission on page 218	01 (enable)	01 (enable)	01 (enable)	01 (enable)	01 (enable)	01 (enable)
Codabar Start Stop Character Set on page 219	03 (abcd/abcd)	03 (abcd/abcd)	03 (abcd/abcd)	03 (abcd/abcd)	03 (abcd/abcd)	03 (abcd/abcd)
Codabar Start Stop Character Match on page 220	00 (disable)	00 (disable)	00 (disable)	00 (disable)	00 (disable)	00 (disable)
Codabar Check Character Calculation on page 221	00 (disable)	00 (disable)	00 (disable)	00 (disable)	00 (disable)	00 (disable)

Feature	Default Master	RS-232	RS-232 Wincor-Nixdorf	Keyboard	USB COM / USB TEC	USB OEM
Codabar Check Character Transmission on page 222	01 (enable)	01 (enable)	01 (enable)	01 (enable)	01 (enable)	01 (enable)
Codabar Minimum Read on page 223	01 (1 read)	01 (1 read)	01 (1 read)	01 (1 read)	01 (1 read)	01 (1 read)
Codabar Length Control on page 224	00 (disable)	00 (disable)	00 (disable)	00 (disable)	00 (disable)	00 (disable)
Codabar Length Control on page 224	00 (variable)	00 (variable)	00 (variable)	00 (variable)	00 (variable)	00 (variable)
Codabar Length 1 on page 225	03	03	03	03	03	03
Codabar Length 2 on page 226	32	32	32	32	32	32
Codabar Require Margins on page 227	00 (disable)	00 (disable)	00 (disable)	00 (disable)	00 (disable)	00 (disable)
Code 93 on page 228	00 (disable)	00 (disable)	00 (disable)	00 (disable)	00 (disable)	00 (disable)
Code 93 Minimum Read on page 229	01 (1 read)	01 (1 read)	01 (1 read)	01 (1 read)	01 (1 read)	01 (1 read)
Code 93 Length Control on page 230	00 (disable)	00 (disable)	00 (disable)	00 (disable)	00 (disable)	00 (disable)
Code 93 Length Control on page 230	00 (variable)	00 (variable)	00 (variable)	00 (variable)	00 (variable)	00 (variable)
Code 93 Length 1 on page 231	01	01	01	01	01	01
Code 93 Length 2 on page 232	32	32	32	32	32	32
MSI on page 233	00 (disable)	00 (disable)	00 (disable)	00 (disable)	00 (disable)	
MSI Check Character Calculation on page 234	01 (enable)	01 (enable)	01 (enable)	01 (enable)	01 (enable)	
MSI Number of Check Characters on page 235	00 (1 char)	00 (1 char)	00 (1 char)	00 (1 char)	00 (1 char)	
MSI Check Character Transmission on page 236	01 (enable)	01 (enable)	01 (enable)	01 (enable)	01 (enable)	
MSI Minimum Read on page 237	01 (1 read)	01 (1 read)	01 (1 read)	01 (1 read)	01 (1 read)	
MSI Length Control on page 238	00 (variable)	00 (variable)	00 (variable)	00 (variable)	00 (variable)	
MSI Length 1 on page 239	04	04	04	04	04	
MSI Length 2 on page 240	10	10	10	10	10	
Standard 2 of 5 on page 241	00 (disable)	00 (disable)	00 (disable)	00 (disable)	00 (disable)	00 (disable)

Feature	Default Master	RS-232	RS-232 Wincor-Nixdorf	Keyboard	USB COM / USB TEC	USB OEM
Standard 2 of 5 Check Character Calculation on page 242	00 (disable)	00 (disable)	00 (disable)	00 (disable)	00 (disable)	00 (disable)
Standard 2 of 5 Check Character Transmission on page 243	01 (enable)	01 (enable)	01 (enable)	01 (enable)	01 (enable)	01 (enable)
Standard 2 of 5 Minimum Read on page 244	01 (1 read)	01 (1 read)	01 (1 read)	01 (1 read)	01 (1 read)	01 (1 read)
Standard 2 of 5 Correlation on page 245	00 (disable)	00 (disable)	00 (disable)	00 (disable)	00 (disable)	00 (disable)
Standard 2 of 5 Length Control on page 246	00 (variable)	00 (variable)	00 (variable)	00 (variable)	00 (variable)	00 (variable)
Standard 2 of 5 Length 1 on page 247	08	08	08	08	08	08
Standard 2 of 5 Length 2 on page 248	32	32	32	32	32	32
<b>2D Symbology Programming</b>						
Data Matrix on page 250	00 (disable)	00 (disable)	00 (disable)	00 (disable)	00 (disable)	00 (disable)
Data Matrix Length Control on page 251	00 (variable)	00 (variable)	00 (variable)	00 (variable)	00 (variable)	00 (variable)
Set Data Matrix Length 1 on page 252	0001	0001	0001	0001	0001	0001
Set Data Matrix Length 2 on page 252	0320	0320	0320	0320	0320	0320
GS1 Datamatrix Enable on page 253	00 (transmit as std Data-matrix label)	00 (transmit as std Data-matrix label)	01 (transmit as GS1 Data-matrix label)	00 (transmit as std Data-matrix label)	00 (transmit as std Data-matrix label)	00 (transmit as std Data-matrix label)
PDF 417 Enable on page 254	01 (enable)	01 (enable)	01 (enable)	01 (enable)	01 (enable)	01 (enable)
PDF 417 Length Control on page 255	00 (variable)	00 (variable)	00 (variable)	00 (variable)	00 (variable)	00 (variable)
Set PDF 417 Length 1 on page 256	0001	0001	0001	0001	0001	0001
Set PDF 417 Length 2 on page 256	0A96	0A96	0A96	0A96	0A96	0A96
PDF 417 Read Option on page 257	00 (none)	00 (none)	00 (none)	00 (none)	00 (none)	00 (none)
Micro PDF 417 on page 258	00 (disable)	00 (disable)	00 (disable)	00 (disable)	00 (disable)	00 (disable)
Micro PDF 417 Length Control on page 259	00 (variable)	00 (variable)	00 (variable)	00 (variable)	00 (variable)	00 (variable)

Feature	Default Master	RS-232	RS-232 Wincor-Nixdorf	Keyboard	USB COM / USB TEC	USB OEM
Set Micro PDF 417 Length 1 on page 260	0001	0001	0001	0001	0001	0001
Set Micro PDF 417 Length 2 on page 260	016E	016E	016E	016E	016E	016E
Micro PDF 417 128 Emulation on page 261	00 (Micro PDF 417 AIM ID & label type)	00 (Micro PDF 417 AIM ID & label type)	00 (Micro PDF 417 AIM ID & label type)	00 (Micro PDF 417 AIM ID & label type)	00 (Micro PDF 417 AIM ID & label type)	00 (Micro PDF 417 AIM ID & label type)
QR Code on page 262	00 (disable)	00 (disable)	00 (disable)	00 (disable)	00 (disable)	00 (disable)
QR Code Length Control on page 263	00 (variable)	00 (variable)	00 (variable)	00 (variable)	00 (variable)	00 (variable)
Set QR Code Length 1 on page 264	0001	0001	0001	0001	0001	0001
Set QR Code Length 2 on page 264	0A96	0A96	0A96	0A96	0A96	0A96
QR Code URL Link Enable on page 265	00 (disable)	00 (disable)	00 (disable)	00 (disable)	00 (disable)	00 (disable)
GS1 QR Code Enable on page 266	00 (transmit as std QR Code label)	00 (transmit as std QR Code label)	01 (transmit as GS1 QR Code label)	00 (transmit as std QR Code label)	00 (transmit as std QR Code label)	00 (transmit as std QR Code label)
Micro QR Code on page 267	00 (disable)	00 (disable)	00 (disable)	00 (disable)	00 (disable)	00 (disable)
Micro QR Code Length Control on page 268	00 (variable)	00 (variable)	00 (variable)	00 (variable)	00 (variable)	00 (variable)
Set Micro QR Code Length 1 on page 269	0001	0001	0001	0001	0001	0001
Set Micro QR Code Length 2 on page 269	0E74	0E74	0E74	0E74	0E74	0E74
Aztec Code on page 270	00 (disable)	00 (disable)	00 (disable)	00 (disable)	00 (disable)	00 (disable)
Aztec Length Control on page 271	00 (variable)	00 (variable)	00 (variable)	00 (variable)	00 (variable)	00 (variable)
Set Aztec Length 1 on page 272	0001	0001	0001	0001	0001	0001
Set Aztec Length 2 on page 272	0E74	0E74	0E74	0E74	0E74	0E74
Han Xin Code on page 273	00 (disable)	00 (disable)	00 (disable)	00 (disable)	00 (disable)	00 (disable)
<b>Postal Code Symbology Programming</b>						
Postnet on page 274	00 (disable)	00 (disable)	00 (disable)	00 (disable)	00 (disable)	00 (disable)

Feature	Default Master	RS-232	RS-232 Wincor-Nixdorf	Keyboard	USB COM / USB TEC	USB OEM
Planet Code on page 275	00 (disable)	00 (disable)	00 (disable)	00 (disable)	00 (disable)	00 (disable)
Royal Mail on page 276	00 (disable)	00 (disable)	00 (disable)	00 (disable)	00 (disable)	00 (disable)
Kix on page 277	00 (disable)	00 (disable)	00 (disable)	00 (disable)	00 (disable)	00 (disable)
Australia Post on page 278	00 (disable)	00 (disable)	00 (disable)	00 (disable)	00 (disable)	00 (disable)
Japan Post on page 279	00 (disable)	00 (disable)	00 (disable)	00 (disable)	00 (disable)	00 (disable)
IMB on page 280	00 (disable)	00 (disable)	00 (disable)	00 (disable)	00 (disable)	00 (disable)
Sweden Post on page 281	00 (disable)	00 (disable)	00 (disable)	00 (disable)	00 (disable)	00 (disable)
Portugal Post on page 282	00 (disable)	00 (disable)	00 (disable)	00 (disable)	00 (disable)	00 (disable)





# Appendix E

## Keyboard Function Key Mappings

### USB Function Key Usage Map

ASCII	Key value	Usage Name	Modifier/ Scancode
02	STX	F11	00h 44h
03	ETX	F12	00h 45h
04	EOT	GUI right Make	80h 00h
05	ENQ	GUI right Break	00h 00h
06	ACK	CTRL right Make	10h 00h
07	BEL	CTRL right Break	00h 00h
08	BS	BS	00h 2Ah
09	HT	TAB right	00h 2Bh
0A	LF	RIGHT arrow (inner keypad)	00h 4Fh
0B	VT	TAB left	02h 2Bh
0C	FF	Enter (right keypad)	00h 58h
0D	CR	CR	00h 28h
0E	SO	INSERT (inner keypad)	00h 49h
0F	SI	PAGE UP (inner keypad)	00h 4Bh
10	DLE	PAGE DOWN (inner keypad)	00h 4Eh
11	DC1	HOME (inner keypad)	00h 4Ah
12	DC2	LEFT arrow (inner keypad)	00h 50h
13	DC3	DOWN arrow (inner keypad)	00h 51h
14	DC4	UP arrow (inner keypad)	00h 52h
15	NAK	F6	00h 3Fh
16	SYN	F1	00h 3Ah
17	ETB	F2	00h 3Bh
18	CAN	F3	00h 3Ch
19	EM	F4	00h 3Dh
1A	SUB	F5	00h 3Eh
1B	ESC	ESC	00h 29h
1C	FS	F7	00h 40h
1D	GS	F8	00h 41h
1E	RS	F9	00h 42h
1F	US	F10	00h 43h

The following keys can be optionally configured to correspond to the Rev C version of this function table. See [USB Keyboard Additional Interface Options](#) on page 78 to set this feature.

ASCII	Key value	Usage Name	Modifier/Scancode
02	STX	F11	00h 44h
03	ETX	F12	00h 45h
04	EOT	GUI right Make	80h 00h
05	ENQ	GUI right Break	00h 00h

## Scanset 1 Function Key Map

ASCII (hex)	ASCII code	Key	Scancode
02	STX	ALT left Make	38h
03	ETX	ALT left Break	B8h
04	EOT	CTRL left Make	1Dh
05	ENQ	CTRL left Break	9Dh
06	ACK	CTRL right Make	E0h 1Dh
07	BEL	CTRL right Break	E0h 9Dh
08	BS	BS	0Eh
09	HT	TAB right	0Fh
0A	LF	RIGHT arrow (inner keypad)	4Dh + E0
0B	VT	TAB left	0Fh + S
0C	FF	Enter (inner keypad)	1Ch + E0
0D	CR	CR	1Ch
0E	SO	INSERT (inner keypad)	52h + E0
0F	SI	PAGE UP (inner keypad)	49h + E0
10	DLE	PAGE DOWN (inner keypad)	51h + E0
11	DC1	HOME (inner keypad)	47h + E0
12	DC2	LEFT arrow (inner keypad)	4Bh + E0
13	DC3	DOWN arrow (inner keypad)	50h + E0
14	DC4	UP arrow (inner keypad)	48h + E0

## Scanset 2 Function Key Map

ASCII (hex)	ASCII code	Key	Scancode
02	STX	ALT left Make	11h
03	ETX	ALT left Break	F0h 11h
04	EOT	CTRL left Make	14h
05	ENQ	CTRL left Break	F0h 14h
06	ACK	CTRL right Make	E0h 14h
07	BEL	CTRL right Break	E0h F0h 14h
08	BS	BS	66h
09	HT	TAB right	0Dh
0A	LF	RIGHT arrow (inner keypad)	74h + E0
0B	VT	TAB left	0Dh + S
0C	FF	Enter (right keypad)	5Ah + E0
0D	CR	CR	5Ah
0E	SO	INSERT (inner keypad)	70h + E0
0F	SI	PAGE UP (inner keypad)	7Dh + E0
10	DLE	PAGE DOWN (inner keypad)	7Ah + E0
11	DC1	HOME (inner keypad)	6Ch + E0
12	DC2	LEFT arrow (inner keypad)	6Bh + E0
13	DC3	DOWN arrow (inner keypad)	72h + E0
14	DC4	UP arrow (inner keypad)	75h + E0
15	NAK	F6	0Bh
16	SYN	F1	05h
17	ETB	F2	06h
18	CAN	F3	04h
19	EM	F4	0Ch
1A	SUB	F5	03h
1B	ESC	ESC	76h

1C	FS	F7	83h
1D	GS	F8	0Ah
1E	RS	F9	01h
1F	US	F10	09h

### Scanset 3, 102-Key Function Key Map

ASCII (hex)	ASCII code	Key	Scancode
02	STX	ALT left Make	19h
03	ETX	ALT left Break	F0h 19h
04	EOT	CTRL left Make	11h
05	ENQ	CTRL left Break	F0h 11h
06	ACK	CTRL right Make	58h
07	BEL	CTRL right Break	F0h 58h
08	BS	BS	66h
09	HT	TAB right	0Dh
0A	LF	RIGHT arrow (inner keypad)	6Ah
0B	VT	TAB left	0Dh + S
0C	FF	Enter (inner keypad)	79h
0D	CR	CR	5Ah
0E	SO	INSERT (inner keypad)	67h
0F	SI	PAGE UP (inner keypad)	6Fh
10	DLE	PAGE DOWN (inner keypad)	6Dh
11	DC1	HOME (inner keypad)	6Eh
12	DC2	LEFT arrow (inner keypad)	61h
13	DC3	DOWN arrow (inner keypad)	60h
14	DC4	UP arrow (inner keypad)	63h
15	NAK	F6	2Fh
16	SYN	F1	07h
17	ETB	F2	0Fh
18	CAN	F3	17h
19	EM	F4	1Fh
1A	SUB	F5	27h
1B	ESC	ESC	08h
1C	FS	F7	37h
1D	GS	F8	3Fh
1E	RS	F9	47h
1F	US	F10	4Fh

## Scanset 3 122-Key Function Key Map

ASCII (hex)	ASCII code	Key	Scancode
02	STX	ALT left Make	19h
03	ETX	ALT left Break	F0h 19h
04	EOT	CTRL left (RESET) Make only	11h
05	ENQ	CTRL left (RESET) Make/Break	11h F0h 11h
06	ACK	ONLINE Enter Make only	58h
07	BEL	ONLINE Enter Make/Break	58h F0h 58h
08	BS	BS	66h
09	HT	TAB right	0Dh
0A	LF	RIGHT arrow (inner keypad)	6Ah
0B	VT	TAB left	0Dh + S
0C	FF	CR (FIELD EXIT) Make only	5Ah F0h 5Ah
0D	CR	CR (FIELD EXIT) Make/Break	5Ah
0E	SO	INSERT (inner keypad)	65h
0F	SI	FIELD +	79h
10	DLE	FIELD -	7Ch
11	DC1	HOME (inner keypad)	62h
12	DC2	LEFT arrow (inner keypad)	61h
13	DC3	DOWN arrow (inner keypad)	60h
14	DC4	UP arrow (inner keypad)	63h
15	NAK	F6	2Fh
16	SYN	F1	07h
17	ETB	F2	0Fh
18	CAN	F3	17h
19	EM	F4	1Fh
1A	SUB	F5	27h
1B	ESC	ESC	08h
1C	FS	F7	37h
1D	GS	F8	3Fh
1E	RS	F9	47h
1F	US	F10	4Fh

## Japanese DOS Function Key Map

ASCII value	ASCII code	Key	Scancode
02h	STX	ALT left Make	31h
03h	ETX	ALT left Break	B1h
04h	EOT	CTRL left Make	41h
05h	ENQ	CTRL left Break	C1h
06h	ACK	CTRL right Make	41h
07h	BEL	CTRL right Break	C1h
08h	BS	BS	3Eh
09h	HT	TAB right	3Ch
0Ah	LF	RIGHT arrow (inner keypad)	4Dh
0Bh	VT	TAB left	3Ch + 5
0Ch	FF	Enter (right keypad)	60h
0Dh	CR	CR	3Bh
0Eh	SO	INSERT (inner keypad)	52h
0Fh	SI	PAGE UP (inner keypad)	49h
10h	DLE	PAGE DOWN (inner keypad)	51h
11h	DC1	HOME (inner keypad)	4Ch
12h	DC2	LEFT arrow (inner keypad)	4Bh
13h	DC3	DOWN arrow (inner keypad)	4Ah
14h	DC4	UP arrow (inner keypad)	4Eh
15h	NAK	F6	6Dh
16h	SYN	F1	68h
17h	ETB	F2	69h
18h	CAN	F3	6Ah
19h	EM	F4	6Bh
1Ah	SUB	F5	6Ch
1Bh	ESC	ESC	3Dh
1Ch	FS	F7	6Eh
1Dh	GS	F8	6Fh
1Eh	RS	F9	70h
1Fh	US	F10	71h

## NEC 9801-Key Function Key Map

ASCII value	ASCII code	Key	Scancode
00h	NUL	unused	n/a
01h	SOH	CR	1Ch
02h	STX	CAPS LOCK ON (make)	71h
03h	ETX	CAPS LOCK OFF (break)	F1h
04h	EOT	CTRL left Make	74h
05h	ENQ	CTRL left Break	F4h
06h	ACK	CTRL-C	60h
07h	BEL	n/a	n/a
08h	BS	BS	0Eh
09h	HT	TAB right	0Fh
0Ah	LF	RIGHT arrow (inner keypad)	3Ch
0Bh	VT	TAB left	0Fh + S
0Ch	FF	DELETE	39h
0Dh	CR	CR	1Ch
0Eh	SO	INSERT (inner keypad)	38h
0Fh	SI	KATAKANA LOCK ON (Make)	72h
10h	DLE	KATAKANA LOCK OFF (Break)	F2h
11h	DC1	HOME (inner keypad)	3Eh
12h	DC2	LEFT arrow (inner keypad)	3Bh
13h	DC3	DOWN arrow (inner keypad)	3Dh
14h	DC4	UP arrow (inner keypad)	3Ah
15h	NAK	F6	67h
16h	SYN	F1	62h
17h	ETB	F2	63h
18h	CAN	F3	64h
19h	EM	F4	65h
1Ah	SUB	F5	66h
1Bh	ESC	ESC	00h
1Ch	FS	F7	68h
1Dh	GS	F8	69h
1Eh	RS	F9	6Ah
1Fh	US	F10	6Bh



# Appendix F

## Host Commands

### Accepting RS-232 and USB COM Commands

The scanner responds to the following RS-232 and USB COM commands:

COMMAND	ASCII	HEX	COMMENT
Enable Scanner	E	0x45	
Disable Scanner	D	0x44	
Reset Scanner	R	0x52	
Not On File Indication	F	0x46	Long series of beeps
Beep Good Read Tone	B	0x42	Beeps if Good Read Beep is enabled
Force Good Read Tone	n/a	0x01	Beeps regardless of beep setting
Identification request	i	0x69	Returns long response <sup>a</sup>
Health request	h	0x68	Returns long response <sup>a</sup>
Status request	s	0x73	Returns long response <sup>a</sup>
Beep on ASCII BEL	!	0x07	Beeps if Beep on ASCII BEL is enabled

a. Call Tech Support for information.

If one of the above commands is received, the scanner will perform the steps indicated for the command. Host commands for other interfaces are also available. Contact Tech Support for more details.

Information about additional features can be found in "Service Port Mode" on page 14 and "Image Capture to the Host by Host Command" on page 48.



# Appendix G

## Sample Symbols

### 1D Symbol Samples

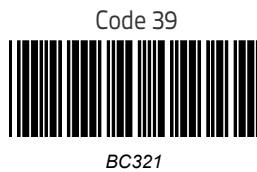
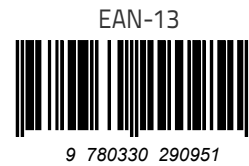
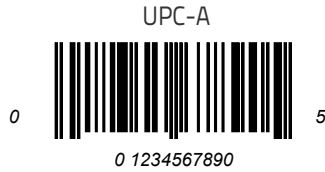



---

GS1 DataBar Omnidirectional



(01)00123456789012

Code 2 of 5

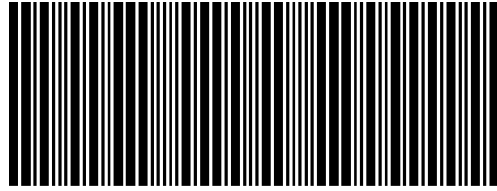

123456

GS1 DataBar Expanded



0100123456789050

GS1 DataBar Limited

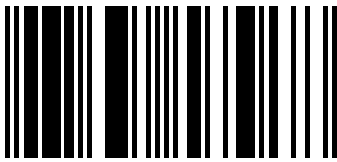

(01)16543210987654

## 2D Sample Symbols

PDF 417

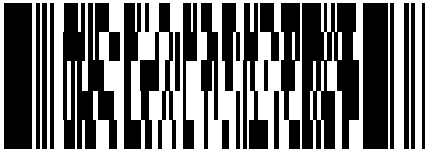

A12B3C

Micro PDF 417



BV17453

Datamatrix

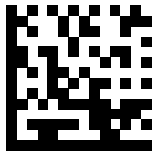

1314H17LL

QR Code



35900G9

Micro QR Code



ABCDEF

Aztec



This is an Aztec Code

---

## Composite Sample Symbols

GS1 DataBar Limited Composite

(17) 050923 (10) ABC123



(01) 0 4012345 67890 1

GS1 DataBar Truncated Composite

(17)050923(10)ABC123



(01) 09876543217899

# NOTES

## ASCII Character Set

The table on this page shows a set of ASCII characters and their corresponding Hex Values. The Hex Values in this table are needed for setting symbology-specific label identifiers, as well as enabling custom prefix and suffix characters.

ASCII Char.	Hex No.	ASCII Char.	Hex No.	ASCII Char.	Hex No.	ASCII Char.	Hex No.
NUL	00	SP	20	@	40	'	60
SOH	01	!	21	A	41	a	61
STX	02	"	22	B	42	b	62
ETX	03	#	23	C	43	c	63
EOT	04	\$	24	D	44	d	64
ENQ	05	%	25	E	45	e	65
ACK	06	&	26	F	46	f	66
BEL	07	'	27	G	47	g	67
BS	08	(	28	H	48	h	68
HT	09	)	29	I	49	i	69
LF	0A	*	2A	J	4A	j	6A
VT	0B	+	2B	K	4B	k	6B
FF	0C	,	2C	L	4C	l	6C
CR	0D	-	2D	M	4D	m	6D
SO	0E	.	2E	N	4E	n	6E
SI	0F	/	2F	O	4F	o	6F
DLE	10	0	30	P	50	p	70
DC1	11	1	31	Q	51	q	71
DC2	12	2	32	R	52	r	72
DC3	13	3	33	S	53	s	73
DC4	14	4	34	T	54	t	74
NAK	15	5	35	U	55	u	75
SYN	16	6	36	V	56	v	76
ETB	17	7	37	W	57	w	77
CAN	18	8	38	X	58	x	78
EM	19	9	39	Y	59	y	79
SUB	1A	:	3A	Z	5A	z	7A
ESC	1B	;	3B	[	5B	{	7B
FS	1C	<	3C	\	5C		7C
GS	1D	=	3D	]	5D	}	7D
RS	1E	>	3E	^	5E	~	7E
US	1F	?	3F	_	5F	DEL	7F



©2018–2019 Datalogic S.p.A. and/or its affiliates • All rights reserved. • Without limiting the rights under copyright, no part of this documentation may be reproduced, stored in or introduced into a retrieval system, or transmitted in any form or by any means, or for any purpose, without the express written permission of Datalogic S.p.A. and/or its affiliates • Datalogic and the Datalogic logo are registered trademarks of Datalogic S.p.A. in many countries, including the U.S. and the E.U.



[www.datalogic.com](http://www.datalogic.com)

**Datalogic S.r.l.**

Via S. Vitalino, 13 | 40012 Calderara di Reno | Bologna - Italy  
Tel. +39 051 3147011 | Fax +39 051 3147205

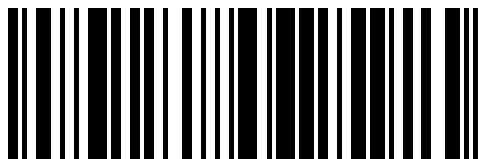

820108814

(Rev. A)

Mar 2019