

# QuickScan™ QD2590

## PRODUCT REFERENCE GUIDE



General Purpose Corded  
Area Imager Bar Code Reader

 **DATALOGIC**

**Datalogic S.r.l.**

Via S. Vitalino, 13  
40012 Calderara di Reno (BO)  
Italy  
Tel. +39 051 3147011  
Fax +39 051 3147205

**© 2021 Datalogic S.p.A. and /or its affiliates**

All rights reserved. Without limiting the rights under copyright, no part of this documentation may be reproduced, stored in or introduced into a retrieval system, or transmitted in any form or by any means, or for any purpose, without the express written permission of Datalogic S.p.A. and/or its affiliates.

Owners of Datalogic products are hereby granted a non-exclusive, revocable license to reproduce and transmit this documentation for the purchaser's own internal business purposes. Purchaser shall not remove or alter any proprietary notices, including copyright notices, contained in this documentation and shall ensure that all notices appear on any reproductions of the documentation.

Electronic versions of this document may be downloaded from the Datalogic website ([www.datalogic.com](http://www.datalogic.com)). If you visit our website and would like to make comments or suggestions about this or other Datalogic publications, please let us know via the "Contact" page.

**Disclaimer**

Datalogic has taken reasonable measures to provide information in this manual that is complete and accurate, however, Datalogic shall not be liable for technical or editorial errors or omissions contained herein, nor for incidental or consequential damages resulting from the use of this material. Datalogic reserves the right to change any specification at any time without prior notice.

**Trademarks**

Datalogic and the Datalogic logo are registered trademarks of Datalogic S.p.A. in many countries, including the U.S.A. and the E.U.

QuickScan is a trademark of Datalogic S.p.A. and/or its affiliates, registered in the U.S. The Bluetooth word mark and logos are owned by Bluetooth SIG, Inc. and any use of such marks by Datalogic S.p.A. and/or its affiliates is under license. All other trademarks and brands are property of their respective owners.

**Patents**

See [www.patents.datalogic.com](http://www.patents.datalogic.com) for patent list.

**Software Version**

This manual refers to the following software version and later: 610165414

# TABLE OF CONTENTS

---

<b>PREFACE</b> .....	<b>XI</b>
<b>About this Manual</b> .....	<b>xi</b>
<b>Overview</b> .....	<b>xi</b>
Manual Conventions .....	xii
<b>Technical Support</b> .....	<b>xii</b>
Support Through the Website .....	xii
Reseller Technical Support .....	xii
<b>CHAPTER 1. INTRODUCTION</b> .....	<b>1</b>
<b>About the Reader</b> .....	<b>1</b>
<b>Using the QuickScan™ QD2590 Reader</b> .....	<b>1</b>
<b>Programming the Reader</b> .....	<b>2</b>
Configuration Methods .....	2
Programming Bar Codes .....	2
Datalogic Aladdin™ .....	2
<b>CHAPTER 2. SETUP</b> .....	<b>3</b>
<b>Unpacking</b> .....	<b>3</b>
<b>Setting Up the QuickScan™ QD2590 reader</b> .....	<b>3</b>
<b>Connect Host Interface</b> .....	<b>4</b>
RS-232 Serial Connection .....	4
Keyboard Wedge Connection .....	4
USB Connection .....	5
<b>Stand Installation</b> .....	<b>6</b>
Hands-Free Stand/Holder .....	6
<b>Setting Up the QuickScan™ QD2590 Reader</b> .....	<b>7</b>
<b>Reader and LEDs Description</b> .....	<b>8</b>
<b>Using the QuickScan™ QD2590</b> .....	<b>9</b>
<b>Interface Selection</b> .....	<b>11</b>
<b>Configuring the Interface</b> .....	<b>11</b>
<b>Customizing Configuration Settings</b> .....	<b>15</b>
Using the Programming Bar Codes .....	15
Datalogic Aladdin™ Utility .....	15
Interface Settings .....	15
Configuring Other Features .....	16
Software Version Transmission .....	16
Resetting the Product Configuration to Defaults .....	16
Restore Custom Default Configuration .....	16
Restore Factory Configuration .....	17
<b>CHAPTER 3. CONFIGURATION WITH BAR CODES</b> .....	<b>18</b>
<b>Configuration Parameters</b> .....	<b>18</b>
Interface Configuration: .....	18
Parameters common to all interface applications: .....	18
Symbology-specific parameters: .....	19
<b>GLOBAL INTERFACE FEATURES</b> .....	<b>20</b>
Host Commands — Obey/Ignore .....	20
USB Suspend Mode .....	20

<b>RS-232 INTERFACE .....</b>	<b>21</b>
RS-232 STANDARD SETTINGS .....	22
Baud Rate .....	22
Data Bits .....	23
Stop Bits .....	23
Parity .....	24
Handshaking Control .....	25
<b>RS-232/USB-COM INTERFACES .....</b>	<b>26</b>
RS-232/USB-COM SETTINGS .....	27
Intercharacter Delay .....	27
Beep On ASCII BEL .....	28
Beep On Not on File .....	28
ACK NAK Options .....	29
ACK Character .....	30
NAK Character .....	30
ACK NAK Timeout Value .....	31
ACK NAK Retry Count .....	31
ACK NAK Error Handling .....	32
Indicate Transmission Failure .....	32
Disable Character .....	33
Enable Character .....	33
<b>KEYBOARD INTERFACE .....</b>	<b>34</b>
COUNTRY MODE .....	35
<b>Setup on PC to use ALT Universal .....</b>	<b>35</b>
Setting Country Mode .....	36
OTHER KEYBOARD PARAMETERS .....	50
Encoding Type .....	50
ALT Output Type .....	57
Caps Lock State .....	58
Numlock .....	58
Keyboard Numeric Keypad .....	59
Keyboard Send Control Characters .....	59
Wedge Quiet Interval .....	60
Intercharacter Delay .....	60
Intercode Delay .....	61
USB Keyboard Speed .....	62
<b>USB-OEM INTERFACE .....</b>	<b>63</b>
USB-OEM Device Usage .....	64
<b>IBM 46XX INTERFACE .....</b>	<b>65</b>
IBM 46xx Interface Options .....	66
<b>DATA FORMAT .....</b>	<b>67</b>
GLOBAL SETTINGS .....	68
Global Prefix/Suffix .....	68
Case Conversion .....	69
Character Conversion .....	69
Global AIM ID .....	70
GS1-128 AIM ID .....	70
LABEL ID .....	71
Label ID: Pre-loaded Sets .....	71
Label ID: Set Individually Per Symbology .....	72
Label ID Control .....	72
Label ID Symbology Selection .....	73
<b>READING PARAMETERS .....</b>	<b>78</b>
SCANNING FEATURES .....	79
Scan Mode .....	79
Scanning Active Time .....	80
Flash On Time .....	80
Flash Off Time .....	81
Double Read Timeout .....	81
Stand /Base Detection Behavior .....	83
Stand Mode/Object Detection Indication (Stand Mode Flash) .....	84

Stand Mode/Object Detection Sensitivity .....	84
Stand Mode/Object Detection Illumination Off Time .....	85
Corded Stand Mode .....	85
Dock Detection Beep .....	86
LED AND BEEPER INDICATORS .....	87
Power On Alert .....	87
Good Read Beep Type .....	87
Good Read Beep Frequency .....	88
Good Read Beep Length .....	89
Good Read Beeper Volume / Vibration .....	90
Silent Mode .....	91
RGB Good Read Enable .....	91
RGB Good Read Color .....	92
Good Read LED Duration .....	93
Good Read: When to Indicate .....	94
Green Spot Duration .....	95
Illuminator Intensity .....	96
CAMERA CONTROL .....	97
Aiming Pointer .....	97
Aiming Duration Timer .....	97
Pick Mode .....	98
Mobile Phone Mode .....	98
Mobile Phone Saturation Rate .....	99
Decode Negative Image .....	100
Image Capture .....	100
MULTIPLE LABEL READING .....	101
Multiple Labels per Frame .....	101
Multiple Labels Ordering by Code Symbology .....	101
Multiple Labels Ordering by Code Length .....	102
<b>1D SYMBOLOGIES .....</b>	<b>103</b>
DISABLE ALL SYMBOLOGIES .....	104
COUPON CONTROL .....	104
Coupon Control .....	104
UPC-A .....	105
UPC-A Enable/Disable .....	105
UPC-A Check Character Transmission .....	105
Expand UPC-A to EAN-13 .....	106
UPC-A Number System Character Transmission .....	106
UPC-E .....	107
UPC-E Enable/Disable .....	107
UPC-E Check Character Transmission .....	107
Expand UPC-E to EAN-13 .....	108
Expand UPC-E to UPC-A .....	108
UPC-E Number System Character Transmission .....	108
GTIN Formatting .....	109
EAN-13 .....	110
EAN-13 Enable/Disable .....	110
EAN-13 Check Character Transmission .....	110
EAN-13 Flag 1 Character .....	111
EAN-13 to ISBN Conversion .....	111
EAN-13 to ISSN Conversion .....	112
EAN-8 .....	113
EAN-8 Enable/Disable .....	113
EAN-8 Check Character Transmission .....	113
Expand EAN-8 to EAN-13 .....	114
UPC/EAN GLOBAL SETTINGS .....	115
UPC/EAN Price Weight Check .....	115
UPC/EAN Quiet Zones .....	116
Add-Ons .....	116
Optional Add-ons .....	117
Optional Add-On Timer .....	118

GS1 DATABAR™ OMNIDIRECTIONAL .....	119
GS1 DataBar Omnidirectional Enable/Disable .....	119
GS1 DataBar Omnidirectional to GS1-128 Emulation .....	119
GS1 DATABAR™ EXPANDED .....	120
GS1 DataBar Expanded Enable/Disable .....	120
GS1 DataBar Expanded to GS1-128 Emulation .....	120
GS1 DataBar Expanded Length Control .....	121
GS1 DataBar Expanded Set Length 1 .....	121
GS1 DataBar Expanded Set Length 2 .....	122
GS1 DATABAR™ LIMITED .....	123
GS1 DataBar Limited Enable/Disable .....	123
GS1 DataBar Limited to GS1-128 Emulation .....	123
CODE 39 .....	124
Code 39 Enable/Disable .....	124
Code 39 Check Character Calculation .....	124
Code 39 Check Character Transmission .....	125
Code 39 Start/Stop Character Transmission .....	125
Code 39 Full ASCII .....	126
Code 39 Quiet Zones .....	126
Code 39 Length Control .....	127
Code 39 Set Length 1 .....	127
Code 39 Set Length 2 .....	128
TRIOPTIC CODE .....	129
Trioptic Code Enable/Disable .....	129
CODE 39 DANISH PPT .....	129
Code 39 Danish PPT Enable/Disable .....	129
CODE 39 PZN .....	130
Code 39 PZN Enable/Disable .....	130
CODE 39 LA POSTE .....	130
Code 39 La Poste Enable/Disable .....	130
CODE 32 (ITALIAN PHARMACEUTICAL) .....	131
Code 32 Enable/Disable .....	131
Code 32 Feature Setting Exceptions .....	131
Code 32 Check Character Transmission .....	131
Code 32 Start/Stop Character Transmission .....	132
CODE 39 CIP HR (FRENCH PHARMACEUTICAL) .....	132
Code 39 CIP HR Enable/Disable .....	132
CODE 128 .....	133
Code 128 Enable/Disable .....	133
Expand Code 128 to Code 39 .....	133
Code 128 Check Character Transmission .....	134
Code 128 Function Character Transmission .....	134
Code 128 Quiet Zones .....	135
Code 128 Length Control .....	135
Code 128 Set Length 1 .....	136
Code 128 Set Length 2 .....	136
GS1-128 .....	137
GS1-128 Enable .....	137
INTERLEAVED 2 OF 5 (1 2 OF 5) .....	138
1 2 of 5 Enable/Disable .....	138
1 2 of 5 Check Character Calculation .....	139
1 2 of 5 Check Character Transmission .....	140
1 2 of 5 Length Control .....	141
1 2 of 5 Set Length 1 .....	141
1 2 of 5 Set Length 2 .....	142
INTERLEAVED 2 OF 5, FEBRABAN (DESK MODELS ONLY) .....	143
Interleaved 2 of 5, Febraban format Enable / Disable .....	143
INTERLEAVED 2 OF 5 CIP HR .....	144
Interleaved 2 of 5 CIP HR Enable/Disable .....	144
MATRIX 2 OF 5 .....	145

Matrix 2 of 5 Enable/Disable .....	145
Matrix 2 of 5 Check Character Calculation .....	145
Matrix 2 of 5 Check Character Transmission .....	146
Matrix 2 of 5 Length Control .....	146
Matrix 2 of 5 Set Length 1 .....	147
Matrix 2 of 5 Set Length 2 .....	147
STANDARD 2 OF 5 .....	148
Standard 2 of 5 Enable/Disable .....	148
Standard 2 of 5 Check Character Calculation .....	148
Standard 2 of 5 Check Character Transmission .....	149
Standard 2 of 5 Length Control .....	149
Standard 2 of 5 Set Length 1 .....	150
Standard 2 of 5 Set Length 2 .....	150
COMPRESSED 2 OF 5 .....	151
Compressed 2 of 5 Enable/Disable .....	151
Compressed 2 of 5 Check Character Calculation .....	151
Compressed 2 of 5 Check Character Transmission .....	152
Compressed 2 of 5 Length Control .....	152
Compressed 2 of 5 Set Length 1 .....	153
Compressed 2 of 5 Set Length 2 .....	153
DATALOGIC 2 OF 5 .....	154
Datalogic 2 of 5 Enable/Disable .....	154
Datalogic 2 of 5 Check Character Calculation .....	154
Datalogic 2 of 5 Check Character Transmission .....	155
Datalogic 2 of 5 Length Control .....	155
Datalogic 2 of 5 Set Length 1 .....	156
Datalogic 2 of 5 Set Length 2 .....	156
INDUSTRIAL 2 OF 5 .....	157
Industrial 2 of 5 Enable/Disable .....	157
Industrial 2 of 5 Check Character Calculation .....	157
Industrial 2 of 5 Check Character Transmission .....	158
Industrial 2 of 5 Length Control .....	158
Industrial 2 of 5 Set Length 1 .....	159
Industrial 2 of 5 Set Length 2 .....	159
IATA .....	160
IATA Enable/Disable .....	160
IATA Check Character Transmission .....	160
FOLLETT 2 OF 5 .....	161
Follett 2 of 5 Enable/Disable .....	161
CODABAR .....	162
Codabar Enable/Disable .....	162
Codabar Check Character Calculation .....	162
Codabar Check Character Transmission .....	163
Codabar Start/Stop Character Transmission .....	163
Codabar Start/Stop Character Set .....	164
Codabar Start/Stop Character Match .....	164
Codabar Quiet Zones .....	165
Codabar Length Control .....	166
Codabar Set Length 1 .....	166
Codabar Set Length 2 .....	167
ABC CODABAR .....	168
ABC Codabar Enable/Disable .....	168
ABC Codabar Concatenation Mode .....	168
ABC Codabar Dynamic Concatenation Timeout .....	169
ABC Codabar Force Concatenation .....	169
ISBT 128 .....	170
ISBT 128 Concatenation .....	170
ISBT 128 Concatenation Mode .....	170
ISBT 128 Dynamic Concatenation Timeout .....	171
ISBT 128 Force Concatenation .....	172
ISBT 128 Advanced Concatenation Options .....	172

CODE 11 .....	173
Code 11 Enable/Disable .....	173
Code 11 Check Character Calculation .....	173
Code 11 Check Character Transmission .....	174
Code 11 Length Control .....	174
Code 11 Set Length 1 .....	175
Code 11 Set Length 2 .....	175
CODE 93 .....	176
Code 93 Enable/Disable .....	176
Code 93 Check Character Calculation .....	176
Code 93 Check Character Transmission .....	177
Code 93 Length Control .....	177
Code 93 Set Length 1 .....	178
Code 93 Set Length 2 .....	178
Code 93 Quiet Zones .....	179
MSI .....	180
MSI Enable/Disable .....	180
MSI Check Character Calculation .....	180
MSI Check Character Transmission .....	181
MSI Length Control .....	181
MSI Set Length 1 .....	182
MSI Set Length 2 .....	182
PLESSEY .....	183
Plessey Enable/Disable .....	183
Plessey Check Character Calculation .....	183
Plessey Check Character Transmission .....	184
Plessey Length Control .....	184
Plessey Set Length 1 .....	185
Plessey Set Length 2 .....	185
BC412 .....	186
BC412 Enable/Disable .....	186
BC412 Check Character Calculation .....	186
BC412 Length Control .....	187
BC412 Set Length 1 .....	188
BC412 Set Length 2 .....	188
<b>2D SYMBOLOGIES .....</b>	<b>189</b>
2D GLOBAL FEATURES .....	190
2D Maximum Decoding Time .....	191
2D Structured Append .....	192
2D Normal/Inverse Symbol Control .....	192
AZTEC CODE .....	193
Aztec Code Enable / Disable .....	193
Aztec Code Length Control .....	193
Aztec Code Set Length 1 .....	194
Aztec Code Set Length 2 .....	194
CHINA SENSIBLE CODE .....	195
China Sensible Code Enable / Disable .....	195
China Sensible Code Length Control .....	195
China Sensible Code Set Length 1 .....	196
China Sensible Code Set Length 2 .....	196
DATA MATRIX .....	197
Data Matrix Enable / Disable .....	197
Data Matrix Square/Rectangular Style .....	197
Data Matrix Length Control .....	198
Data Matrix Set Length 1 .....	198
Data Matrix Set Length 2 .....	199
GS1 DOTCODE .....	200
DotCode Enable .....	200
DotCode High Resolution Enable .....	200
DotCode Position-based Decoding .....	201
Additional Options .....	201



MAXICODE .....	202
Maxicode Enable / Disable .....	202
Maxicode Primary Message Transmission .....	202
Maxicode Length Control .....	203
Maxicode Set Length 1 .....	203
Maxicode Set Length 2 .....	204
PDF417 .....	205
PDF417 Enable / Disable .....	205
PDF417 Length Control .....	205
PDF417 Set Length 1 .....	206
PDF417 Set Length 2 .....	206
MICRO PDF417 .....	207
Micro PDF417 Enable / Disable .....	207
Micro PDF417 Code 128 GS1-128 Emulation .....	207
Micro PDF417 Length Control .....	208
Micro PDF417 Set Length 1 .....	208
Micro PDF417 Set Length 2 .....	209
QR CODE .....	210
QR Code Enable / Disable .....	210
QR Code Length Control .....	210
QR Code Set Length 1 .....	211
QR Code Set Length 2 .....	211
MICRO QR CODE .....	212
Micro QR Code Enable / Disable .....	212
Micro QR Code Length Control .....	212
Micro QR Code Set Length 1 .....	213
Micro QR Code Set Length 2 .....	213
UCC COMPOSITE .....	214
UCC Optional Composite Timer .....	214
Postal Code Selection .....	215
Postnet BB Control .....	216
<b>OCR DECODING .....</b>	<b>217</b>
OCR Decoding Predefined Templates .....	218
<b>MOTION FEATURES .....</b>	<b>219</b>
Motionless Timeout .....	220
Motion Sensitivity .....	220
High Motion Immunity .....	221
Motion Aiming Control .....	221
DOF Enhancement .....	222

## **CHAPTER 4. REFERENCES..... 223**

### **RS-232 Parameters ..... 224**

#### **RS-232 Only ..... 224**

Baud Rate ..... 224

Data Bits ..... 224

Stop Bits ..... 224

Parity ..... 224

Handshaking Control ..... 224

#### **RS-232/USB COM Parameters ..... 225**

Intercharacter Delay ..... 225

ACK NAK Options ..... 226

ACK Character ..... 226

NAK Character ..... 227

ACK NAK Timeout Value ..... 228

ACK NAK Retry Count ..... 229

Disable Character ..... 230

Enable Character ..... 231

#### **Keyboard Interface ..... 232**

Wedge Quiet Interval ..... 232

Intercharacter Delay ..... 232

Intercode Delay ..... 234

<b>Data Format .....</b>	<b>235</b>
Data Editing .....	235
Please Keep In Mind... .....	235
Global Prefix/Suffix .....	236
Example: Setting a Prefix .....	236
Global AIM ID .....	237
Label ID .....	238
Label ID: Pre-loaded Sets .....	238
Label ID: Set Individually Per Symbology .....	240
Character Conversion .....	242
<b>Scanning Features .....</b>	<b>243</b>
Scan Mode .....	243
Scanning Active Time .....	244
Aiming Duration Time .....	245
Flash On Time .....	246
Flash Off Time .....	247
<b>LED and Beeper Indicators .....</b>	<b>248</b>
Good Read LED Duration .....	248
<b>Symbologies .....</b>	<b>249</b>
Set Length .....	249
Set Length 1 .....	249
Set Length 2 .....	250
<b>APPENDIX A. TECHNICAL SPECIFICATIONS .....</b>	<b>251</b>
<b>QD2590 Technical Specifications .....</b>	<b>251</b>
<b>Common Reading Characteristics .....</b>	<b>253</b>
<b>Decoding Capabilities .....</b>	<b>254</b>
<b>LED and Beeper Indications .....</b>	<b>255</b>
<b>User Indications for QD2590 .....</b>	<b>255</b>
<b>Programming Mode .....</b>	<b>256</b>
<b>Troubleshooting .....</b>	<b>256</b>
<b>APPENDIX B. STANDARD DEFAULTS .....</b>	<b>258</b>
Default exceptions .....	270
<b>APPENDIX C. SAMPLE BARCODES.....</b>	<b>272</b>
<b>Sample Barcodes .....</b>	<b>272</b>
1D Barcodes .....	272
GS1 Databar™ (RSS) .....	274
GS1 Databar™ (-14) .....	274
2D Barcodes .....	275
<b>APPENDIX D. KEYPAD .....</b>	<b>277</b>
<b>APPENDIX E. SCANCODE TABLES .....</b>	<b>279</b>
<b>Control Character Emulation .....</b>	<b>279</b>
Single Press and Release Keys .....	279
<b>Interface Type PC AT PS/2, USB-Keyboard or USB-Keyboard for APPLE .....</b>	<b>280</b>
<b>Interface Type PC AT PS/2, USB-Keyboard or USB-Keyboard for APPLE (continued) .....</b>	<b>281</b>
<b>Interface Type PC AT PS/2 Alt Mode or USB-Keyboard Alt Mode .....</b>	<b>282</b>
<b>Interface Type PC AT PS/2 Alt Mode or USB-Keyboard Alt Mode (continued) .....</b>	<b>283</b>
<b>Digital Interface .....</b>	<b>284</b>
<b>IBM31xx 102-key .....</b>	<b>285</b>
<b>IBM XT .....</b>	<b>287</b>
<b>Microsoft Windows Codepage 1252 .....</b>	<b>289</b>
<b>APPENDIX F. ASCII CHART.....</b>	<b>290</b>

# PREFACE

---

## ABOUT THIS MANUAL

This Product Reference Guide (PRG) is provided for users seeking advanced technical information, including connection, programming, maintenance and specifications. The Quick Reference Guide (QRG) and other publications associated with this product are downloadable free of charge from the website listed on the back cover of this manual.

Typically, units are factory-programmed for the most common terminal and communications settings. If you need to modify any programmable settings, custom configuration can be accomplished by scanning the programming bar codes within this guide.

Programming can alternatively be performed using the Datalogic Aladdin™ Configuration application, which is available from the Datalogic website listed on the back cover of this manual. This multi-platform utility program allows device configuration using a PC. It communicates to the device using a serial or USB cable and can also create configuration bar codes to print.

## OVERVIEW

**Chapter 1**, Introduction provides a product overview, and general information about programming the reader.

**Chapter 2**, Setup presents information about unpacking and setting up the reader, and interface configuration bar codes and details.

**Chapter 3**, Configuration Using Bar Codes provides instructions and bar code labels for customizing your reader. There are different sections for interface types, general features, data formatting, and symbology-specific features.

**Chapter 4**, References provides details concerning programmable features.

**Appendix A**, Technical Specifications lists physical and performance characteristics, as well as environmental specifications. It also provides standard cable pin-outs and descriptions of the functions and behaviors of the reader's LED and Beeper indicators.

**Appendix B**, references common factory default settings for reader features and options.

**Appendix C**, Sample Bar Codes offers sample bar codes of several common symbologies.

**Appendix D**, Keypad includes numeric bar codes to be scanned for certain parameter settings.

**Appendix E**, Scancode Tables lists control character emulation information for Wedge and USB Keyboard interfaces.

**Appendix F**, ASCII Chart lists hexadecimal reference values for ASCII characters.

## Manual Conventions

The following conventions are used in this document:

The symbols listed below are used in this manual to notify the reader of key issues or procedures that must be observed when using the reader:



**NOTE:** This symbol draws attention to details or procedures that may be useful in improving, maintaining, or enhancing the performance of the hardware or software being discussed.



**CAUTION:** This symbol advises you of actions that could damage equipment or property.



**WARNING:** This symbol advises you of actions that could result in harm or injury to the person performing the task.



**HIGH VOLTAGE:** This symbol alerts the user they are about to perform an action involving, either a dangerous level of voltage, or to warn against an action that could result in damage to devices or electrical shock.



**LASER:** This symbol alerts the user they are about to perform an action involving possible exposure to laser light radiation.



**GROUNDING:** This symbol advises you to pay particular attention to the grounding instructions for correct device functioning.



**ESD:** This symbol identifies a procedure that requires you take measures to prevent Electrostatic Discharge (ESD) e.g., use an ESD wrist strap. Circuit boards are most at risk. Please follow ESD procedures.

## TECHNICAL SUPPORT

### Support Through the Website

Datalogic provides several services as well as technical support through its website. Log on to ([www.datalogic.com](http://www.datalogic.com)).

For quick access, from the home page click on the search icon , and type in the name of the product you're looking for. This allows you access to download Data Sheets, Manuals, Software & Utilities, and Drawings.

Hover over the Support & Service menu for access to Services and Technical Support.

### Reseller Technical Support

An excellent source for technical assistance and information is an authorized Datalogic reseller. A reseller is acquainted with specific types of businesses, application software, and computer systems and can provide individualized assistance.

# CHAPTER 1

## INTRODUCTION

---

### ABOUT THE READER

The QuickScan™ QD2590 product series represents the hand-held entry level corded scanner by Datalogic. It has been specifically created for small to medium size Retailers, such as groceries and convenience stores, operating in both food and non-food sectors. Providing the quickest response to the operator for its class of products, the QD2590 scanner is able to capture whatever barcode, hard-to-read, poor or damaged. It easily scans from mobile devices and through plexiglass barriers. Lightweight and easy to handle also for female users, it is a reliable and seamless companion throughout the whole shift.

The QD2590 scanner features a precise aiming system developed with the unique intent to reduce visual stress of the operator during the daily scanning activities. The outstanding aimer consists of two blue LED triangles pointing at the targeted bar code. The Green Spot confirms the good read, being perfectly centered on the barcode and between the two triangles.

Very responsive at the pull of the trigger, the QuickScan QD2590 provides a superior robustness for its class of products, thanks to an accurate design and quality of parts, right there where the product is mostly stressed.

Perfect for manual reading, the QuickScan QD2590 uses Datalogic's Motionix™ motion detection technology that detects the operator's natural actions to automatically switch the scanner into "ready to read" scan mode. The product range is wide, with two colors – black and white – and a variety of different stands, holders and accessories to provide the best fit for each working environment.

### USING THE QUICKSCAN™ QD2590 READER

To read a symbol or capture an image, simply aim the reader and pull the trigger. The QuickScan™ QD2590 is a powerful omni-directional reader, so the orientation of the symbol is not important. Datalogic's unique 'Green Spot' for good-read feedback helps to improve productivity in noisy environments or in situations where silence is required. When positioning the product into the stand, the magnetic coupling will make the reader automatically detect a bar code inside the field of view, and switch the reading system from trigger mode to autosense mode.

The QuickScan™ QD2590 reliably decodes all standard 1D (linear) and 2D bar codes, including GS1 DataBar™ linear codes, Postal Codes (China Post), Stacked Codes (such as GS1 DataBar Expanded Stacked, GS1 DataBar Stacked, GS1 DataBar, Stacked Omnidirectional). The data stream - acquired from decoding a symbol - is rapidly sent to the host. The reader is immediately available to read another symbol.

Figure 1 - Correct positioning of the reader

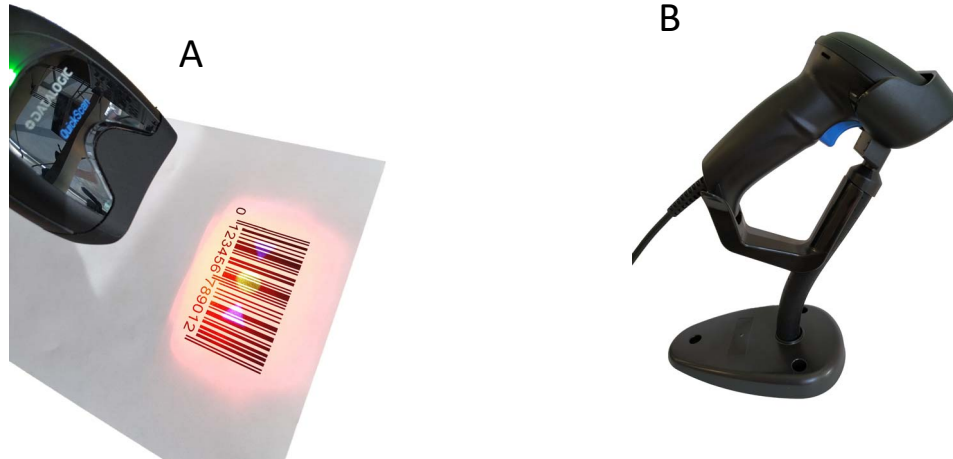

## PROGRAMMING THE READER

### Configuration Methods

#### Programming Bar Codes

The reader is factory-configured with a standard set of default features. After scanning the interface bar code, you can select other options and customize your reader through use of the instructions and programming bar code labels available in the corresponding features section for your interface. Customizable settings for many features are found in [Configuration Parameters, starting on page 18](#).

Some programming labels, like “Restore Custom Defaults”, require only the scan of the single label to enact the change. Most, however, require the reader to be placed in Programming Mode prior to scanning them. Scan an ENTER/EXIT bar code once to enter Programming Mode. Once the reader is in Programming Mode, scan a number of parameter settings before scanning the ENTER/EXIT bar code a second time, which will then accept your changes, exit Programming Mode and return the reader to normal operation.



**NOTE: There are some exceptions to the typical programming sequence described above. Please read the description and setting instructions carefully when configuring each programmable feature.**

#### Datalogic Aladdin™

Datalogic Aladdin™ is a multi-platform utility program providing a quick and user-friendly configuration method via the RS-232/USB-COM interface. Aladdin allows you to program the reader by selecting configuration commands through a user-friendly graphical interface running on a PC. These commands are sent to the reader over the selected communication interface, or they can be printed as bar codes to be scanned. Aladdin also facilitates image capturing.

In addition, Aladdin makes it easy to upgrade the handheld’s firmware, to attain the benefits of new reader features. Reference the Datalogic Aladdin™ Online Help for more details.

Aladdin is available for download free of charge on the Datalogic website.

# CHAPTER 2

## SETUP

---

### UNPACKING

Check carefully to ensure the reader and any cables or accessories ordered are present and undamaged. If any damage occurred during shipment, contact "[Technical Support](#)" on page xii.

### SETTING UP THE QUICKSCAN™ QD2590 READER

Follow the steps provided in this section to connect and get your reader up and communicating with its host:

1. Connect the Interface Cable to the reader as shown in Figure 2. To disconnect the cable, insert a paper clip or similar object into the opening shown.
2. Connect the other end to the Host (see the next section, "[Connect Host Interface](#)" on page 4 and Figure 3).
3. Modify "[Customizing Configuration Settings](#)" on page 15 (only if modifications are needed from factory settings).

## CONNECT HOST INTERFACE

The reader kit you ordered to match your interface should provide a compatible cable for your installation. If this is not so, contact "[Technical Support](#)" on page xii.

The reader can communicate using the interfaces illustrated below.

For corded versions, connect the reader cable by inserting the cable into the handle as shown in the following Figure.

To remove the interface cable from the reader, first locate the hole on the back of the handle. Next, take a paper clip and modify it as shown in the figure below. Insert the end of the paper clip into the hole and press it to push on the clip that holds the connector. As you apply pressure, pull out the cable.

When reinserting the cable, make sure the connector clip is on the same side as the reader release hole. Insert the cable, it should click when it is fully inserted.



**NOTE:** We recommend the use of a perfectly straight new paper clip to make the operation easier (see the figure below).

**Figure 2. Cable Connection/Disconnection at the Reader**

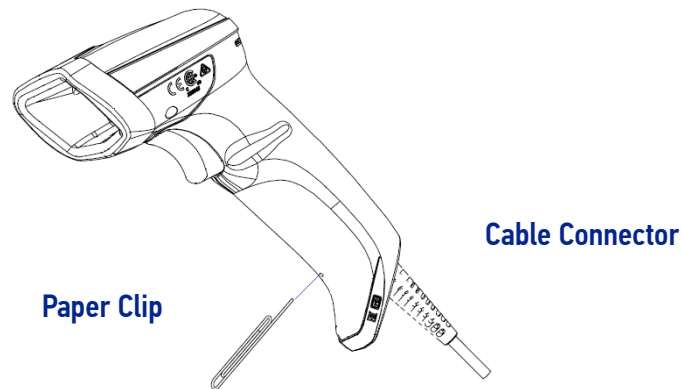

## RS-232 Serial Connection

Turn off power to the terminal/PC and connect the reader to the terminal/PC serial port via the RS-232 cable as shown in Figure 3. If the terminal will not support POT (Power Off the Terminal) to supply reader power, use the approved power supply (AC Adapter). Plug the AC Adapter barrel connector into the socket on the RS-232 cable connector and the AC Adapter plug into a standard power outlet.

**RS-232:** The reader can communicate with a standard or Wincor-Nixdorf (W-N) RS-232 host.

**RS-232 OPOS:** This interface is used for OPOS/UPOS/JavaPOS systems.

## Keyboard Wedge Connection

The Keyboard Wedge cable has a 'Y' connection from the reader. Connect the female to the male end from the keyboard and the remaining end at the keyboard port at the terminal/PC.

**Keyboard Wedge (KBW):** When connected using this interface, the host interprets scanned data as keystrokes and supports several international keyboards (for the Windows® environment). See "[Setting Country Mode](#)" on page 36 for a full listing.



## USB Connection

Connect the reader to a USB port on the terminal/PC using the correct USB cable for the interface type you ordered.

**USB:** Select to communicate either by USB OEM, USB COM STD, or USB Keyboard interface types by scanning the appropriate interface type bar codes available in this manual. The default interface is USB-KBD, or RS-232-STD.

**Figure 3 - Connection to the Host**

USB



Wedge

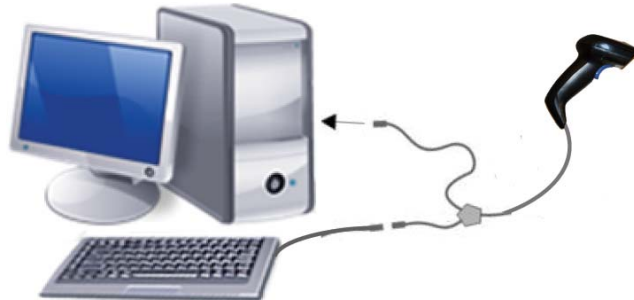

RS-232



**NOTE:** Specific cables are required for connection to different hosts. The connections illustrated in Figure 3 are examples only. Actual connectors may vary from those illustrated, but the steps to connect the reader remain the same.

## STAND INSTALLATION

### Hands-Free Stand/Holder

An accessory is available which holds the reader (except those with integrated stand) at a convenient angle, allowing hands free scanning of items.

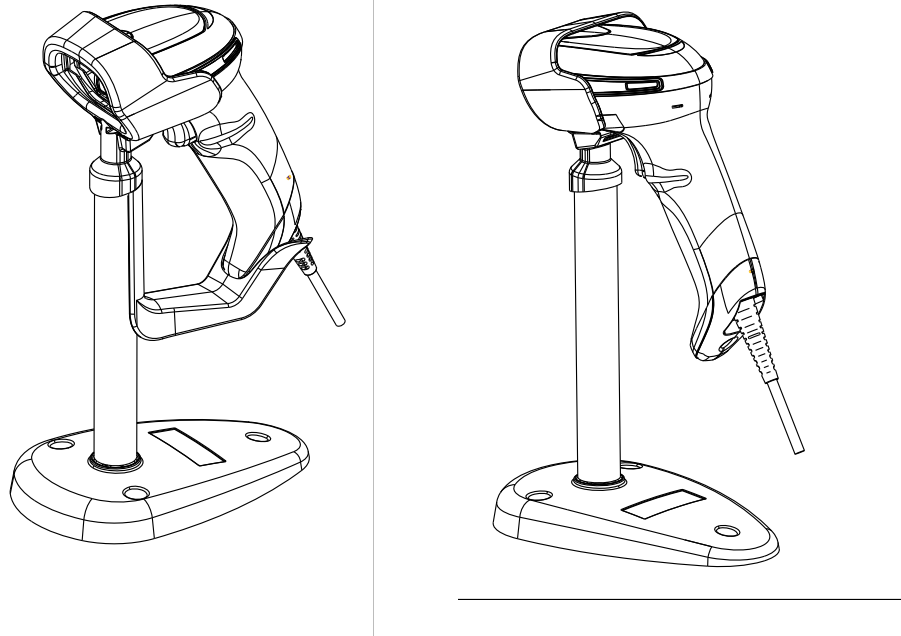

It can also be used as a holder. The holder “cup” can be positioned in any of the angles shown in the figure below. The Desk model automatically recognizes the insertion and changes its Scan Mode to allow the user to operate in hands-free mode.

**Figure 4 - Adjusting the Stand Arm**

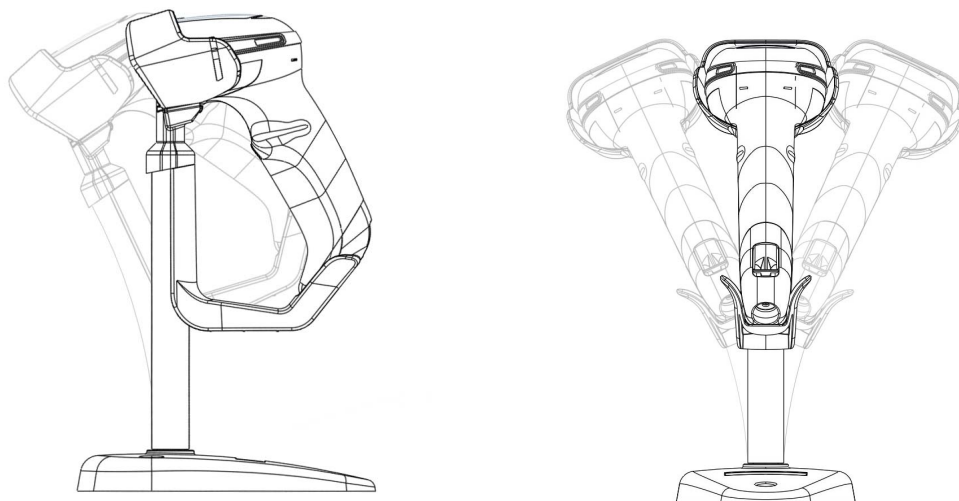

## SETTING UP THE QUICKSCAN™ QD2590 READER

Follow the steps below to connect and get your reader up and communicating with its host.

1. Select the Interface Type on [page 11](#).

## READER AND LEDS DESCRIPTION

LED on the gun provides information about the data transmission.

Figure 5 - QuickScan™ QD2590 LEDs

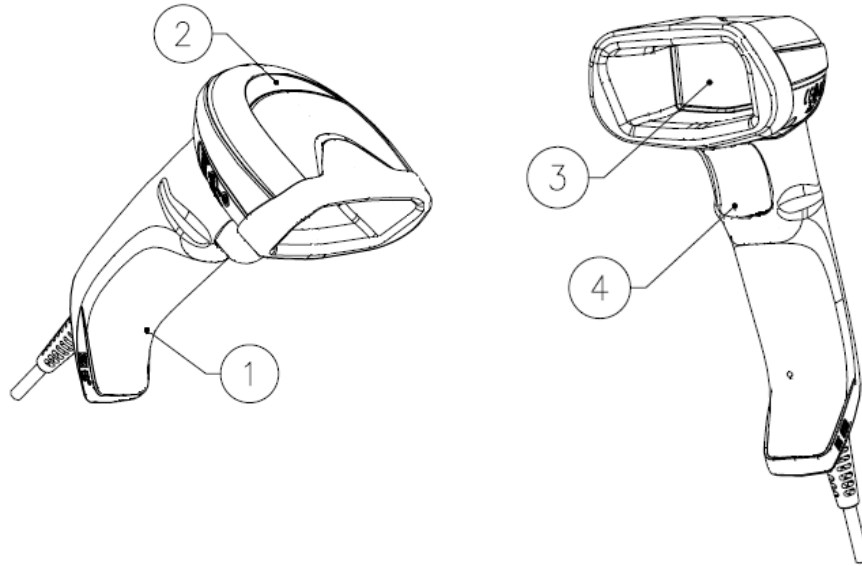

- 1. Cable Release Hole
- 2. LED

- 3. Scan Window
- 4. Trigger

## USING THE QUICKSCAN™ QD2590

The QuickScan™ QD2590 normally functions by capturing and decoding codes. The aiming system is activated on trigger pull and indicates the center of the field of view which should be positioned over the bar code:

### Aiming System

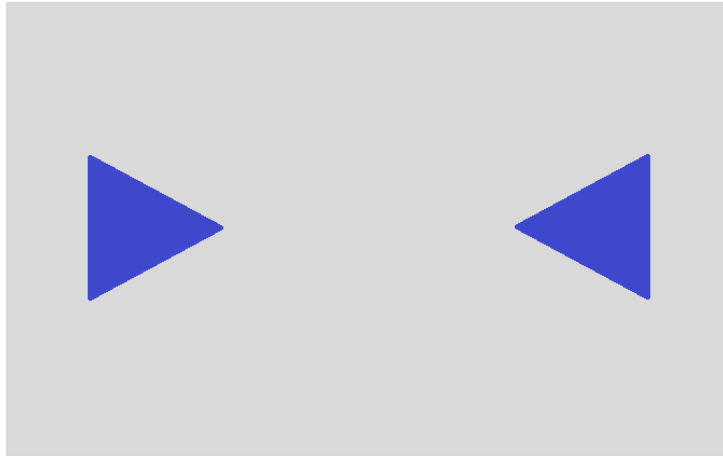

### Relative Size and Location of Aiming System Pattern on 2D Matrix Symbol

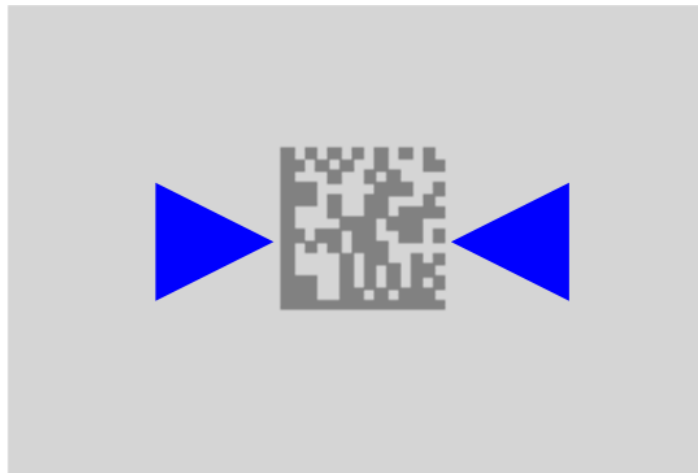

### Relative Size and Location of Aiming System Pattern on Linear bar code

A red beam illuminates the label. The field of view indicated by the aiming system will be smaller when the reader is closer to the bar code and larger when it is farther from the code. Symbologies with smaller bars or elements (mil size) should be read closer to the unit. Symbologies with larger bars or elements (mil size) should be read farther from the unit. If the aiming system is centered and the entire bar code is within the aiming field, you will get a good read. Successful reading is signaled by an audible tone plus a good-read green spot LED indicator.

### Relative Size and Location of Green Spot

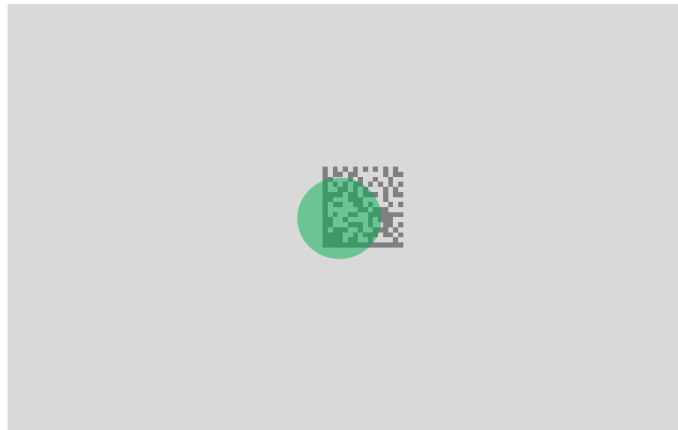

## INTERFACE SELECTION

Upon completing the physical connection between the reader and its host, proceed directly to "Configuring the Interface" on page 11 for information and programming for the interface type the reader is connected to (for example: RS-232, Keyboard Wedge, USB, etc.) and scan the appropriate bar code in that section to select your system's correct interface type.

The reader, depending upon the model, will support one of the following sets of host interfaces:

- USB (Keyboard, COM, OEM)
- USB Composite (Keyboard + COM)
- USB HID POS
- USB Toshiba TEC
- RS-232 STD
- RS-232 WN
- RS232 OPOS
- Keyboard Wedge IBM46XX port 9b (a specific cable is required)
- Datalogic Magellan Scanners' specific interface



## CONFIGURING THE INTERFACE



Scan the programming bar code from the following section which selects the appropriate interface type to match the system the reader will be connected to. Next, proceed to the corresponding chapter in this manual (also listed in the table) to configure any desired settings and features associated with that interface.



**NOTE: Unlike some other programming features and options, interface selections require that you scan only one programming bar code label. DO NOT scan an ENTER/EXIT bar code prior to scanning an interface selection bar code. Some interfaces require the reader to start in the disabled state when powered up. If additional reader configuration is desired while in this state, pull the trigger and hold for 5 seconds. The reader will change to a state that allows programming with bar codes.**





**Table 1 - Available Interfaces**

RS-232	
RS-232 standard interface <i>*Not supported on USB only models</i>	 Select RS232-STD
 Select RS232-WN	RS-232 Wincor-Nixdorf
RS-232 for use with OPOS/UPOS/JavaPOS	 Select RS-232 OPOS

USB-COM <sup>A</sup>	
 Select USB-COM-STD	USB-COM (simulates RS-232 standard interface)
USB-Composite (combines USB-KBD emulation and USB-COM)	 Select USB-Composite

a. USB-COM driver needs to be installed for these interfaces to work. Please download it from [www.datalogic.com](http://www.datalogic.com)









OTHER INTERFACES	
 Select IBM-P9B	IBM 46xx Port 9B interface
USB HID POS	 Select USB HID POS
 Select USB Toshiba TEC	USB Toshiba TEC
Datalogic Magellan Scanners' specific interface, USB AUX	 Select Datalogic Magellan Scanners' USB AUX
 Magellan RS232 AUX port	Datalogic Magellan RS232 AUX port

USB-OEM	
 Select USB-OEM	USB-OEM (can be used for OPOS/UPOS/JavaPOS)



**NOTE:** If you erroneously read the **USB-OEM** interface selection code, it is required to press and hold the trigger to unlock the reader. Then read the correct interface bar code. This will work only at power-up. Please reconnect the reader if the unlock is not successful.

KEYBOARD	
AT, PS/2 25-286, 30-286, 50, 50Z, 60, 70, 80, 90 & 95 w/Standard Key Encoding	 Select KBD-AT
 Select KBD-AT-NK	Keyboard Wedge for IBM AT PS2 with standard key encoding but without external keyboard
AT, PS/2 25-286, 30-286, 50, 50Z, 60, 70, 80, 90 & 95 w/Alternate Key	 Select KBD-AT-ALT
 Select KBD-AT-ALT-NK	Keyboard Wedge for IBM AT PS2 with alternate key encoding but without external keyboard
USB Keyboard with standard key encoding	 Select USB Standard Keyboard
 Select USB Alternative Keyboard	USB Keyboard with alternative key encoding

# CUSTOMIZING CONFIGURATION SETTINGS

## Using the Programming Bar Codes

This manual contains feature descriptions and bar codes which allow you to reconfigure your reader. Some programming bar code labels, like [Resetting the Product Configuration to Defaults, starting on page 16](#), require only the scan of that single label to enact the change.

Most of the programming labels in this manual, however, require the reader to be placed in Programming Mode prior to scanning them. Scan an ENTER/EXIT bar code once to enter Programming Mode. Once the reader is in Programming Mode, you can scan a number of parameter settings before scanning the ENTER/EXIT bar code a second time, which will then accept your changes, exit Programming Mode and return the reader to normal operation.



**NOTE: There are some exceptions to the typical programming sequence described above. Please read the description and setting instructions carefully when configuring each given programmable feature.**

## Datalogic Aladdin™ Utility

Programming can alternatively be performed using the Datalogic Aladdin™ Configuration application which is available for free download from the Datalogic website listed on the back cover of this manual. This multi-platform utility program allows device configuration using a PC. It communicates to the device using a serial or USB cable and can also create configuration bar codes to print.

Datalogic Aladdin™ is a multi-platform utility program providing a quick and user-friendly configuration method via the RS-232/USB-COM interface. The Aladdin utility is available on the Datalogic website. Aladdin allows you to program the reader by selecting configuration commands through a user-friendly graphical interface running on a PC. These commands are sent to the reader over the selected communication interface, or they can be printed as bar codes to be scanned.

Aladdin also provides the ability to perform a software upgrade for the connected device (see the Datalogic Aladdin™ Help On-Line for more details).

## Interface Settings

The reader is typically factory-configured with a set of default features standard to the interface type you ordered. See [Appendix B, Standard Defaults](#).

Global Interface Features, starting on [page 20](#) provides settings configurable by all interface types. If your installation requires you to further customize your reader, you can select other options through use of the instructions and programming bar codes available in the appropriate section for your interface.

- ["RS-232 INTERFACE" on page 21](#)
- ["RS-232/USB-COM Interfaces" on page 26](#)
- [RS232 OPOS on page 12](#)
- [USB Composite \(COM + Keyboard\) on page 12](#)
- [KEYBOARD INTERFACE on page 34](#)
- [USB-OEM INTERFACE on page 63](#)

## Configuring Other Features

If your installation requires different programming than the standard factory default settings, the following sections of this manual allow configuration of non-interface-specific settings you might require:

**Configuration Using Bar Codes:** General Features includes programming for scanning, beeper and LED indicators and other such universal settings.

**Reading Parameters:** Reading Parameters include programming for scanning, beeper and LED indicators and other universal settings.

**1D Symbologies:** Includes options concerning the bar code label types (symbologies). These settings allow you to enable/disable symbologies, set label lengths, require check digit, etc.

## Software Version Transmission

The software version of the device can be transmitted over the RS-232, Keyboard and USB interfaces by scanning the following label.



Transmit Software Version

## Resetting the Product Configuration to Defaults

### Restore Custom Default Configuration

If you aren't sure what programming options are in your reader, or you've changed some options and want to restore the Custom Default Configuration that may have been saved in the reader, scan the Restore Custom Default Configuration bar code below. This will restore the custom configuration for the currently active interface.



**NOTE: Custom defaults are based on the interface type. Configure the reader for the correct interface before scanning this label.**



Restore Custom Default Configuration

## Restore Factory Configuration

If you want to restore the Factory Configuration for your reader, scan either the Restore USA Factory Configuration bar code or the Restore EU Factory Configuration bar code below. Both labels restore the reader configuration to the factory settings, including the interface type. The USA label restores Label IDs to those historically used in the USA. The EU label restores Label IDs to those historically used in Europe. The Label ID sets for USA and EU are shown in the “Label ID” Section on [page 72](#) of this manual.



Restore USA Factory Configuration



Restore EU Factory Configuration

The programming items listed in the following sections show the factory default settings for each of the menu commands.

# CHAPTER 3

## CONFIGURATION WITH BAR CODES

---

This and following sections provide programming bar codes to configure your reader by changing the default settings. For details about additional methods of programming, see "Customizing Configuration Settings" on page 15.



**NOTE: You must first enable your PowerScan to read bar codes in order to use this section. If you have not done this, go to Setup, starting on page 3 and complete the appropriate procedure.**

### CONFIGURATION PARAMETERS

Once the reader is set up, you can change the default parameters to meet your application needs. Refer to [Standard Defaults, starting on page 258](#) for initial configuration in order to set the default values and select the interface for your application.



**NOTE: In the following sections, text shown with a green star indicates a factory default value.**

★ This is an example of a default value.

The following configuration parameters are divided into logical groups, making it easy to find the desired function based on its reference group.

#### Interface Configuration:

- [RS-232 Standard Settings, starting on page 22](#)
- [RS-232/USB-COM Settings, starting on page 27](#)
- [Keyboard Interface, starting on page 34](#)
- [USB-OEM Interface, starting on page 63](#)

#### Parameters common to all interface applications:

- [Global Prefix/Suffix, starting on page 68](#)
- [Data Format, starting on page 67](#) gives options to control the messages sent to the Host system by selecting parameters to control the message strings sent to the handheld.
- [Reading Parameters, starting on page 78](#) controls various operating modes and indicators status functioning.

## Symbology-specific parameters:

1D Symbologies, starting on page 103 and 2D Symbologies, starting on page 189 define options for all symbologies and provides the programming bar codes necessary for configuring these features.



**NOTE: You must first enable your reader to read bar codes in order to use this section. If you have not done this, go to Setup, starting on page 3 and complete the appropriate procedure.**

### To program features:

1. Scan the ENTER/EXIT PROGRAMMING bar code, available at the top of each programming page, when applicable.
2. Scan the bar code to set the desired programming feature. You may need to cover unused bar codes on the page, and possibly the facing page, to ensure that the reader reads only the bar code you intend to scan.
3. If additional input parameters are needed, go to [Appendix D](#), and scan the appropriate characters from the keypad.



**NOTE: Additional information about many features can be found in the References, starting on page 223.**

**If you make a mistake before the last character, scan the CANCEL bar code to abort and not save the entry string. You can then start again at the beginning.**

4. Complete the programming sequence by scanning the ENTER/EXIT PROGRAMMING bar code to exit Programming Mode.

For more detailed descriptions, programming information and examples for setting selected configuration items, see [References, starting on page 223](#).



## GLOBAL INTERFACE FEATURES

The following interface features are configurable by all interface types.

To set features specific to your interface, turn to that section of this manual.

### Host Commands — Obey/Ignore

This option specifies whether the reader will obey or ignore host commands. When set to ignore, the reader will ignore all host commands except those necessary for:

- service mode
- flash programming mode
- keeping the interface active
- transmission of labels.



★ Host Commands = Obey  
(Do Not Ignore Host Commands)



Host Commands = Ignore

### USB Suspend Mode

This setting enables/disables the ability of USB interfaces to enter suspend mode.



★ USB Suspend Mode = Disable



USB Suspend Mode = Enable



# CONFIGURATION | RS-232 INTERFACE

Use the programming bar codes in this chapter if modifications to the standard RS-232 interface settings are necessary to meet your system’s requirements. Additional settings which apply to both the RS-232 and USB interfaces are available in [RS-232/USB-COM Settings](#), starting on page 27.

SECTION CONTENTS	
<b>RS-232 STANDARD SETTINGS</b> starting on page 22	
<ul style="list-style-type: none"><li>• Baud Rate</li><li>• Data Bits</li><li>• Stop Bits</li></ul>	<ul style="list-style-type: none"><li>• Parity</li><li>• Handshaking Control</li></ul>

### Standard Factory Settings

Reference [Appendix B](#), for a listing of standard factory settings.



## RS-232 STANDARD SETTINGS

### Baud Rate

Baud rate is the number of bits of data transmitted per second. Set the reader's baud rate to match the baud rate setting of the host device. With an improper baud rate setting, data may not reach the host correctly.



Baud Rate = 1200



Baud Rate = 2400



Baud Rate = 4800



★ Baud Rate = 9600



Baud Rate = 19,200



Baud Rate = 38,400



Baud Rate = 57,600



Baud Rate = 115,200



## Data Bits

This parameter allows the reader to interface with devices requiring a 7-bit or 8-bit ASCII protocol for sending and receiving data.



7 Data Bits



★ 8 Data Bits



**NOTE: Handheld and base station models support the 8-bit ASCII protocol. The 7-bit ASCII protocol support is subject to specific firmware release. If the setting is not supported, the reader will emit three short beeps upon scanning the label.**

## Stop Bits

The stop bit(s) at the end of each transmitted character marks the end of transmission of one character and prepares the receiving device for the next character in the serial data stream. The number of stop bits selected (one or two) depends on the number the receiving terminal is programmed to accommodate. Set the number of stop bits to match host device requirements..



★ 1 Stop Bit



2 Stop Bits



## Parity

This feature specifies parity required for sending and receiving data. A parity check bit is the most significant bit of each ASCII coded character. Select the parity type according to host device requirements.

- Select None when no parity bit is required.
- Select Odd parity and the parity bit value is set to 0 or 1, based on data, to ensure that an odd number of 1 bits are contained in the coded character.
- Select Even parity and the parity bit value is set to 0 or 1, based on data, to ensure that an even number of 1 bits are contained in the coded character..



★ Parity = None



Parity = Even



Parity = Odd



## Handshaking Control

The data interface consists of an RS-232 port designed to operate either with or without the hardware handshaking lines, Request to Send (RTS), and Clear to Send (CTS). Handshaking Control includes the following options:

- RTS — RTS is asserted during transmissions. CTS is ignored.
- RTS/CTS — RTS is asserted during transmissions. CTS gates transmissions.
- RTS/XON/XOFF — RTS is asserted during transmissions. CTS is ignored. XON and XOFF gate transmissions.
- RTS On/CTS — RTS is always asserted. CTS gates transmissions.
- RTS/CTS Scan Control — RTS is asserted during transmissions. CTS gates transmissions and controls enable and disable state of reader.



★ Handshaking Control = RTS



Handshaking Control = RTS/CTS



Handshaking Control = RTS/XON/XOFF



Handshaking Control = RTS On/CTS



Handshaking Control = RTS/CTS Scan Control



Handshaking Control = RTS Off

# CONFIGURATION | RS-232/USB-COM INTERFACES

## SECTION CONTENTS

- Intercharacter Delay
- Beep On ASCII BEL
- Beep On Not on File
- ACK NAK Options
- ACK Character
- NAK Character
- ACK NAK Timeout Value
- ACK NAK Retry Count
- ACK NAK Error Handling
- Indicate Transmission Failure
- Disable Character
- Enable Character

### Standard Factory Settings

Reference [Appendix B](#), for a listing of standard factory settings.



## RS-232/USB-COM SETTINGS

### Intercharacter Delay

This parameter specifies the intercharacter delay between the end of one character and the beginning of the next. The delay can be set within a range of zero (0) to 990 milliseconds in 10ms increments. A setting of zero specifies no delay. See "[Intercharacter Delay](#)" on [page 225](#) for more detailed programming instructions.



Intercharacter Delay = No Delay



Select Intercharacter Delay Setting

To configure this feature, scan the ENTER/EXIT bar code above, then the bar code at left followed by digits from the Alphanumeric characters in [Appendix D](#) representing your desired character(s). End by scanning the ENTER/EXIT bar code again.

Make a mistake? Scan the CANCEL bar code to abort and not save the entry string. You can then start again at the beginning.



CANCEL

★00 = No Intercharacter Delay



## Beep On ASCII BEL

When this parameter is enabled, the reader issues a beep when a <BEL> character is detected on the RS-232 serial line. <BEL> is issued to gain a user's attention to an illegal entry or other important event.



★ Beep On ASCII BEL = Disable



Beep On ASCII BEL = Enable

## Beep On Not on File

This option enables/disables the action of the reader to sound a three beep sequence upon receiving a Not-On-File (NOF) host command.



Beep On Not On File = Disable



★ Beep On Not On File = Enable





## ACK NAK Options

This enables/disables the ability of the reader to support the RS-232 ACK/NAK protocol. When configured, the reader and/or host sends an “ACK” when it receives data properly, and sends “NAK” when the data is in error.

Options are:

- Disable
- Enable for label transmission — The reader expects an ACK/NAK response from the host when a label is sent.
- Enable for host-command acknowledge — The reader will respond with ACK/NAK when the host sends a command.
- Enable for label transmission and host-command acknowledge



★ ACK/NAK Protocol = Disable ACK/NAK



ACK/NAK Protocol = Enable for label transmission



ACK/NAK Protocol = Enable for host-command  
acknowledge



ACK/NAK Protocol = Enable for label transmission and  
host command acknowledge



## ACK Character

This setting specifies an ASCII character or hex value to be used as the ACK character. ASCII characters or any hex value from 0 to 0xFF can be selected. See "ACK Character" on page 226 for more detailed programming instructions.



**NOTE: Setting to previously defined characters such as XON, XOFF, or host commands conflicts with normal operation of these characters. 8-bit data is not recognized when the option "Data Bits" on page 23 has been set as 7 Data Bits.**



Select ACK Character Setting

Make a mistake? Scan the CANCEL bar code to abort and not save the entry string. You can then start again at the beginning.



CANCEL

★ 0x06 'ACK' Character

## NAK Character

This setting specifies an ASCII character or hex value to be used as the NAK character. ASCII characters or any hex value from 0 to 0xFF can be selected. See "NAK Character" on page 227 for more detailed programming instructions.



**NOTE: Setting to previously defined characters such as XON, XOFF, or host commands conflicts with normal operation of these characters. 8-bit data is not recognized when the option "Data Bits" on page 23 has been set as 7 Data Bits.**



Select NAK Character Setting

Make a mistake? Scan the CANCEL bar code to abort and not save the entry string. You can then start again at the beginning.



CANCEL

★ 0x15 'NAK' Character



## ACK NAK Timeout Value

This option specifies the amount of time the reader waits for an ACK character from the host following label transmission. The selectable timeout range is 200 milliseconds to 15,000ms (15 seconds) in 200ms increments. A selection of 0 disables the timeout. See "[ACK NAK Timeout Value](#)" on page 228 for more detailed programming instructions.



Select ACK NAK Timeout Value Setting

To configure this feature, scan the ENTER/EXIT bar code above, then the bar code at left followed by digits from the Alphanumeric characters in [Appendix D](#) representing your desired character(s). End by scanning the ENTER/EXIT bar code again.

Make a mistake? Scan the CANCEL bar code to abort and not save the entry string. You can then start again at the beginning.



CANCEL

★01 ACK NAK Timeout value is 200ms

## ACK NAK Retry Count

This feature specifies the number of times the reader retries a label transmission due to a retry condition. The selectable range is from 1 to 254 retries. A selection of 0 disables the count, and a selection of 255 specifies unlimited retries. See "[ACK NAK Retry Count](#)" on page 229 for more detailed programming instructions.



Select ACK NAK Retry Count Setting

To configure this feature, scan the ENTER/EXIT bar code above, then the bar code at left followed by digits from the Alphanumeric characters in [Appendix D](#) representing your desired character(s). End by scanning the ENTER/EXIT bar code again.

Make a mistake? Scan the CANCEL bar code to abort and not save the entry string. You can then start again at the beginning.



CANCEL

★003 = 3 Retries



## ACK NAK Error Handling

This feature specifies the method the reader uses to handle receive errors detected while waiting for an ACK character from the host.

Options are:

- Ignore errors detected
- Process error as valid ACK character
- Process error as valid NAK character



★ ACK NAK Error Handling = Ignore Errors Detected



ACK NAK Error Handling = Process Error as  
Valid ACK Character



ACK NAK Error Handling = Process Error as  
Valid NAK Character

## Indicate Transmission Failure

This option enables/disables the reader's ability to sound an error beep to indicate a transmission failure while in ACK/NAK mode.



Indicate Transmission Failure = Disable Indication



★ Indicate Transmission Failure = Enable Indication



## Disable Character

Specifies the value of the RS-232 host command used to disable the reader.

ASCII characters or any hex value from 0 to 0xFF can be selected. See "Disable Character" on page 230 for more detailed programming instructions.



**Setting to previously defined characters such as XON, XOFF, or host commands conflicts with normal operation of these characters.**



Select Disable Character Setting

Make a mistake? Scan the CANCEL bar code to abort and not save the entry string. You can then start again at the beginning.



CANCEL

★ 0x44 = Disable Character is 'D'

## Enable Character

Specifies the value of the RS-232 host command used to enable the reader.

ASCII characters or any hex value from 0 to 0xFF can be selected. See "Enable Character" on page 231 for more detailed programming instructions



**Setting to previously defined characters such as XON, XOFF, or host commands conflicts with normal operation of these characters.**



Select Enable Character Setting

Make a mistake? Scan the CANCEL bar code to abort and not save the entry string. You can then start again at the beginning.



CANCEL

★ 0x45 = Enable Character is 'E'

# CONFIGURATION | KEYBOARD INTERFACE

## SECTION CONTENTS

### **COUNTRY MODE** starting on page 35

- Setting Country Mode

### **OTHER KEYBOARD PARAMETERS** starting on page 50

- Encoding Type
- ALT Output Type
- Caps Lock State
- Numlock
- Keyboard Numeric Keypad
- Keyboard Send Control Characters
- Wedge Quiet Interval
- Intercharacter Delay
- Intercode Delay
- USB Keyboard Speed

Use the programming bar codes in this chapter to select options for USB Keyboard and Wedge Interfaces. Reference [Appendix B](#), for a listing of standard factory settings. Information about control character emulation which applies to keyboard interfaces is listed in [Appendix E](#), Scancode Tables.

## COUNTRY MODE

This feature specifies the country/language supported by the keyboard.

The Country Mode setting is ignored if the interface uses alternate key encoding.

## SETUP ON PC TO USE ALT UNIVERSAL

1. Open Registry Edit

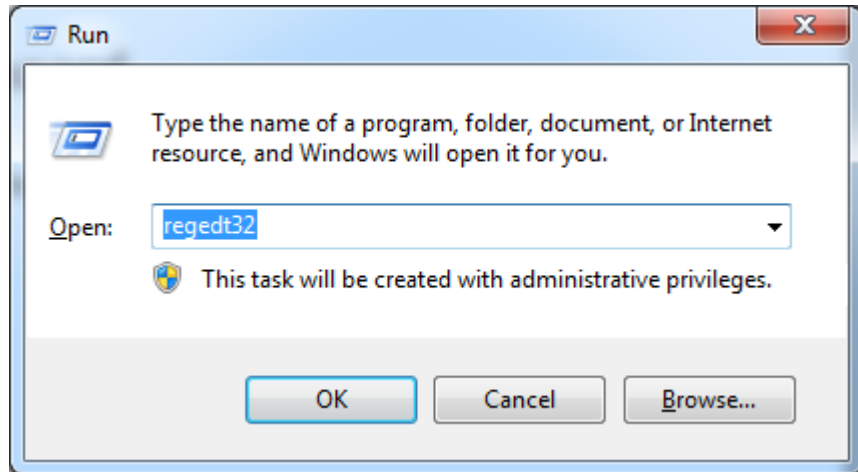

2. Set EnableHexNumpad to 1 as follows:

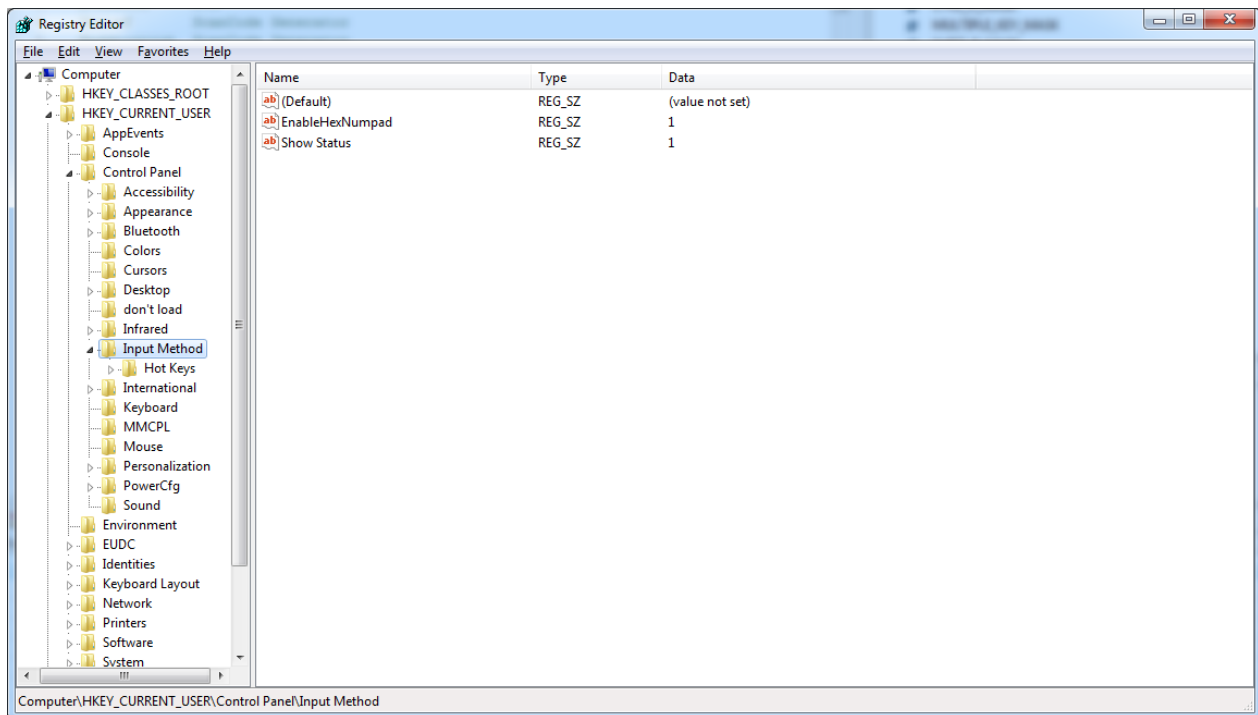

3. Reset the PC.



## Setting Country Mode



★ United States



French International (Belgian French)



United Kingdom



Danish



French (France)



German



Italian





### Setting Country Mode (continued)



Norwegian



Portuguese (Portugal)



Spanish



Swedish



Swiss French



Japanese ASCII



Hungarian



### Setting Country Mode (continued)



Czech



Slovak



Romanian



Croatian



Polish\_214



French Canadian Win7



Lithuanian



### Setting Country Mode (continued)



Vietnamese



Russian



Arabic 101



Chinese ASCII



Thai-Kedmanee



Albanian



Arabic 102



### Setting Country Mode (continued)



Arabic 102 AZERTY



Azeri Cyrillic



Azeri Latin



Belarusian



Bosnian Cyrillic



Bosnian Latin



Bulgarian Cyrillic



### Setting Country Mode (continued)



Bulgarian Latin



Canadian French (Legacy)



Canadian Multilingual



Chinese (Simplified)



Chinese (Traditional)



Czech Programmers



Czech QWERTY



### Setting Country Mode (continued)



Dutch Netherland



Estonian



Faeroese



Finnish



French (Canada) 2000/XP



French (Canada) 95/98



Galician



### Setting Country Mode (continued)



Greek



Greek Latin



Greek Polytonic



Greek220



Greek220 Latin



Greek319



Greek319 Latin



### Setting Country Mode (continued)



Hebrew Israel



Hungarian\_101KEY



Icelandic



Irish



Italian\_142



Japanese (Shift-JIS)



Kazakh





### Setting Country Mode (continued)



Korean (Hangul)



Korean ASCII



Kyrgyz Cyrillic



Latin America



Latvian



Latvian QWERTY



Lithuanian\_IBM



### Setting Country Mode (continued)



Macedonian -FYROM



Maltese\_47KEY



Mongolian-Cyrillic



Polish Programmer



Portuguese Brazil



Portuguese Brazilian ABNT



Portuguese Brazilian ABNT2



### Setting Country Mode (continued)



Romanian Legacy



Romanian Programmer



Romanian Standard



Russian Typewriter



Serbian Cyrillic



Serbian Latin



Slovak QWERTY



### Setting Country Mode (continued)



Slovenian



Spanish Variation



Swiss German



Tatar



Turkish F



Turkish Q



Ukrainian



### Setting Country Mode (continued)



US Dvorak



US Dvorak Left Hand



US Dvorak Right Hand



US English (Mac)



US English (North American)



US International



Uzbek Cyrillic



## OTHER KEYBOARD PARAMETERS

### Encoding Type



★ Encoding Type = Don't Use Encoding



Encoding Type = UTF\_8



Encoding Type = Windows 874



Encoding Type = Windows 932



Encoding Type = Windows 936



Encoding Type = Windows 949



Encoding Type = Windows 950



### Encoding Type (continued)



Encoding Type = Windows 1250



Encoding Type = Windows 1251



Encoding Type = Windows 1252



Encoding Type = Windows 1253



Encoding Type = Windows 1254



Encoding Type = Windows 1255



Encoding Type = Windows 1256



### Encoding Type (continued)



Encoding Type = Windows 1257



Encoding Type = Windows 1258



Encoding Type = Windows 20866



Encoding Type = Windows 54936



Encoding Type = ISO 8859-1



Encoding Type = ISO 8859-2



Encoding Type = ISO 8859-3





### Encoding Type (continued)



Encoding Type = ISO 8859-4



Encoding Type = ISO 8859-5



Encoding Type = ISO 8859-6



Encoding Type = ISO 8859-7



Encoding Type = ISO 8859-8



Encoding Type = ISO 8859-9



Encoding Type = ISO 8859-10



### Encoding Type (continued)



Encoding Type = ISO 8859-11



Encoding Type = ISO 8859-13



Encoding Type = ISO 8859-14



Encoding Type = ISO 8859-15



Encoding Type = ISO 8859-16



Encoding Type = MS-DOS 437



Encoding Type = MS-DOS 737



### Encoding Type (continued)



Encoding Type = MS-DOS 775



Encoding Type = MS-DOS 850



Encoding Type = MS-DOS 852



Encoding Type = MS-DOS 855



Encoding Type = MS-DOS 857



Encoding Type = MS-DOS 860



Encoding Type = MS-DOS 861



### Encoding Type (continued)



Encoding Type = MS-DOS 862



Encoding Type = MS-DOS 863



Encoding Type = MS-DOS 865



Encoding Type = MS-DOS 866



Encoding Type = MS-DOS 869



Encoding Type = Mac CP10000



## ALT Output Type

This option specifies the encode type of ALT Mode when the reader sends Output Keyboard Data in Alt Mode. (Be aware that the reader may switch automatically between ALT mode & Normal Keyboard Scancode, to correctly display some characters that are not present in the current Keyboard Country).



ALT Output Type = ALT Codepage  
(use on non Unicode application: Notepad)



★ ALT Output Type = ALT Unicode  
(use on Unicode application: Word)



ALT Output Type = ALT Universal  
(Use for all)



ALT Output Type = ALT Unicode for Linux



## Caps Lock State

This option specifies the format in which the reader sends character data. This applies to Keyboard Wedge interfaces. This does not apply when an alternate key encoding keyboard is selected. This does not apply to USB Keyboard.



★ Caps Lock State = Caps Lock OFF



Caps Lock State = Caps Lock ON



Caps Lock State = AUTO Caps Lock Enable

## Numlock

This option specifies the setting of the Numbers Lock (Numlock) key while in Keyboard Wedge interface. This only applies to alternate key encoding interfaces. It does not apply to USB Keyboard.



★ Numlock = Numlock key unchanged



Numlock = Numlock key toggled



## Keyboard Numeric Keypad

This feature specifies if numeric characters will be sent using the standard keys or the numeric keypad.



★ Keyboard Numeric Keypad = Standard Keys



Keyboard Numeric Keypad = Numeric Keypad

## Keyboard Send Control Characters

This feature is used by the Keyboard Wedge and USB Keyboard interfaces. It specifies how the reader transmits ASCII control characters to the host. Reference [Appendix E Scancode Tables](#) for more information about control characters.

Options are as follows:

**Send Ctrl+Key :** ASCII characters from 00H to 0x1FH inclusive are transmitted in the format Ctrl+Key. Special keys are available in the range from 81H to A1.

**Send Ctrl+Shift+Key :** The behavior is the same as above, but control keys are sent in the format Ctrl+Shift+Keys.

**Send Special Function Key :** Send characters between 00H and 1FH according to the special function key mapping table (see "[Interface Type PC AT PS/2 Alt Mode or USB-Keyboard Alt Mode](#)" on page 282). This is used to send keys that are not in the normal ASCII set. A unique set is provided for each available scancode set.



★ Keyboard Send Control Characters = Send Ctrl+Key



Keyboard Send Control Characters = Send Ctrl+Shift+Key



Keyboard Send Control Characters = Send Special Function  
Key



## Wedge Quiet Interval

This option specifies the amount of time to look for keyboard activity before the reader breaks the keyboard connection in order to transmit data to host. The selectable range for this feature is from 0 to 990ms in 10ms increments. See "[Wedge Quiet Interval](#)" on [page 232](#) for more detailed programming instructions.



**NOTE: This feature applies ONLY to the Keyboard Wedge interface.**



Select Wedge Quiet Interval Setting

To configure this feature, scan the ENTER/EXIT bar code above, then the bar code at left followed by digits from the Alphanumeric characters in [Appendix D](#), Keypad representing your desired character(s). End by scanning the ENTER/EXIT bar code again.

Make a mistake? Scan the CANCEL bar code to abort and not save the entry string. You can then start again at the beginning.



CANCEL

★10 = Quiet Interval of 100 msec

## Intercharacter Delay

This parameter specifies the intercharacter delay between the end of one character and the beginning of the next. The delay can be set within a range of zero (0) to 990 milliseconds in 10ms increments. A setting of zero specifies no delay. See "[Intercharacter Delay](#)" on [page 232](#) for more detailed programming instructions.



Intercharacter Delay = No Delay



Select Intercharacter Delay Setting

To configure this feature, scan the ENTER/EXIT bar code above, then the bar code at left followed by digits from the Alphanumeric characters in [Appendix D](#), Keypad representing your desired character(s). End by scanning the ENTER/EXIT bar code again.

Make a mistake? Scan the CANCEL bar code to abort and not save the entry string. You can then start again at the beginning.



CANCEL

★00 = No Intercharacter Delay





## Intercode Delay

Specifies the delay between labels transmitted to the host for this interface. The selectable range for this feature is from 0 to 99 seconds. See "[Intercode Delay](#)" on page 234 for more detailed programming instructions



Set Intercode Delay

To configure this feature, scan the ENTER/EXIT PROGRAMMING MODE bar code above, then the bar code at left followed by the digits from the Alphanumeric characters in [Appendix D, Keypad](#) representing your desired character(s). End by scanning the ENTER/EXIT bar code again.

Make a mistake? Scan the CANCEL bar code to abort and not save the entry string. You can then start again at the beginning.



CANCEL

★00 = No Wedge Intercode Delay



## USB Keyboard Speed

This option specifies the USB poll rate for a USB Keyboard.



**NOTE: This feature applies ONLY to the USB Keyboard interface.**



★ USB Keyboard Speed = 1ms



USB Keyboard Speed = 2ms



USB Keyboard Speed = 3ms



USB Keyboard Speed = 5ms



USB Keyboard Speed = 7ms



USB Keyboard Speed = 10ms

# CONFIGURATION | USB-OEM INTERFACE

SECTION CONTENTS
<ul style="list-style-type: none"><li>• USB-OEM Device Usage</li></ul>



## USB-OEM Device Usage

The USB-OEM protocol allows for the reader to be identified as one of two different types of bar code reader. Depending on what other reader you may already have connected to a USB-OEM POS, you may need to change this setting to enable all devices to communicate.

Options are:

- Tabletop Scanner
- Handheld Scanner



**NOTE: This feature is not compatible with Multiple Labels Reading in a Volume.**



USB-OEM Device Usage = Tabletop Scanner



★ USB-OEM Device Usage = Handheld Scanner

# CONFIGURATION | IBM 46XX INTERFACE

SECTION CONTENTS
<ul style="list-style-type: none"><li>• IBM 46xx Interface Options</li></ul>



## IBM 46xx Interface Options

This setting provides for an interface specific control mechanism.

Options are:

- Obey — Obey Scanner Configuration Host Commands
- Ignore — Ignore Scanner Configuration Host Commands



★ Interface Options = Obey Scanner Configuration Host Commands



Interface Options = Ignore Scanner Configuration Host Commands

# CONFIGURATION | DATA FORMAT

SECTION CONTENTS	
<b>GLOBAL SETTINGS</b> starting on page 68	
<ul style="list-style-type: none"><li>• Global Prefix/Suffix</li><li>• Case Conversion</li><li>• Character Conversion</li></ul>	<ul style="list-style-type: none"><li>• Global AIM ID</li><li>• GS1-128 AIM ID</li></ul>
<b>LABEL ID</b> starting on page 71	
<ul style="list-style-type: none"><li>• Label ID: Set Individually Per Symbology</li><li>• Label ID Control</li></ul>	<ul style="list-style-type: none"><li>• Label ID Symbology Selection</li></ul>



# GLOBAL SETTINGS

## Global Prefix/Suffix

Up to 20 ASCII characters may be added as a prefix (in a position before the bar code data) and/or as a suffix (in a position following the bar code data). See [page 236](#) in “References” for more detailed programming instructions.

To configure, scan the ENTER/EXIT PROGRAMMING MODE bar code above, then the bar code at left followed by the digits from the Alphanumeric characters in [Appendix D, Keypad](#) representing your desired character(s). End by scanning the ENTER/EXIT bar code.



Set Global Prefix



Set Global Suffix

To configure, scan the ENTER/EXIT PROGRAMMING MODE bar code above, then the bar code at left followed by the digits from the Alphanumeric characters in [Appendix D, Keypad](#) representing your desired character(s). End by scanning the ENTER/EXIT bar code.

Make a mistake? Scan the CANCEL bar code to abort and not save the entry string. You can then start again at the beginning.



CANCEL

★ No Global Prefix

★ Global Suffix = Global Suffix = 0x0D(CR)





## Case Conversion

This feature allows conversion of the case of all alphabetic characters to upper or lower case.



**NOTE: Case conversion affects ONLY scanned bar code data, and does not affect Label ID, Prefix, Suffix, or other appended data.**



★ Case Conversion = Disable (no case conversion)



Case Conversion = Convert to upper case



Case Conversion = Convert to lower case

## Character Conversion

Character conversion is an eight byte configuration item. The eight bytes are 4 character pairs represented in hexadecimal ASCII values. The first character in the pair is the character that will be converted. The second character in the pair is the character to convert to. If the character to convert in a pair is FF, then no conversion is done. See [page 242](#) in “References” for more detailed programming instructions.



Configure Character Conversion

To configure, scan the ENTER/EXIT PROGRAMMING MODE bar code above, then the bar code at left followed by the digits from the Alphanumeric characters in [Appendix D, Keypad](#) representing your desired character(s). End by scanning the ENTER/EXIT bar code.

Make a mistake? Scan the CANCEL bar code to abort and not save the entry string. You can then start again at the beginning.



CANCEL

★ 0xFFFFFFFFFFFFFFF  
(no character conversion)



## Global AIM ID



**NOTE: This feature enables/disables addition of AIM IDs for all symbology types.**

AIM label identifiers (as opposed to custom characters you select yourself as with label identifiers) can be included with scanned bar code data. See for more detailed programming instructions.



★ Global AIM ID = Disable



Global AIM ID = Enable

## GS1-128 AIM ID

If Global AIM ID is disabled, the AIM ID for GS1-128 can be enabled/disabled independently. The AIM ID for GS1-128 is a ]C1, ]C2.

AIM IDs for other symbologies can be enabled/disabled independently as well. Contact Customer Support for assistance.



Global AIM ID = Disable



★ Global AIM ID = Enable



## LABEL ID

A Label ID is a customizable code of up to three ASCII characters (each can be one of hex 0x01-0xFF), used to identify a bar code (symbology) type. It can be appended previous to or following the transmitted bar code data depending upon how this option is enabled. This feature provides options for configuring custom Label IDs as a pre-loaded set (see [Label ID: Pre-loaded Sets](#) below) or individually per symbology (see "[Label ID: Set Individually Per Symbology](#)" on page 72). If you wish to program the reader to always include an industry standard label identifier for ALL symbology types, see the previous feature "[Global AIM ID](#)" on page 70.

### Label ID: Pre-loaded Sets

The reader supports two pre-loaded sets of Label IDs, the USA set and the EU set. See "[Label ID: Pre-loaded Sets](#)" on page 238 for more information concerning the pre-loaded sets that are provided.



**CAUTION: When changing from one Label ID set to another, all other reader configuration settings, including the host interface type, will be erased and set to the factory defaults. Any custom configuration or custom defaults will be lost.**



★ Label ID Pre-loaded Set = USA Set



Label ID Pre-loaded Set = EU Set



## Label ID: Set Individually Per Symbology

This feature configures a Label ID individually for a single symbology.



**NOTE: This setting requires the scanning of bar codes from multiple sections. See "Label ID: Set Individually Per Symbology" on page 240 for more detailed programming instructions.**

## Label ID Control

This option controls whether a Label ID is disabled, or sent as a prefix or suffix for a given symbology type.



★ Label ID Transmission = Disable



Label ID Transmission = Enable as Prefix



Label ID Transmission = Enable as Suffix



## Label ID Symbology Selection

This option selects the symbology for which a Label ID is to be configured. See "[Label ID: Set Individually Per Symbology](#)" on page 240 for full instructions.

Make a mistake? Scan the CANCEL bar code to abort and not save the entry string. You can then start again at the beginning.



CANCEL



Set UPC-A Label ID Character(s)



Set UPC-A/P2 Label ID Character(s)



Set UPC-A/P5 Label ID Character(s)



Set UPC-E Label ID Character(s)



Set UPC-E/P2 Label ID Character(s)



Set UPC-E/P5 Label ID Character(s)



Set EAN-13 Label ID Character(s)



### Label ID Symbology Selection (continued)



Set EAN-13/P2 Label ID Character(s)



Set EAN-13/P5 Label ID Character(s)



Set ISBN Label ID Character(s)



Set ISSN Label ID Character(s)



Set EAN-8 Label ID Character(s)



Set EAN-8 Label ID Character(s)



Set EAN-8 Label ID Character(s)



Set GS1 DataBar Omnidirectional Label ID Character(s)



### Label ID Symbology Selection (continued)



Set GS1 DataBar Expanded Label ID Character(s)



Set GS1 DataBar Limited Label ID Character(s)



Set Code 39 Label ID Character(s)



Set Code 32 Label ID Character(s)



Set Code 39 CIP HR Label ID Character(s)



Set Code 128 Label ID Character(s)



Set Code GS1-128 Label ID Character(s)



Set Interleaved 2 of 5 Label ID Character(s)



### Label ID Symbology Selection (continued)



Set Interleaved 2 of 5 CIP HR Label ID Character(s)



Datalogic 2 of 5 Label ID Character(s)



Standard 2 of 5 Label ID Character(s)



Industrial 2 of 5 Label ID Character(s)



IATA Label ID Character(s)



Codabar Label ID Character(s)



ABC Codabar Label ID Character(s)



ISBT 128 Label ID Character(s)  
(single and concatenated)





### Label ID Symbology Selection (continued)



Code 11 Label ID Character(s)



MSI Label ID Character(s)



Plessey Label ID Character(s)



Anker Plessey Label ID Character(s)



Set Matrix 2 of 5 Label ID Character(s)

# CONFIGURATION | READING PARAMETERS

## SECTION CONTENTS

### **SCANNING FEATURES** starting on page 79

- Scan Mode
- Scanning Active Time
- Flash On Time
- Flash Off Time
- Double Read Timeout
- Stand /Base Detection Behavior
- Stand Mode/Object Detection Indication (Stand Mode Flash)
- Stand Mode/Object Detection Sensitivity
- Stand Mode/Object Detection Illumination Off Time
- Corded Stand Mode
- Dock Detection Beep

### **LED AND BEEPER INDICATORS** starting on page 87

- Power On Alert
- Good Read Beep Type
- Good Read Beep Frequency
- Good Read Beep Length
- RGB Good Read Enable
- RGB Good Read Color
- Good Read LED Duration
- Good Read Beeper Volume / Vibration
- Silent Mode
- Good Read: When to Indicate
- Green Spot Duration
- Illuminator Intensity

### **CAMERA CONTROL** starting on page 97

- Aiming Pointer
- Aiming Duration Timer
- Pick Mode
- Mobile Phone Mode
- Mobile Phone Saturation Rate
- Decode Negative Image
- Image Capture

### **MULTIPLE LABEL READING** starting on page 101

- Multiple Labels per Frame
- Multiple Labels Ordering by Code Symbology
- Multiple Labels Ordering by Code Length



## SCANNING FEATURES

### Scan Mode

Selects the reader's scan operating mode. See [page 243](#) in "References" for descriptions.



★ Scan Mode = Trigger Single



Scan Mode = Trigger Hold Multiple



Scan Mode = Trigger Pulse Multiple



Scan Mode = Flashing



Scan Mode = Always On



Scan Mode = Object Detection



Scan Mode = Trigger Object Sense



## Scanning Active Time

This setting specifies the amount of time that the reader stays in scan ON state once the state is entered. The range for this setting is from 1 to 255 seconds in 1-second increments. See [page 244](#) in “References” for further description of this feature.



Scanning Active Time = 3 seconds



★ Scanning Active Time = 5 seconds



Scanning Active Time = 8 seconds

## Flash On Time

This feature specifies the ON time for the indicator LED while in Flash Mode. The selectable range is 100 to 9,900 milliseconds (0.1 to 9.9 seconds), in 100 millisecond increments. See [page 246](#) in “References” for detailed information on setting this feature.



Select Flash ON Time Setting

To configure this feature, scan the ENTER/EXIT PROGRAMMING MODE bar code above, then the bar code at left followed by the digits from the Alphanumeric characters in [Appendix D, Keypad](#) representing your desired character(s). End by scanning the ENTER/EXIT bar code again.

Make a mistake? Scan the CANCEL bar code to abort and not save the entry string. You can then start again at the beginning.



CANCEL

★ 10 = Flash is ON for 1 Second



## Flash Off Time

This feature specifies the OFF time for the indicator LED while in Flash Mode. The selectable range is 100 to 9,900 milliseconds (0.1 to 9.9 seconds), in 100 millisecond increments. See [page 247](#) in “References” for detailed information on setting this feature.



Select Flash OFF Time Setting

To configure this feature, scan the ENTER/EXIT PROGRAMMING MODE bar code above, then the bar code at left followed by the digits from the Alphanumeric characters in [Appendix D, Keypad](#) representing your desired character(s). End by scanning the ENTER/EXIT bar code again.

Make a mistake? Scan the CANCEL bar code to abort and not save the entry string. You can then start again at the beginning.



CANCEL

★06 = Flash is OFF for 600ms

## Double Read Timeout

Double Read Timeout prevents a double read of the same label by setting the minimum time allowed between reads of labels of the same symbology and data. If the unit reads a label and sees the same label again within the specified timeout, the second read is ignored. Double Read Timeout does not apply to scan modes that require a trigger pull for each label read.



Double Read Timeout = 0.1 Second



Double Read Timeout = 0.2 Second



Double Read Timeout = 0.3 Second



Double Read Timeout = 0.4 Second



### Double Read Timeout (continued)



Double Read Timeout = 0.5 Second



★ Double Read Timeout = 0.6 Second



Double Read Timeout = 0.7 Second



Double Read Timeout = 0.8 Second



Double Read Timeout = 0.9 Second



Double Read Timeout = 1 Second



## Stand /Base Detection Behavior

Specifies the behavior of the reader when stationary in a stand. There are two conditions which cause the reader to switch to Stand Mode/Object Detection:

- The reader is configured to switch to Stand Mode/Object Detection when stationary.
- The reader is placed into the base station of the base station.

Below are further options concerning Stand Operation.

**Ignore Autorecognition:** Disables mode switching when the reader is placed in a stand.

**Switch to Stand Mode/Object Detection:** Automatically switches the reader to Stand Mode/Object Detection when the reader is placed in the stand.

**Switch to Always On:** Automatically switches the reader to Always On mode when the reader is placed in the stand.

**Switch to Flashing:** Automatically switches the reader to Flash Mode when the reader is placed in the stand.



Stand/Base Detection Behavior = Ignore Autorecognition  
(do not change behavior)



★ Stand/Base Detection Behavior =  
Switch to Stand Mode/Object Detection



Stand/Base Detection Behavior = Switch to Always On



Stand/Base Detection Behavior = Switch to Flashing



## Stand Mode/Object Detection Indication (Stand Mode Flash)

This operation is useful for indicating when the reader is in Stand Mode. If enabled, the blue indicator will blink when Stand Mode scanning is active.



★ Stand Mode/Object Detection Indication = Disable



Stand Mode/Object Detection Indication = Enable

## Stand Mode/Object Detection Sensitivity

Sets the sensitivity level for stand mode/object detection wakeup. Choices are low, medium and high.



Stand/Base Detection Sensitivity = Low



★ Stand/Base Detection Sensitivity = Medium



Stand/Base Detection Sensitivity = High





## Stand Mode/Object Detection Illumination Off Time

Specifies the amount of time reader illumination stays off after pulling the trigger when in Stand Mode/Object Detection. The configurable range is 01 to 32 by 01 in increments of 500ms (500ms to 16 seconds).



Set Illumination OFF Time

To configure, scan the ENTER/EXIT PROGRAMMING MODE bar code above, then the bar code at left followed by the digits from the Alphanumeric characters in [Appendix D, Keypad](#) representing your desired character(s). End by scanning the ENTER/EXIT bar code.

Make a mistake? Scan the CANCEL bar code to abort and not save the entry string. You can then start again at the beginning.



CANCEL

★04 = Illumination OFF Time 1 second

## Corded Stand Mode

This parameter sets the Stand Mode operation for corded models only.



★ Corded Stand Mode = Disable



Corded Stand Mode = Generic Stand



Corded Stand Mode = Permanent Stand



Corded Stand Mode = Precise Stand



## Dock Detection Beep

If enabled, when the Handheld reader is placed in a dock (base station or corded stand), it will beep.



★ Dock Detection Beep = Disable



Dock Detection Beep = Enable



## LED AND BEEPER INDICATORS

### Power On Alert

Disables or enables the indication (from the Beeper) that the reader is receiving power.



Power On Alert = Disable (No Audible Indication)



★ Power On Alert = Power-up Beep

### Good Read Beep Type

Specifies whether the good read beep has a mono or bitonal beep sound.



★ Good Read Beep Type = Mono



Good Read Beep Type = Bitonal



## Good Read Beep Frequency

Adjusts the good read beep to sound at a selectable low, medium or high frequency, selectable from the list below. (Controls the beeper's pitch/tone.)



Good Read Beep Frequency = Low



Good Read Beep Frequency = Medium



★ Good Read Beep Frequency = High



## Good Read Beep Length



Good Read Beep Length = 60 msec



★ Good Read Beep Length = 80 msec



Good Read Beep Length = 100 msec



Good Read Beep Length = 120 msec



Good Read Beep Length = 140 msec



Good Read Beep Length = 160 msec



Good Read Beep Length = 180 msec



Good Read Beep Length = 200 msec



## Good Read Beeper Volume / Vibration

Selects the beeper volume (loudness) upon a good read beep. There are three selectable volume levels.

In addition to three selectable volume levels, the user can also activate a vibration feedback for good read.



Good Read Beeper Volume = Beeper Off



Good Read Beeper Volume = Low



Good Read Beeper Volume = Medium



★ Good Read Beeper Volume = High



## Silent Mode

If needed, audible indications can be disabled by scanning the labels below.

Please note that some important audible notifications are not muted in silent mode and other notifications are replaced by vibration or visual indications.

All changes in audible notifications are summarized here:

- Good Read beep is replaced with vibration
- Power on beep is replaced with vibration
- Error beep, chirp beeps are replaced with red top LED
- Programming labels beeps are not muted



Silent Mode = Enable



★ Silent Mode = Disable

## RGB Good Read Enable

Specifies whether the RGB good read indicator is enabled or disabled.



RGB Good Read = Disable



★ RGB Good Read = Enable



## RGB Good Read Color

Selects the good read LED color.



RGB Good Read Color = RED



★ RGB Good Read Color = GREEN



RGB Good Read Color = BLUE





## Good Read LED Duration

This feature specifies the amount of time that the Good Read LED remains on following a good read. The good read LED on time can be set within a range of 100 milliseconds to 25,500 milliseconds (0.1 to 25.5 seconds) in 100ms increments. A setting of 00 keeps the LED on until the next trigger pull.

See [page 248](#) in “References” for detailed instructions and examples for setting this feature.



Select Good Read LED Duration Setting

Make a mistake? Scan the CANCEL bar code to abort and not save the entry string. You can then start again at the beginning.



Good Read LED Duration Setting =  
Keep LED on until next trigger pull

To configure this feature, scan the ENTER/EXIT PROGRAMMING MODE bar code above, then the bar code at left followed by the digits from the Alphanumeric characters in [Appendix D, Keypad](#) representing your desired character(s). End by scanning the ENTER/EXIT bar code again.



CANCEL

★ 003 = Good Read LED stays on for 300 msec.



**NOTE: Indicators are dimmed during sleep.**



## Good Read: When to Indicate

This feature specifies when the reader will provide indication (beep and/or flash its green LED) upon successfully reading a bar code.



★ Indicate Good Read = After Decode



Indicate Good Read = After Transmit



Indicate Good Read =  
After CTS goes inactive then active



## Green Spot Duration

Specifies the duration of the good read pointer beam after a good read.



Green Spot Duration = Disable (Green Spot is Off)



★ Green Spot Duration = Short (300 msec)



Green Spot Duration = Medium (500 msec)



Green Spot Duration = Long (800 msec)



## Illuminator Intensity

With the following settings the illumination intensity can be modified if needed.



Set Illumination Intensity Level = Low



Set Illumination Intensity Level = Mid-Low



Set Illumination Intensity Level = Mid



Set Illumination Intensity Level = Mid-High



★ Set Illumination Intensity Level = High



**NOTE: Increasing the Illuminator intensity level may reduce the overall reading performances.**



## CAMERA CONTROL

### Aiming Pointer

Enables/disables the aiming pointer for all symbologies.



Aiming Pointer = Disable



★ Aiming Pointer = Enable



Aiming Pointer = Green Spot

### Aiming Duration Timer

Specifies the frame of time the aiming pointer remains on after decoding a label, when in trigger single mode. The range for this setting is from 1 to 255 seconds in 1-second increments. See [page 223](#) in “References” for a description of this feature.



★ Aiming Duration Timer = Aiming Off After Decoding

To configure, scan the ENTER/EXIT PROGRAMMING MODE bar code above, then the bar code at left followed by the digits from the Alphanumeric characters in [Appendix D](#) representing your desired character(s). End by scanning the ENTER/EXIT bar code.



Aiming Duration Timer = Set Aiming Duration Timer

Make a mistake? Scan the CANCEL bar code to abort and not save the entry string. You can then start again at the beginning.



CANCEL



## Pick Mode

Specifies the ability of the reader to decode labels only when they are close to the center of the aiming pattern. This allows the reader to accurately target labels when they are placed close together, such as on a pick sheet.

The Pick Mode can be enabled only in Trigger Single Scan Mode.



**NOTE: This feature is not compatible with Multiple Labels Reading in a Volume.**



★ Pick Mode = Disable



Pick Mode = Enable

## Mobile Phone Mode

This mode is useful for scanning bar codes displayed on a mobile phone. Other options for this feature can be configured using the Datalogic Aladdin application.



Mobile Phone Mode = Disable



★ Mobile Phone Mode = Enable



Mobile Phone Mode = Enhanced



## Mobile Phone Saturation Rate

This specifies the minimum number of saturated pixels (every 1000 pixels) in the image in order to activate the Mobile Phone mode.



★ Mobile Phone Saturation Rate = 00



Mobile Phone Saturation Rate = 01



Mobile Phone Saturation Rate = 02



## Decode Negative Image

Enable/Disable the ability to decode a negative image for all symbologies. When this feature is enabled, you will be unable to read normally-printed labels or programming labels in this manual. Scan the "Disable" bar code below to return the reader to its default for this feature. To set decoding for only 2D codes, go to "2D Normal/Inverse Symbol Control" on [page 192](#). For additional options, see the Aladdin configuration application.



**NOTE:** Unlike some programming features and options, Decode Negative Image selections require that you scan only one programming bar code label. **DO NOT** scan an ENTER/EXIT bar code prior to scanning a Decode Negative Image bar code.



**CAUTION:** When this feature is enabled, you will be unable to read other programming labels in this manual.



★ Decode Negative Image = Disable



Decode Negative Image = Enable

## Image Capture

For information and a list of options for Image Capture, use the Datalogic Aladdin configuration application, available for free download from the Datalogic Scanning website.





## MULTIPLE LABEL READING

In standard (default) mode, when the reader's aiming system is activated (by a trigger pull, motion or other method depending on the mode), it then acquires and processes each image in the area in front of it (the Volume). In this case, the reader stops processing the image once it decodes a label. If several labels are present in the volume, only the first label encountered is decoded and sent.

When Multiple Reading Mode is enabled, the reader keeps on processing the image until all the labels present are decoded. The reader then sorts the data from all the bar codes (if configured to do so) before transmitting it.

### Multiple Labels per Frame

Specifies the ability of the reader to decode and transmit a set of code labels in a specific volume and in a single frame of time. When in Multiple Labels per Frame the reader beeps and turns on the good read LED indication for each code read in a frame.

When Multiple Labels Mode is enabled, ISBT pairing, ABC Codabar pairing, and composites are not allowed.



★ Multiple Labels per Frame = Disable



Multiple Labels per Frame = Enable

### Multiple Labels Ordering by Code Symbology

This feature allows you to specify the order multiple labels are transmitted by symbology type, when Multiple Labels per Frame is enabled.



Select Symbolologies for Multiple Labels Ordering

To configure, scan the ENTER/EXIT PROGRAMMING MODE bar code above, then the bar code at left followed by the digits from the Alphanumeric characters in [Appendix D, Keypad](#) representing your desired character(s). End by scanning the ENTER/EXIT bar code.

Make a mistake? Scan the CANCEL bar code to abort and not save the entry string. You can then start again at the beginning.



CANCEL

★ 000000000000 = Random order



## Multiple Labels Ordering by Code Length

Specifies the transmission ordering by code length, when Multiple Labels per Frame is enabled.



★ Multiple Labels Ordering = Disable



Multiple Labels Ordering = Transmit Increasing Length Order



Multiple Labels Ordering = Transmit Decreasing Length Order

# CONFIGURATION | 1D SYMBOLOGIES

## SECTION CONTENTS

### **DISABLE ALL SYMBOLOGIES** starting on page 104

- **COUPON CONTROL** starting on page 104
- **UPC-A** starting on page 105
- **UPC-E** starting on page 107
- **EAN-13** starting on page 110
- **EAN-8** starting on page 113
- **UPC/EAN GLOBAL SETTINGS** starting on page 115
- **GS1 DATABAR™ OMNIDIRECTIONAL** starting on page 119
- **GS1 DATABAR™ EXPANDED** starting on page 120
- **GS1 DATABAR™ LIMITED** starting on page 123
- **CODE 39** starting on page 124
- **TRIOPTIC CODE** starting on page 129
- **CODE 39 DANISH PPT** starting on page 129
- **CODE 39 PZN** starting on page 130
- **CODE 39 LA POSTE** starting on page 130
- **CODE 32 (ITALIAN PHARMACEUTICAL)** starting on page 131
- **CODE 39 CIP HR (FRENCH PHARMACEUTICAL)** starting on page 132
- **CODE 128** starting on page 133
- **GS1-128** starting on page 137
- **INTERLEAVED 2 OF 5 (I 2 OF 5)** starting on page 138
- **INTERLEAVED 2 OF 5, FEBRABAN (DESK MODELS ONLY)** starting on page 143
- **INTERLEAVED 2 OF 5 CIP HR** starting on page 144
- **MATRIX 2 OF 5** starting on page 145
- **STANDARD 2 OF 5** starting on page 148
- **COMPRESSED 2 OF 5** starting on page 151
- **DATALOGIC 2 OF 5** starting on page 154
- **INDUSTRIAL 2 OF 5** starting on page 157
- **IATA** starting on page 160
- **FOLLETT 2 OF 5** starting on page 161
- **CODABAR** starting on page 162
- **ABC CODABAR** starting on page 168
- **ISBT 128** starting on page 170
- **CODE 11** starting on page 173
- **CODE 93** starting on page 176
- **MSI** starting on page 180
- **PLESSEY** starting on page 183
- **BC412** starting on page 186



## DISABLE ALL SYMBOLOGIES

Scan this label to disable all symbologies.



Disable All Symbologies

## COUPON CONTROL

### Coupon Control

This feature is used to control the method of processing coupon labels.

Options are:

- Allow all — allow all coupon bar codes to be decoded
- Enable only UPC/EAN — enables only UPC/EAN coupon decoding
- Enable only GS1 DataBar — enables only GS1 DataBar coupon decoding

To set this feature:

1. Scan the Enter/Exit bar code.
2. Scan either the enable or disable bar code below. You'll need to cover any unused bar codes on this and the facing page to ensure that the reader sees only the bar code you intend to scan.
3. Complete the programming sequence by scanning the Enter/Exit bar code.



Coupon Control = Allow all



★ Coupon Control = Enable only UPC/EAN



Coupon Control = Enable only GS1 DataBar



## UPC-A

The following options apply to the UPC-A symbology.

### UPC-A Enable/Disable

When disabled, the reader will not read UPC-A bar codes.



UPC-A = Disable



★ UPC-A = Enable

### UPC-A Check Character Transmission

Enable this option to transmit the check character along with UPC-A bar code data.



UPC-A Check Character Transmission = Don't Send



★ UPC-A Check Character Transmission = Send



## Expand UPC-A to EAN-13

Expands UPC-A data to the EAN-13 data format. Selecting this feature also changes the symbology ID to match those required for EAN-13.



★ UPC-A to EAN-13 = Don't Expand



UPC-A to EAN-13 = Expand

## UPC-A Number System Character Transmission

This feature enables/disables transmission of the UPC-A number system character.



UPC-A Number System Character = Do not transmit



★ UPC-A Number System Character = Transmit



## UPC-E

The following options apply to the UPC-E symbology.

### UPC-E Enable/Disable

When disabled, the reader will not read UPC-E bar codes.



UPC-E = Disable



★ UPC-E = Enable

### UPC-E Check Character Transmission

Enable this option to transmit the check character along with UPC-E bar code data.



UPC-E Check Character Transmission = Don't Send



★ UPC-E Check Character Transmission = Send



## Expand UPC-E to EAN-13

Expands UPC-E data to the EAN-13 data format. Selecting this feature also changes the symbology ID to match those required for EAN-13.



★ UPC-E to EAN-13 = Don't Expand



UPC-E to EAN-13 = Expand

## Expand UPC-E to UPC-A

Expands UPC-E data to the UPC-A data format. Selecting this feature also changes the symbology ID to match those required for UPC-A.



★ UPC-E to UPC-A = Don't Expand



UPC-E to UPC-A = Expand

## UPC-E Number System Character Transmission

This feature enables/disables transmission of the UPC-E number system character.



UPC-E Number System Character = Do not transmit



★ UPC-E Number System Character = Transmit





## GTIN Formatting

This feature enables/disables the ability to convert UPC-E, UPC-A, EAN-8, and EAN-13 labels into the GTIN 14-character format.



★ GTIN Formatting = Disable



GTIN Formatting = Enable



## EAN-13

The following options apply to the EAN-13 symbology.

### EAN-13 Enable/Disable

When disabled, the reader will not read EAN-13 bar codes.



EAN-13 = Disable



★ EAN-13 = Enable

### EAN-13 Check Character Transmission

Enable this option to transmit the check character along with EAN-13 bar code data.



EAN-13 Check Character Transmission = Don't Send



★ EAN-13 Check Character Transmission = Send



## EAN-13 Flag 1 Character

Enables/disables transmission of an EAN/JAN-13 Flag1 character. The Flag 1 character is the first character of the label



EAN-13 Flag 1 Char = Don't transmit



★ EAN-13 Flag 1 Char = Transmit

## EAN-13 to ISBN Conversion

This option enables/disables conversion of EAN-13/JAN-13 Bookland labels starting with 978 to ISBN labels.



★ EAN-13 ISBN Conversion = Disable



EAN-13 ISBN Conversion = Enable



## EAN-13 to ISSN Conversion

Enables/disables conversion of EAN/JAN-13 Bookland labels starting with 977 to ISSN labels.



★ ISSN = Disable



ISSN = Enable



## EAN-8

The following options apply to the EAN-8 symbology.

### EAN-8 Enable/Disable

When disabled, the reader will not read EAN-8 bar codes.



EAN-8 = Disable



★ EAN-8 = Enable

### EAN-8 Check Character Transmission

Enable this option to transmit the check character along with EAN-8 bar code data.



EAN-8 Check Character Transmission = Don't Send



★ EAN-8 Check Character Transmission = Send



## Expand EAN-8 to EAN-13

Enable this option to expand EAN-8/JAN-8 labels to EAN-13/JAN-13.



★ EAN-8 to EAN-13 = Don't Expand



EAN-8 to EAN-13 = Expand



## UPC/EAN GLOBAL SETTINGS

This section provides configuration settings for UPC-A, UPC-E, EAN 13 and EAN 8 symbologies, and affects all of these unless otherwise marked for each feature description.

### UPC/EAN Price Weight Check

This feature enables/disables calculation and verification of price/weight check digits.

Options are

- Disabled
- Enable 4-digit price-weight check-digit calculation
- Enable 5-digit price-weight check-digit calculation
- Enable European 4-digit price-weight check-digit calculation
- Enable European 5-digit price-weight check-digit calculation



★ Price Weight Check = Disable



Price Weight Check = 4-digit price-weight check



Price Weight Check = 5-digit price-weight check



Price Weight Check = European 4-digit price-weight check



Price Weight Check = European 5-digit price-weight check



## UPC/EAN Quiet Zones

This feature specifies the number of quiet zones for UPC/EAN labels. Quiet zones are blank areas at the ends of a bar code, typically 10 times the width of the narrowest bar or space in the label. The property applies to all EAN-UPC symbologies globally and to the ADD-ONS.



★ UPC/EAN Quiet Zones = Two Modules



UPC/EAN Quiet Zones = Three Modules

## Add-Ons

The following features apply to optional add-ons.



**NOTE: Contact Customer Support for advanced programming of optional and conditional add-ons.**





## Optional Add-ons

The reader can be enabled to optionally read the following add-ons (supplementals):

- P2
- P5



**NOTE: If a UPC/EAN base label and a an add-on are both decoded, the reader will transmit the base label and add-on. If a UPC/EAN base label is decoded without an add-on, the base label will be transmitted without an add-on.**

**Conditional add-on settings (if enabled) are considered by the reader before optional add-on settings.**



★ Optional Add-Ons = Disable P2



Optional Add-Ons = Enable P2



★ Optional Add-Ons = Disable P5



Optional Add-Ons = Enable P5



## Optional Add-On Timer

This option sets the time the reader will look for an add-on when an add-on fragment has been seen and optional add-ons are enabled.



Optional Add-on Timer = 10ms



Optional Add-on Timer = 20ms



Optional Add-on Timer = 30ms



Optional Add-on Timer = 50ms



★ Optional Add-on Timer = 70ms



Optional Add-on Timer = 100ms



Optional Add-on Timer = 160ms



## GS1 DATABAR™ OMNIDIRECTIONAL

The following options apply to the GS1 DataBar Omnidirectional (formerly RSS-14) symbology.

### GS1 DataBar Omnidirectional Enable/Disable

When disabled, the reader will not read GS1 DataBar Omnidirectional bar codes.



★ GS1 DataBar Omnidirectional = Disable



GS1 DataBar Omnidirectional = Enable

### GS1 DataBar Omnidirectional to GS1-128 Emulation

When enabled, GS1 DataBar Omnidirectional bar codes will be translated to the GS1-128 label data format.



★ GS1 DataBar Omnidirectional to GS1-128 Emulation  
= Disable



GS1 DataBar Omnidirectional to GS1-128 Emulation  
= Enable



## GS1 DATABAR™ EXPANDED

The following options apply to the GS1 DataBar Expanded (formerly RSS Expanded) symbology.

### GS1 DataBar Expanded Enable/Disable

When disabled, the reader will not read GS1 DataBar Expanded bar codes.



★ GS1 DataBar Expanded = Disable



GS1 DataBar Expanded = Enable

### GS1 DataBar Expanded to GS1-128 Emulation

When enabled, GS1 DataBar Expanded bar codes will be translated to the GS1-128 label data format.



★ GS1 DataBar Expanded to GS1-128 Emulation  
= Disable



GS1 DataBar Expanded to GS1-128 Emulation  
= Enable



## GS1 DataBar Expanded Length Control

This feature specifies either variable length decoding or fixed length decoding for the GS1 DataBar Expanded symbology.

**Variable Length:** For variable-length decoding, a minimum length may be set.

**Fixed Length:** For fixed-length decoding, two different lengths may be set.



★ GS1 DataBar Expanded Length Control  
= Variable Length



GS1 DataBar Expanded Length Control = Fixed Length

## GS1 DataBar Expanded Set Length 1

This feature specifies one of the bar code lengths for "GS1 DataBar Expanded Length Control" on page 121. Length 1 is the minimum label length if in Variable Length Mode, or the first fixed length if in Fixed Length Mode. Length includes the bar code's data characters only.

The length can be set from 1 to 74 characters. See "Set Length 1" on page 249 for more detailed programming instructions.



Select GS1 DataBar Expanded Set Length 1 Setting

To configure this feature, scan the ENTER/EXIT PROGRAMMING MODE bar code above, then the bar code at left followed by the digits from the Alphanumeric characters in [Appendix D, Keypad](#) representing your desired character(s). End by scanning the ENTER/EXIT bar code again.

Make a mistake? Scan the CANCEL bar code to abort and not save the entry string. You can then start again at the beginning.



CANCEL

★ Length 1 = 01 (one character)



## GS1 DataBar Expanded Set Length 2

This feature specifies one of the bar code lengths for "GS1 DataBar Expanded Length Control" on page 121. Length 2 is the maximum label length if in Variable Length Mode, or the second fixed length if in Fixed Length Mode. Length includes the bar code's data characters only.

The length can be set from 1 to 74 characters. A setting of 00 specifies to ignore this length (only one fixed length). See "Set Length 2" on page 250 for more detailed programming instructions.



Select GS1 DataBar Expanded Set Length 2 Setting

To configure this feature, scan the ENTER/EXIT PROGRAMMING MODE bar code above, then the bar code at left followed by the digits from the Alphanumeric characters in Appendix D, Keypad representing your desired character(s). End by scanning the ENTER/EXIT bar code again.

Make a mistake? Scan the CANCEL bar code to abort and not save the entry string. You can then start again at the beginning.



CANCEL

★ Length 2 = 74 (74 characters)



## GS1 DATABAR™ LIMITED

The following options apply to the GS1 DataBar Limited (formerly RSS Limited) symbology.

### GS1 DataBar Limited Enable/Disable

When disabled, the reader will not read GS1 DataBar Limited bar codes.



★ GS1 DataBar Limited = Disable



GS1 DataBar Limited = Enable

### GS1 DataBar Limited to GS1-128 Emulation

When enabled, GS1 DataBar Limited bar codes will be translated to the GS1-128 label data format.



★ GS1 DataBar Limited to GS1-128 Emulation = Disable



GS1 DataBar Limited to GS1-128 Emulation = Enable



## CODE 39

The following options apply to the Code 39 symbology.

### Code 39 Enable/Disable

When disabled, the reader will not read Code 39 bar codes.



Code 39 = Disable



★ Code 39 = Enable

### Code 39 Check Character Calculation

Enable this option to enable/disable calculation and verification of an optional Code 39 check character. When disabled, any check character in the label is treated as a data character.



★ Code 39 Check Character Calculation = Don't Calculate



Code 39 Check Character Calculation = Calculate Std Check



Code 39 Check Character Calculation = Calculate Mod 7 Check



Code 39 Check Character Calculation = Enable Italian Post Check





Code 39 Check Character Calculation = Enable Daimler  
Chrysler Check

## Code 39 Check Character Transmission

Enable this option to transmit the check character along with Code 39 bar code data.



Code 39 Check Character Transmission = Don't Send



★ Code 39 Check Character Transmission = Send

## Code 39 Start/Stop Character Transmission

Enable this option to enable/disable transmission of Code 39 start and stop characters.



★ Code 39 Start/Stop Character Transmission  
= Don't Transmit



Code 39 Start/Stop Character Transmission  
= Transmit



## Code 39 Full ASCII

In Code 39 decoding, this enables/disables the translation of Code 39 characters to Code 39 full-ASCII characters.



★ Code 39 Full ASCII = Disable



Code 39 Full ASCII = Enable

## Code 39 Quiet Zones

This feature specifies the number of quiet zones for Code 39 labels. Quiet zones are blank areas at the ends of a bar code and are typically 10 times the width of the narrowest bar or space in the label.



Code 39 Quiet Zones = Quiet Zone on one side



Code 39 Quiet Zones = Quiet Zones on two sides



Code 39 Quiet Zones = Auto



Code 39 Quiet Zones = Virtual Quiet Zones on two sides



★ Code 39 Quiet Zones =  
Small Quiet Zones on two sides



## Code 39 Length Control

This feature specifies either variable length decoding or fixed length decoding for the Code 39 symbology.

**Variable Length:** For variable-length decoding, a minimum length may be set.

**Fixed Length:** For fixed-length decoding, two different lengths may be set.



★ Code 39 Length Control  
= Variable Length



Code 39 Length Control = Fixed Length

## Code 39 Set Length 1

This feature specifies one of the bar code lengths for "[Code 39 Length Control](#)" on [page 127](#). Length 1 is the minimum label length if in Variable Length Mode, or the first fixed length if in Fixed Length Mode. Length includes the bar code's check, data, and full-ASCII shift characters. The length does not include start/stop characters.

The length can be set from 0 to 50 characters. See "[Set Length 1](#)" on [page 249](#) for more detailed programming instructions.



Select Code 39 Set Length 1 Setting

To configure this feature, scan the ENTER/EXIT PROGRAMMING MODE bar code above, then the bar code at left followed by the digits from the Alphanumeric characters in [Appendix D, Keypad](#) representing your desired character(s). End by scanning the ENTER/EXIT bar code again.

Make a mistake? Scan the CANCEL bar code to abort and not save the entry string. You can then start again at the beginning.



CANCEL

★ Length 1 = 02 (2 characters)



## Code 39 Set Length 2

This feature specifies one of the bar code lengths for "[Code 39 Length Control](#)" on page 127. Length 2 is the maximum label length if in Variable Length Mode, or the second fixed length if in Fixed Length Mode. Length includes the bar code's check, data, and full-ASCII shift characters. The length does not include start/stop characters.

The length can be set from 1 to 50 characters. A setting of 00 specifies to ignore this length (only one fixed length). See "[Set Length 2](#)" on page 250 for more detailed programming instructions.



Select Code 39 Set Length 2 Setting

To configure this feature, scan the ENTER/EXIT PROGRAMMING MODE bar code above, then the bar code at left followed by the digits from the Alphanumeric characters in [Appendix D, Keypad](#) representing your desired character(s). End by scanning the ENTER/EXIT bar code again.

Make a mistake? Scan the CANCEL bar code to abort and not save the entry string. You can then start again at the beginning.



CANCEL

★ Length 2 = 50 (50 characters)



## TRIOPTIC CODE

The following options apply to the trioptic symbology.

### Trioptic Code Enable/Disable

When disabled, the reader will not read Trioptic Code bar codes.



★ Trioptic Code = Disable



Trioptic Code = Enable

## CODE 39 DANISH PPT

The following options apply to the Code 39 Danish PPT symbology.

### Code 39 Danish PPT Enable/Disable

When disabled, the reader will not read Code 39 Danish PPT bar codes.



★ Code 39 Danish PPT = Disable



Code 39 Danish PPT = Enable



## CODE 39 PZN

The following options apply to the Code 39 PZN symbology.

### Code 39 PZN Enable/Disable

When disabled, the reader will not read Code 39 PZN bar codes.



★ Code 39 PZN = Disable



Code 39 PZN = Enable

## CODE 39 LA POSTE

The following options apply to the Code 39 La Poste symbology.

### Code 39 La Poste Enable/Disable

When disabled, the reader will not read Code 39 La Poste bar codes.



★ Code 39 La Poste = Disable



Code 39 La Poste = Enable



## CODE 32 (ITALIAN PHARMACEUTICAL)

The following options apply to the Code 32 symbology.

### Code 32 Enable/Disable

When disabled, the reader will not read Code 32 bar codes.



★ Code 32 = Disable



Code 32 = Enable

### Code 32 Feature Setting Exceptions



**NOTE: The following features are set for Code 32 by using these Code 39 settings:**

"Code 39 Quiet Zones" on page 126

"Code 39 Length Control" on page 127

### Code 32 Check Character Transmission

Enable this option to transmit the check character along with Code 32 bar code data.



★ Code 32 Check Character Transmission = Don't  
Send



Code 32 Check Character Transmission = Send



## Code 32 Start/Stop Character Transmission

Enable this option to enable/disable transmission of Code 32 start and stop characters.



★ Code 32 Start/Stop Character Transmission  
= Don't Transmit



Code 32 Start/Stop Character Transmission  
= Transmit

## CODE 39 CIP HR (FRENCH PHARMACEUTICAL)

The following options apply to the Code 39 CIP HR symbology.

### Code 39 CIP HR Enable/Disable

Enables/Disables ability of the reader to decode Code 39 CIP HR labels.



★ Code 39 CIP HR = Disable



Code 39 CIP HR = Enable





## CODE 128

The following options apply to the Code 128 symbology.

### Code 128 Enable/Disable

Enables/Disables ability of the reader to decode Code 128 labels.



Code 128 = Disable



★ Code 128 = Enable

### Expand Code 128 to Code 39

This feature enables/disables expansion of Code 128 labels to Code 39 labels. When enabled, the label identifier for a Code 128 label shall be set to Code 39 and all Code 39 formatting control shall be applied to the label.



★ Code 128 to Code 39 = Don't Expand



Code 128 to Code 39 = Expand



## Code 128 Check Character Transmission

Enable this option to transmit the check character along with Code 128 bar code data.



★ Code 128 Check Character Transmission =  
Don't Send



Code 128 Check Character Transmission = Send

## Code 128 Function Character Transmission

Enables/disables transmission of Code128 function characters 1, 2, 3, and 4.



★ Code 128 Function Character Transmission =  
Don't Send



Code 128 Function Character Transmission = Send



## Code 128 Quiet Zones

This feature specifies the number of quiet zones for Code 128 labels. Quiet zones are blank areas at the ends of a bar code and are typically 10 times the width of the narrowest bar or space in the label.



Code 128 Quiet Zones = No Quiet Zones



Code 128 Quiet Zones = Quiet Zone on one side



Code 128 Quiet Zones = Quiet Zones on two sides



★ Code 128 Quiet Zones = Auto



Code 128 Quiet Zones = Virtual Quiet Zones on two sides

## Code 128 Length Control

This feature specifies either variable length decoding or fixed length decoding for the Code 128 symbology.

**Variable Length:** For variable-length decoding, a minimum length may be set.

**Fixed Length:** For fixed-length decoding, two different lengths may be set.



★ Code 128 Length Control = Variable Length



Code 128 Length Control = Fixed Length



## Code 128 Set Length 1

This feature specifies one of the bar code lengths for "Code 128 Length Control" on page 135. Length 1 is the minimum label length if in Variable Length Mode, or the first fixed length if in Fixed Length Mode. Length includes the bar code's data characters only.

The length can be set from 1 to 80 characters. See "Set Length 1" on page 249 for more detailed programming instructions.



Select Code 128 Set Length 1 Setting

To configure this feature, scan the ENTER/EXIT PROGRAMMING MODE bar code above, then the bar code at left followed by the digits from the Alphanumeric characters in Appendix D, Keypad representing your desired character(s). End by scanning the ENTER/EXIT bar code again.

Make a mistake? Scan the CANCEL bar code to abort and not save the entry string. You can then start again at the beginning.



CANCEL

★ Length 1 = 01 (one character)

## Code 128 Set Length 2

This feature specifies one of the bar code lengths for "Code 128 Length Control" on page 135. Length 2 is the maximum label length if in Variable Length Mode, or the second fixed length if in Fixed Length Mode. Length includes the bar code's data characters only.

The length can be set from 1 to 80 characters. A setting of 00 specifies to ignore this length (only one fixed length). See "Set Length 2" on page 250 for more detailed programming instructions.



Select Code 128 Set Length 2 Setting

To configure this feature, scan the ENTER/EXIT PROGRAMMING MODE bar code above, then the bar code at left followed by the digits from the Alphanumeric characters in Appendix D, Keypad representing your desired character(s). End by scanning the ENTER/EXIT bar code again.

Make a mistake? Scan the CANCEL bar code to abort and not save the entry string. You can then start again at the beginning.



CANCEL

★ Length 2 = 80 (80 characters)



## GS1-128

The following options apply to the GS1-128 symbology. (Also known as USS-128, GTIN-128, UCC-128.)

### GS1-128 Enable

This option enables/disables the ability of the reader to translate GS1-128 labels to the GS1-128 data format. Options are:

- Transmit GS1-128 labels in Code 128 data format.
- Transmit GS1-128 labels in GS1-128 data format.
- Do not transmit GS1-128 labels.



GS1-128 = Transmit in Code 128 data format



★ GS1-128 = Transmit in GS1-128 data format



GS1-128 = Do not transmit GS1-128 labels



## INTERLEAVED 2 OF 5 (I 2 OF 5)

The following options apply to the I 2 of 5 symbology.



**CAUTION: When reading this symbology, the settings for I 2 of 5 Length Control AND I 2 of 5 Check Character Calculation MUST be enabled to increase decoding safety.**

### I 2 of 5 Enable/Disable

When disabled, the reader will not read I 2 of 5 bar codes.



★ I 2 of 5 = Disable



I 2 of 5 = Enable



## I 2 of 5 Check Character Calculation

This option enables/disables calculation and verification of an optional I 2 of 5 check character.



★ I 2 of 5 Check Character Calculation = Disable



I 2 of 5 Check Character Calculation  
= Calculate Std Check (Modulo 10 no AR)



I 2 of 5 Check Character Calculation  
= Calculate German Parcel Check



I 2 of 5 Check Character Calculation  
= Calculate DHL Check



I 2 of 5 Check Character Calculation  
= Calculate Daimler Chrysler Check



## I 2 of 5 Check Character Calculation (continued)



I 2 of 5 Check Character Calculation  
= Calculate Bosch Check



I 2 of 5 Check Character Calculation  
= Calculate Italian Post Check

## I 2 of 5 Check Character Transmission

Enable this option to transmit the check character along with I 2 of 5 bar code data.



**NOTE: This feature is valid only when I 2 of 5 Check Character Calculation is enabled.**



I 2 of 5 Check Character Transmission = Don't Send



★ I 2 of 5 Check Character Transmission = Send





## I 2 of 5 Length Control

This feature specifies either variable length decoding or fixed length decoding for the I 2 of 5 symbology.

**Variable Length:** For variable-length decoding, a minimum length may be set.

**Fixed Length:** For fixed-length decoding, two different lengths may be set.



★ I 2 of 5 Length Control = Variable Length



I 2 of 5 Length Control = Fixed Length

## I 2 of 5 Set Length 1

This feature specifies one of the bar code lengths for "I 2 of 5 Length Control" on page 141. Length 1 is the minimum label length if in Variable Length Mode, or the first fixed length if in Fixed Length Mode. The length includes the bar code's check and data characters. The length can be set from 2 to 50 characters in increments of two. See "Set Length 1" on page 249 for more detailed programming instructions.



Select I 2 of 5 Set Length 1 Setting

To configure this feature, scan the ENTER/EXIT PROGRAMMING MODE bar code above, then the bar code at left followed by the digits from the Alphanumeric characters in [Appendix D, Keypad](#) representing your desired character(s). End by scanning the ENTER/EXIT bar code again.

Make a mistake? Scan the CANCEL bar code to abort and not save the entry string. You can then start again at the beginning.



CANCEL

★ Length 1 = 06 (6 characters)



## I 2 of 5 Set Length 2

This feature specifies one of the bar code lengths for "I 2 of 5 Length Control" on page 141. Length 2 is the maximum label length if in Variable Length Mode, or the second fixed length if in Fixed Length Mode. The length includes the bar code's check and data characters. The length can be set from 2 to 50 characters in increments of two. A setting of 00 specifies to ignore this length (only one fixed length). See "Set Length 2" on page 250 for more detailed programming instructions.



Select I 2 of 5 Set Length 2 Setting

To configure this feature, scan the ENTER/EXIT PROGRAMMING MODE bar code above, then the bar code at left followed by the digits from the Alphanumeric characters in [Appendix D, Keypad](#) representing your desired character(s). End by scanning the ENTER/EXIT bar code again.

Make a mistake? Scan the CANCEL bar code to abort and not save the entry string. You can then start again at the beginning.



CANCEL

★ Length 2 = 50 (50 characters)



## INTERLEAVED 2 OF 5, FEBRABAN (DESK MODELS ONLY)

### Interleaved 2 of 5, Febraban format Enable / Disable



**NOTE: Interleaved 2 of 5 shall be enabled before enabling Febraban variant.**

Enables/Disables ability of reader to decode Interleaved 2 of 5, Febraban format.



★ 2 of 5, Febraban format = Disable



2 of 5, Febraban format = Enable



## INTERLEAVED 2 OF 5 CIP HR

The following options apply to the Interleaved 2 of 5 CIP HR symbology.

### Interleaved 2 of 5 CIP HR Enable/Disable

Enables/Disables ability of the reader to decode Interleaved 2 of 5 CIP HR labels.



★ Interleaved 2 of 5 CIP HR = Disable



Interleaved 2 of 5 CIP HR = Enable



## MATRIX 2 OF 5

The following options apply to the Matrix 2 of 5 symbology.

### Matrix 2 of 5 Enable/Disable

When disabled, the reader will not read Matrix 2 of 5 bar codes.



★ Matrix 2 of 5 = Disable



Matrix 2 of 5 = Enable

### Matrix 2 of 5 Check Character Calculation

This option enables/disables calculation and verification of an optional Matrix 2 of 5 check character.



★ Matrix 2 of 5 Check Character Calculation  
= Disable



Matrix 2 of 5 Check Character Calculation = Enable



## Matrix 2 of 5 Check Character Transmission

This feature enables/disables transmission of an optional Matrix 2 of 5 check character.



Matrix 2 of 5 Check Character Transmission  
= Don't Send



★ Matrix 2 of 5 Check Character Transmission  
= Send

## Matrix 2 of 5 Length Control

This feature specifies either variable length decoding or fixed length decoding for the Matrix 2 of 5 symbology.

**Variable Length:** For variable-length decoding, a minimum length may be set.

**Fixed Length:** For fixed-length decoding, two different lengths may be set.



★ Matrix 2 of 5 Length Control = Variable Length



Matrix 2 of 5 Length Control = Fixed Length



## Matrix 2 of 5 Set Length 1

This feature specifies one of the bar code lengths for "Standard 2 of 5 Length Control" on [page 149](#). Length 1 is the minimum label length if in Variable Length Mode, or the first fixed length if in Fixed Length Mode. The length includes the bar code's check and data characters.

The length can be set from 1 to 50 characters. See "Set Length 1" on [page 249](#) for more detailed programming instructions.



Select Matrix 2 of 5 Length 1 Setting

To configure this feature, scan the ENTER/EXIT PROGRAMMING MODE bar code above, then the bar code at left followed by the digits from the Alphanumeric characters in [Appendix D, Keypad](#) representing your desired character(s). End by scanning the ENTER/EXIT bar code again.

Make a mistake? Scan the CANCEL bar code to abort and not save the entry string. You can then start again at the beginning.



CANCEL

★ Length 1 = 08 (8 characters)

## Matrix 2 of 5 Set Length 2

This feature specifies one of the bar code lengths for "Standard 2 of 5 Length Control" on [page 149](#). Length 2 is the maximum label length if in Variable Length Mode, or the second fixed length if in Fixed Length Mode. The length includes the bar code's check and data characters.

The length can be set from 1 to 50 characters. A setting of 00 specifies to ignore this length (only one fixed length). See "Set Length 2" on [page 250](#) for more detailed programming instructions.



Select Matrix 2 of 5 Set Length 2 Setting

To configure this feature, scan the ENTER/EXIT PROGRAMMING MODE bar code above, then the bar code at left followed by the digits from the Alphanumeric characters in [Appendix D, Keypad](#) representing your desired character(s). End by scanning the ENTER/EXIT bar code again.

Make a mistake? Scan the CANCEL bar code to abort and not save the entry string. You can then start again at the beginning.



CANCEL

★ Length 2 = 50 (50 characters)



## STANDARD 2 OF 5

The following options apply to the Standard 2 of 5 symbology.

### Standard 2 of 5 Enable/Disable

When disabled, the reader will not read Standard 2 of 5 bar codes.



★ Standard 2 of 5 = Disable



Standard 2 of 5 = Enable

### Standard 2 of 5 Check Character Calculation

This option enables/disables calculation and verification of an optional Standard 2 of 5 check character.



★ Standard 2 of 5 Check Character Calculation  
= Disable



Standard 2 of 5 Check Character Calculation = Enable





## Standard 2 of 5 Check Character Transmission

This feature enables/disables transmission of an optional Standard 2 of 5 check character.



Standard 2 of 5 Check Character Transmission  
= Don't Send



★ Standard 2 of 5 Check Character Transmission  
= Send

## Standard 2 of 5 Length Control

This feature specifies either variable length decoding or fixed length decoding for the Standard 2 of 5 symbology.

**Variable Length:** For variable-length decoding, a minimum length may be set.

**Fixed Length:** For fixed-length decoding, two different lengths may be set.



★ Standard 2 of 5 Length Control = Variable Length



Standard 2 of 5 Length Control = Fixed Length



## Standard 2 of 5 Set Length 1

This feature specifies one of the bar code lengths for "Standard 2 of 5 Length Control" on page 149. Length 1 is the minimum label length if in Variable Length Mode, or the first fixed length if in Fixed Length Mode. The length includes the bar code's check and data characters.

The length can be set from 1 to 50 characters. See "Set Length 1" on page 249 for more detailed programming instructions.



Select Standard 2 of 5 Length 1 Setting

To configure this feature, scan the ENTER/EXIT PROGRAMMING MODE bar code above, then the bar code at left followed by the digits from the Alphanumeric characters in Appendix D, Keypad representing your desired character(s). End by scanning the ENTER/EXIT bar code again.

Make a mistake? Scan the CANCEL bar code to abort and not save the entry string. You can then start again at the beginning.



CANCEL

★ Length 1 = 08 (8 characters)

## Standard 2 of 5 Set Length 2

This feature specifies one of the bar code lengths for "Standard 2 of 5 Length Control" on page 149. Length 2 is the maximum label length if in Variable Length Mode, or the second fixed length if in Fixed Length Mode. The length includes the bar code's check and data characters.

The length can be set from 1 to 50 characters. A setting of 00 specifies to ignore this length (only one fixed length). See "Set Length 2" on page 250 for more detailed programming instructions.



Select Standard 2 of 5 Set Length 2 Setting

To configure this feature, scan the ENTER/EXIT PROGRAMMING MODE bar code above, then the bar code at left followed by the digits from the Alphanumeric characters in Appendix D, Keypad representing your desired character(s). End by scanning the ENTER/EXIT bar code again.

Make a mistake? Scan the CANCEL bar code to abort and not save the entry string. You can then start again at the beginning.



CANCEL

★ Length 2 = 50 (50 characters)



## COMPRESSED 2 OF 5

The following options apply to the Compressed 2 of 5 symbology.

### Compressed 2 of 5 Enable/Disable

When disabled, the reader will not read Compressed 2 of 5 bar codes.



★ Compressed 2 of 5 = Disable



Compressed 2 of 5 = Enable

### Compressed 2 of 5 Check Character Calculation

This option enables/disables calculation and verification of an optional Compressed 2 of 5 check character.



★ Compressed 2 of 5 Check Character Calculation  
= Disable



Compressed 2 of 5 Check Character Calculation = Enable



## Compressed 2 of 5 Check Character Transmission

This feature enables/disables transmission of an optional Compressed 2 of 5 check character.



Compressed 2 of 5 Check Character Transmission  
= Don't Send



★ Compressed 2 of 5 Check Character Transmission  
= Send

## Compressed 2 of 5 Length Control

This feature specifies either variable length decoding or fixed length decoding for the Compressed 2 of 5 symbology.

**Variable Length:** For variable-length decoding, a minimum length may be set.

**Fixed Length:** For fixed-length decoding, two different lengths may be set.



★ Compressed 2 of 5 Length Control = Variable  
Length



Compressed 2 of 5 Length Control = Fixed Length



## Compressed 2 of 5 Set Length 1

This feature specifies one of the bar code lengths for "[Compressed 2 of 5 Length Control](#)" on page 152. Length 1 is the minimum label length if in Variable Length Mode, or the first fixed length if in Fixed Length Mode. The length includes the bar code's check and data characters.

The length can be set from 1 to 50 characters. See "[Set Length 1](#)" on page 249 for more detailed programming instructions.



Select Compressed 2 of 5 Length 1 Setting

To configure this feature, scan the ENTER/EXIT PROGRAMMING MODE bar code above, then the bar code at left followed by the digits from the Alphanumeric characters in [Appendix D, Keypad](#) representing your desired character(s). End by scanning the ENTER/EXIT bar code again.

Make a mistake? Scan the CANCEL bar code to abort and not save the entry string. You can then start again at the beginning.



CANCEL

★ Length 1 = 01 (one character)

## Compressed 2 of 5 Set Length 2

This feature specifies one of the bar code lengths for "[Compressed 2 of 5 Length Control](#)" on page 152. Length 2 is the maximum label length if in Variable Length Mode, or the second fixed length if in Fixed Length Mode. The length includes the bar code's check and data characters.

The length can be set from 1 to 50 characters. A setting of 00 specifies to ignore this length (only one fixed length). See "[Set Length 2](#)" on page 250 for more detailed programming instructions.



Select Compressed 2 of 5 Set Length 2 Setting

To configure this feature, scan the ENTER/EXIT PROGRAMMING MODE bar code above, then the bar code at left followed by the digits from the Alphanumeric characters in [Appendix D, Keypad](#) representing your desired character(s). End by scanning the ENTER/EXIT bar code again.

Make a mistake? Scan the CANCEL bar code to abort and not save the entry string. You can then start again at the beginning.



CANCEL

★ Length 2 = 50 (50 characters)



## DATALOGIC 2 OF 5

The following options apply to the Datalogic 2 of 5 symbology.

### Datalogic 2 of 5 Enable/Disable

When disabled, the reader will not read Datalogic 2 of 5 bar codes.



★ Datalogic 2 of 5 = Disable



Datalogic 2 of 5 = Enable

### Datalogic 2 of 5 Check Character Calculation

This option enables/disables calculation and verification of an optional Datalogic 2 of 5 check character.



★ Datalogic 2 of 5 Check Character Calculation  
= Disable



Datalogic 2 of 5 Check Character Calculation = Enable



## Datalogic 2 of 5 Check Character Transmission

Enable this option to transmit the check character along with Datalogic 2 of 5 bar code data.



Datalogic 2 of 5 Check Character Transmission  
= Don't Send



★ Datalogic 2 of 5 Check Character Transmission  
= Send

## Datalogic 2 of 5 Length Control

This feature specifies either variable length decoding or fixed length decoding for the Datalogic 2 of 5 symbology.

**Variable Length:** For variable-length decoding, a minimum length may be set.

**Fixed Length:** For fixed-length decoding, two different lengths may be set.



★ Datalogic 2 of 5 Length Control = Variable Length



Datalogic 2 of 5 Length Control = Fixed Length



## Datalogic 2 of 5 Set Length 1

This feature specifies one of the bar code lengths for "Datalogic 2 of 5 Length Control" on page 155. Length 1 is the minimum label length if in Variable Length Mode, or the first fixed length if in Fixed Length Mode. The length includes the bar code's check and data characters. The length can be set from 2 to 50 characters in increments of two. See "Set Length 1" on page 249 for more detailed programming instructions.



Select Datalogic 2 of 5 Length 1 Setting

To configure this feature, scan the ENTER/EXIT PROGRAMMING MODE bar code above, then the bar code at left followed by the digits from the Alphanumeric characters in Appendix D, Keypad representing your desired character(s). End by scanning the ENTER/EXIT bar code again.

Make a mistake? Scan the CANCEL bar code to abort and not save the entry string. You can then start again at the beginning.



CANCEL

★ Length 1 = 06 (6 characters)

## Datalogic 2 of 5 Set Length 2

This feature specifies one of the bar code lengths for "Datalogic 2 of 5 Length Control" on page 155. Length 2 is the maximum label length if in Variable Length Mode, or the second fixed length if in Fixed Length Mode. The length includes the bar code's check and data characters. The length can be set from 2 to 50 characters. A setting of 00 specifies to ignore this length (only one fixed length). See "Set Length 2" on page 250 for more detailed programming instructions.



Select Datalogic 2 of 5 Set Length 2 Setting

To configure this feature, scan the ENTER/EXIT PROGRAMMING MODE bar code above, then the bar code at left followed by the digits from the Alphanumeric characters in Appendix D, Keypad representing your desired character(s). End by scanning the ENTER/EXIT bar code again.

Make a mistake? Scan the CANCEL bar code to abort and not save the entry string. You can then start again at the beginning.



CANCEL

★ Length 2 = 50 (50 characters)





## INDUSTRIAL 2 OF 5

The following options apply to the Industrial 2 of 5 symbology.

### Industrial 2 of 5 Enable/Disable

When disabled, the reader will not read Industrial 2 of 5 bar codes.



★ Industrial 2 of 5 = Disable



Industrial 2 of 5 = Enable

### Industrial 2 of 5 Check Character Calculation

Enables/Disables calculation and verification of an optional Industrial 2 of 5 check character.



★ Industrial 2 of 5 Check Character Calculation  
= Disable



Industrial 2 of 5 Check Character Calculation = Enable



## Industrial 2 of 5 Check Character Transmission

Enables/disables transmission of an Industrial 2 of 5 check character.



Industrial 2 of 5 Check Character Transmission  
= Don't Send



★ Industrial 2 of 5 Check Character Transmission  
= Send

## Industrial 2 of 5 Length Control

This feature specifies either variable length decoding or fixed length decoding for the Industrial 2 of 5 symbology.

**Variable Length:** For variable-length decoding, a minimum length may be set.

**Fixed Length:** For fixed-length decoding, two different lengths may be set.



★ Industrial 2 of 5 Length Control = Variable Length



Industrial 2 of 5 Length Control = Fixed Length



## Industrial 2 of 5 Set Length 1

This feature specifies one of the bar code lengths for "Industrial 2 of 5 Length Control" on [page 158](#). Length 1 is the minimum label length if in Variable Length Mode, or the first fixed length if in Fixed Length Mode. The length includes the bar code's check and data characters.

The length can be set from 1 to 50 characters. See "Set Length 1" on [page 249](#) for more detailed programming instructions.



Select Industrial 2 of 5 Length 1 Setting

To configure this feature, scan the ENTER/EXIT PROGRAMMING MODE bar code above, then the bar code at left followed by the digits from the Alphanumeric characters in [Appendix D, Keypad](#) representing your desired character(s). End by scanning the ENTER/EXIT bar code again.

Make a mistake? Scan the CANCEL bar code to abort and not save the entry string. You can then start again at the beginning.



CANCEL

★ Length 1 = 06 (6 characters)

## Industrial 2 of 5 Set Length 2

This feature specifies one of the bar code lengths for "Industrial 2 of 5 Length Control" on [page 158](#). Length 2 is the maximum label length if in Variable Length Mode, or the second fixed length if in Fixed Length Mode. The length includes the bar code's check and data characters.

The length can be set from 1 to 50 characters. A setting of 00 specifies to ignore this length (only one fixed length). See "Set Length 2" on [page 250](#) for more detailed programming instructions.



Select Industrial 2 of 5 Set Length 2 Setting

To configure this feature, scan the ENTER/EXIT PROGRAMMING MODE bar code above, then the bar code at left followed by the digits from the Alphanumeric characters in [Appendix D, Keypad](#) representing your desired character(s). End by scanning the ENTER/EXIT bar code again.

Make a mistake? Scan the CANCEL bar code to abort and not save the entry string. You can then start again at the beginning.



CANCEL

★ Length 2 = 50 (50 characters)



# IATA

The following options apply to the IATA symbology.

## IATA Enable/Disable

Enables/Disables the ability of the reader to decode IATA labels.



★ IATA = Disable



IATA = Enable

## IATA Check Character Transmission

Enables/Disables calculation and verification of an optional IATA check character.



IATA Check Character Transmission  
= Don't Send



★ IATA Check Character Transmission  
= Send



## FOLLETT 2 OF 5

The following options apply to the Follett 2 of 5 symbology.

### Follett 2 of 5 Enable/Disable

Enables/Disables ability of reader to decode Follett 2 of 5 labels.



★ Follett 2 of 5 = Disable



Follett 2 of 5 = Enable



# CODABAR

The following options apply to the Codabar symbology.

## Codabar Enable/Disable

When disabled, the reader will not read Codabar bar codes.



★ Codabar = Disable



Codabar = Enable

## Codabar Check Character Calculation

This option enables/disables calculation and verification of an optional Codabar check character. When disabled, any check characters in the label are treated as data characters.



★ Codabar Check Character Calculation = Disable



Codabar Check Character Calculation  
= Calculate AIM Std Check



Codabar Check Character Calculation  
= Calculate Modulo 10 Check



Codabar Check Character Calculation  
= Calculate NW-7 Check



## Codabar Check Character Transmission

Enable this option to transmit the check character along with Codabar bar code data.



**NOTE: This feature is valid only when Codabar Check Character Calculation is enabled.**



Codabar Check Character Transmission  
= Don't Send



★ Codabar Check Character Transmission  
= Send

## Codabar Start/Stop Character Transmission

This option enables/disables transmission of Codabar start and stop characters.



Codabar Start/Stop Character Transmission  
= Don't Transmit



★ Codabar Start/Stop Character Transmission  
= Transmit



## Codabar Start/Stop Character Set

This option specifies the format of transmitted Codabar start/stop characters.



Codabar Check Character Set = ABCD/TN\*E



Codabar Check Character Set = ABCD/ABCD



Codabar Check Character Set = abcd/tn\*e



★ Codabar Check Character Set = abcd/abcd

## Codabar Start/Stop Character Match

When enabled, this option requires that start and stop characters match



★ Codabar Start/Stop Character Match  
= Don't Require Match



Codabar Start/Stop Character Match = Require Match





## Codabar Quiet Zones

This feature specifies the number of quiet zones for Codabar labels. Quiet zones are blank areas at the ends of a bar code and are typically 10 times the width of the narrowest bar or space in the label.



Codabar Quiet Zones = Quiet Zone on one side



★ Codabar Quiet Zones = Quiet Zones on two sides



Codabar Quiet Zones = Auto



Codabar Quiet Zones = Virtual Quiet Zones on two sides



Codabar Quiet Zones = Small Quiet Zones on two sides



## Codabar Length Control

This feature specifies either variable length decoding or fixed length decoding for the Codabar symbology.

**Variable Length:** For variable-length decoding, a minimum length may be set.

**Fixed Length:** For fixed-length decoding, two different lengths may be set.



★ Codabar Length Control = Variable Length



Codabar Length Control = Fixed Length

## Codabar Set Length 1

This feature specifies one of the bar code lengths for "Codabar Length Control" on page 166. Length 1 is the minimum label length if in Variable Length Mode, or the first fixed length if in Fixed Length Mode. Length includes the bar code's start, stop, check and data characters. The length must include at least one data character.

The length can be set from 3 to 50 characters. See "Set Length 1" on page 249 for more detailed programming instructions.



Select Codabar Length 1 Setting

To configure this feature, scan the ENTER/EXIT PROGRAMMING MODE bar code above, then the bar code at left followed by the digits from the Alphanumeric characters in Appendix D, Keypad representing your desired character(s). End by scanning the ENTER/EXIT bar code again.

Make a mistake? Scan the CANCEL bar code to abort and not save the entry string. You can then start again at the beginning.



CANCEL

★ Length 1 = 03 (3 characters)



## Codabar Set Length 2

This feature specifies one of the bar code lengths for "Codabar Length Control" on page 166. Length 2 is the maximum label length if in Variable Length Mode, or the second fixed length if in Fixed Length Mode. The length includes the bar code's start, stop, check and data characters. The length must include at least one data character.

The length can be set from 3 to 50 characters. A setting of 00 specifies to ignore this length (only one fixed length). See "Set Length 2" on page 250 for more detailed programming instructions.



Select Codabar Length 2 Setting

To configure this feature, scan the ENTER/EXIT PROGRAMMING MODE bar code above, then the bar code at left followed by the digits from the Alphanumeric characters in [Appendix D, Keypad](#) representing your desired character(s). End by scanning the ENTER/EXIT bar code again.

Make a mistake? Scan the CANCEL bar code to abort and not save the entry string. You can then start again at the beginning.



CANCEL

★ Length 2 = 50 (50 characters)



## ABC CODABAR

The following options apply to the ABC Codabar symbology.

### ABC Codabar Enable/Disable

Enables/Disables ability of reader to decode ABC Codabar labels.



★ ABC Codabar = Disable



ABC Codabar = Enable

### ABC Codabar Concatenation Mode

Specifies the concatenation mode between Static and Dynamic.



★ ABC Codabar Concatenation Mode = Static



ABC Codabar Concatenation Mode = Dynamic



## ABC Codabar Dynamic Concatenation Timeout

This parameter specifies the timeout in 10-millisecond ticks used by the ABC Codabar Dynamic Concatenation Mode. The timeout can be set within a range of 05 to 255 in 10ms increments. A setting of zero specifies no delay.



Select ABC Codabar Dynamic Concatenation  
Timeout Setting

To configure this feature, scan the ENTER/EXIT PROGRAMMING MODE bar code above, then the bar code at left followed by the digits from the Alphanumeric characters in [Appendix D, Keypad](#) representing your desired character(s). End by scanning the ENTER/EXIT bar code again.

Make a mistake? Scan the CANCEL bar code to abort and not save the entry string. You can then start again at the beginning.



CANCEL

★ Timeout = 20 (200 msec)

## ABC Codabar Force Concatenation

When ABC Codabar Concatenation is enabled and Force Concatenation is disabled, both Codabar stand alone labels and ABC Codabar concatenated labels are transmitted. When ABC Codabar Concatenation is enabled and Force Concatenation is enabled only ABC Codabar concatenated labels are transmitted while Codabar stand alone labels are not transmitted.

Force Concatenation has no effect if the ABC Codabar Concatenation is disabled. The Force Concatenation mode has effect both in Static and Dynamic Concatenation Modes.



★ ABC Codabar Force Concatenation = Disable



ABC Codabar Force Concatenation = Enable



## ISBT 128

The following options apply to the ISBT 128 symbology.

### ISBT 128 Concatenation

Enables/disables ISBT 128 concatenation of 2 labels.



★ ISBT 128 Concatenation = Disable



ISBT 128 Concatenation = Enable

### ISBT 128 Concatenation Mode

Specifies the concatenation mode between Static and Dynamic.



★ ISBT 128 Concatenation Mode = Static



ISBT 128 Concatenation Mode = Dynamic



## ISBT 128 Dynamic Concatenation Timeout

Specifies the timeout used by the ISBT 128 Dynamic Concatenation Mode.



ISBT 128 Dynamic Concatenation Timeout = 50 msec



ISBT 128 Dynamic Concatenation Timeout = 100 msec



★ ISBT 128 Dynamic Concatenation Timeout = 200 msec



ISBT 128 Dynamic Concatenation Timeout = 500 msec



ISBT 128 Dynamic Concatenation Timeout = 750 msec



ISBT 128 Dynamic Concatenation Timeout = 1 second



## ISBT 128 Force Concatenation

When enabled, this feature forces all ISBT 128 labels to be concatenated.



**NOTE: This option is only valid when "ISBT 128 Concatenation" on page 170 is enabled.**



★ ISBT 128 Force Concatenation = Disable



ISBT 128 Force Concatenation = Enable

## ISBT 128 Advanced Concatenation Options



**NOTE: Use the Datalogic Aladdin configuration application or Contact Customer Support to set up pairs of label types for concatenation.**





## CODE 11

The following options apply to the Code 11 symbology.

### Code 11 Enable/Disable

When disabled, the reader will not read Code 11 bar codes.



★ Code 11 = Disable



Code 11 = Enable

### Code 11 Check Character Calculation

This option enables/disables calculation and verification of optional Code 11 check character.



Code 11 Check Character Calculation = Disable



Code 11 Check Character Calculation = Calculate Check C



Code 11 Check Character Calculation  
= Calculate Check K



★ Code 11 Check Character Calculation  
= Calculate Check C and K



## Code 11 Check Character Transmission

This feature enables/disables transmission of an optional Code 11 check character.



Code 11 Check Character Transmission = Don't Send



★ Code 11 Check Character Transmission = Send

## Code 11 Length Control

This feature specifies either variable length decoding or fixed length decoding for the Code 11 symbology.

**Variable Length:** For variable-length decoding, a minimum length may be set.

**Fixed Length:** For fixed-length decoding, two different lengths may be set.



★ Code 11 Length Control = Variable Length



Code 11 Length Control = Fixed Length



## Code 11 Set Length 1

This feature specifies one of the bar code lengths for "Code 11 Length Control" on page 174. Length 1 is the minimum label length if in Variable Length Mode, or the first fixed length if in Fixed Length Mode. Length includes the bar code's check and data characters.

The length can be set from 2 to 50 characters. See "Set Length 1" on page 249 for more detailed programming instructions.



Select Code 11 Length 1 Setting

To configure this feature, scan the ENTER/EXIT PROGRAMMING MODE bar code above, then the bar code at left followed by the digits from the Alphanumeric characters in [Appendix D, Keypad](#) representing your desired character(s). End by scanning the ENTER/EXIT bar code again.

Make a mistake? Scan the CANCEL bar code to abort and not save the entry string. You can then start again at the beginning.



CANCEL

★ Length 1 = 04 (4 characters)

## Code 11 Set Length 2

This feature specifies one of the bar code lengths for "Code 11 Length Control" on page 174. Length 2 is the maximum label length if in Variable Length Mode, or the second fixed length if in Fixed Length Mode. Length includes the bar code's check and data characters.

The length can be set from 2 to 50 characters. A setting of 00 specifies to ignore this length (only one fixed length). See "Set Length 2" on page 250 for more detailed programming instructions.



Select Code 11 Length 2 Setting

To configure this feature, scan the ENTER/EXIT PROGRAMMING MODE bar code above, then the bar code at left followed by the digits from the Alphanumeric characters in [Appendix D, Keypad](#) representing your desired character(s). End by scanning the ENTER/EXIT bar code again.

Make a mistake? Scan the CANCEL bar code to abort and not save the entry string. You can then start again at the beginning.



CANCEL

★ Length 2 = 50 (50 characters)



## CODE 93

The following options apply to the Code 93 symbology.

### Code 93 Enable/Disable

Enables/Disables ability of reader to decode Code 93 labels.



★ Code 93 = Disable



Code 93 = Enable

### Code 93 Check Character Calculation

This option enables/disables calculation and verification of optional Code 93 check character.



Code 93 Check Character Calculation = Disable



Code 93 Check Character Calculation = Calculate Check C



Code 93 Check Character Calculation  
= Calculate Check K



★ Code 93 Check Character Calculation  
= Calculate Check C and K



## Code 93 Check Character Transmission

This feature enables/disables transmission of an optional Code 93 check character.



★ Code 93 Check Character Transmission = Don't Send



Code 93 Check Character Transmission = Send

## Code 93 Length Control

This feature specifies either variable length decoding or fixed length decoding for the Code 93 symbology.

**Variable Length:** For variable-length decoding, a minimum length may be set.

**Fixed Length:** For fixed-length decoding, two different lengths may be set.



★ Code 93 Length Control = Variable Length



Code 93 Length Control = Fixed Length



### Code 93 Set Length 1

This feature specifies one of the bar code lengths for "Code 93 Length Control" on page 177. Length 1 is the minimum label length if in Variable Length Mode, or the first fixed length if in Fixed Length Mode. Length includes the bar code's check and data characters.

The length can be set from 1 to 50 characters. See "Set Length 1" on page 249 for more detailed programming instructions.



Select Code 93 Length 1 Setting

To configure this feature, scan the ENTER/EXIT PROGRAMMING MODE bar code above, then the bar code at left followed by the digits from the Alphanumeric characters in Appendix D, Keypad representing your desired character(s). End by scanning the ENTER/EXIT bar code again.

Make a mistake? Scan the CANCEL bar code to abort and not save the entry string. You can then start again at the beginning.



CANCEL

★ Length 1 = 01 (one character)

### Code 93 Set Length 2

This feature specifies one of the bar code lengths for "Code 93 Length Control" on page 177. Length 2 is the maximum label length if in Variable Length Mode, or the second fixed length if in Fixed Length Mode. The length includes the bar code's check and data characters.

The length can be set from 1 to 50 characters. A setting of 00 specifies to ignore this length (only one fixed length). See "Set Length 2" on page 250 for more detailed programming instructions.



Select Code 93 Length 2 Setting

To configure this feature, scan the ENTER/EXIT PROGRAMMING MODE bar code above, then the bar code at left followed by the digits from the Alphanumeric characters in Appendix D, Keypad representing your desired character(s). End by scanning the ENTER/EXIT bar code again.

Make a mistake? Scan the CANCEL bar code to abort and not save the entry string. You can then start again at the beginning.



CANCEL

★ Length 2 = 50 (50 characters)



## Code 93 Quiet Zones

This feature specifies the number of quiet zones for Code 93 labels. Quiet zones are blank areas at the ends of a bar code and are typically 10 times the width of the narrowest bar or space in the label.



Code 93 Quiet Zones = No Quiet Zones



Code 93 Quiet Zones = Quiet Zone on one side



Code 93 Quiet Zones = Quiet Zones on two sides



★ Code 93 Quiet Zones = Auto



Code 93 Quiet Zones = Virtual Quiet Zones on two sides



# MSI

The following options apply to the MSI symbology.

## MSI Enable/Disable

Enables/Disables ability of reader to decode MSI labels.



★ MSI = Disable



MSI = Enable

## MSI Check Character Calculation

Enables/Disables calculation and verification of an optional MSI check character.



MSI Check Character Calculation = Disable



★ MSI Check Character Calculation = Calculate Mod 10



MSI Check Character Calculation  
= Calculate Mod 11/10



MSI Check Character Calculation  
= Calculate Mod 10/10





## MSI Check Character Transmission

Enables/disables transmission of an MSI check character.



MSI Check Character Transmission = Don't Send



★ MSI Check Character Transmission = Send

## MSI Length Control

This feature specifies either variable length decoding or fixed length decoding for the MSI symbology.

**Variable Length:** For variable-length decoding, a minimum length may be set.

**Fixed Length:** For fixed-length decoding, two different lengths may be set.



★ MSI Length Control = Variable Length



MSI Length Control = Fixed Length



## MSI Set Length 1

This feature specifies one of the bar code lengths for "MSI Length Control" on page 181. Length 1 is the minimum label length if in Variable Length Mode, or the first fixed length if in Fixed Length Mode. Length includes the bar code's data characters only.

The length can be set from 1 to 50 characters. See "Set Length 1" on page 249 for more detailed programming instructions.



Select MSI Length 1 Setting

To configure this feature, scan the ENTER/EXIT PROGRAMMING MODE bar code above, then the bar code at left followed by the digits from the Alphanumeric characters in [Appendix D, Keypad](#) representing your desired character(s). End by scanning the ENTER/EXIT bar code again.

Make a mistake? Scan the CANCEL bar code to abort and not save the entry string. You can then start again at the beginning.



CANCEL

★ Length 1 = 01 (one character)

## MSI Set Length 2

This feature specifies one of the bar code lengths for "MSI Length Control" on page 181. Length 2 is the maximum label length if in Variable Length Mode, or the second fixed length if in Fixed Length Mode. The length includes the bar code's data characters only.

The length can be set from 1 to 50 characters. A setting of 00 specifies to ignore this length (only one fixed length). See "Set Length 2" on page 250 for more detailed programming instructions.



Select MSI Length 2 Setting

To configure this feature, scan the ENTER/EXIT PROGRAMMING MODE bar code above, then the bar code at left followed by the digits from the Alphanumeric characters in [Appendix D, Keypad](#) representing your desired character(s). End by scanning the ENTER/EXIT bar code again.

Make a mistake? Scan the CANCEL bar code to abort and not save the entry string. You can then start again at the beginning.



CANCEL

★ Length 2 = 50 (50 characters)



# PLESSEY

The following options apply to the Plessey symbology.

## Plessey Enable/Disable

Enables/Disables ability of reader to decode Plessey labels.



★ Plessey = Disable



Plessey = Enable

## Plessey Check Character Calculation

Enables/Disables calculation and verification of a Plessey check character.



Plessey Check Character Calculation = Disable



★ Plessey Check Character Calculation  
= Plessey std check char. verification



Plessey Check Character Calculation  
= Anker check char. verification



Plessey Check Character Calculation  
= Plessey std and Anker check char. verification



## Plessey Check Character Transmission

Enables/disables transmission of a Plessey check character.



Plessey Check Character Transmission = Don't Send



★ Plessey Check Character Transmission = Send

## Plessey Length Control

This feature specifies either variable length decoding or fixed length decoding for the Plessey symbology.

**Variable Length:** For variable-length decoding, a minimum length may be set.

**Fixed Length:** For fixed-length decoding, two different lengths may be set.



★ Plessey Length Control = Variable Length



Plessey Length Control = Fixed Length



## Plessey Set Length 1

This feature specifies one of the bar code lengths for "Plessey Length Control" on page 184. Length 1 is the minimum label length if in Variable Length Mode, or the first fixed length if in Fixed Length Mode. The length includes the bar code's check and data characters.

The length can be set from 1 to 50 characters. See "Set Length 1" on page 249 for more detailed programming instructions.



Select Plessey Length 1 Setting

To configure this feature, scan the ENTER/EXIT PROGRAMMING MODE bar code above, then the bar code at left followed by the digits from the Alphanumeric characters in [Appendix D, Keypad](#) representing your desired character(s). End by scanning the ENTER/EXIT bar code again.

Make a mistake? Scan the CANCEL bar code to abort and not save the entry string. You can then start again at the beginning.



CANCEL

★ Length 1 = 01 (one character)

## Plessey Set Length 2

This feature specifies one of the bar code lengths for "Plessey Length Control" on page 184. Length 2 is the maximum label length if in Variable Length Mode, or the second fixed length if in Fixed Length Mode. The length includes the bar code's check and data characters.

Length can be set from 1 to 50 characters. A setting of 00 specifies to ignore this length (only one fixed length). See "Set Length 2" on page 250 for more detailed programming instructions.



Select Plessey Length 2 Setting

To configure this feature, scan the ENTER/EXIT PROGRAMMING MODE bar code above, then the bar code at left followed by the digits from the Alphanumeric characters in [Appendix D, Keypad](#) representing your desired character(s). End by scanning the ENTER/EXIT bar code again.

Make a mistake? Scan the CANCEL bar code to abort and not save the entry string. You can then start again at the beginning.



CANCEL

★ Length 2 = 50 (50 characters)



## BC412

The following options apply to the BC412 symbology.

### BC412 Enable/Disable

Enables/Disables ability of reader to decode BC412 labels.



★ BC412 = Disable



BC412 = Enable

### BC412 Check Character Calculation

Enable this option to enable/disable calculation and verification of an optional BC412 check character. When disabled, any check character in the label is treated as a data character.



BC412 Check Character Calculation = Disable



★ BC412 Check Character Calculation = Calculate



## BC412 Length Control

This feature specifies either variable length decoding or fixed length decoding for the BC412 symbology.

**Variable Length:** For variable-length decoding, a minimum length may be set.

**Fixed Length:** For fixed-length decoding, two different lengths may be set.



★ BC412 Length Control = Variable Length



BC412 Length Control = Fixed Length



## BC412 Set Length 1

This feature specifies one of the bar code lengths for "BC412 Length Control" on page 187. Length 1 is the minimum label length if in Variable Length Mode, or the first fixed length if in Fixed Length Mode. Length includes the bar code's data characters only.

The length can be set from 01 to 50 characters. See "Set Length 1" on page 249 for more detailed programming instructions.



Select BC412 Length 1 Setting

To configure this feature, scan the ENTER/EXIT PROGRAMMING MODE bar code above, then the bar code at left followed by the digits from the Alphanumeric characters in [Appendix D, Keypad](#) representing your desired character(s). End by scanning the ENTER/EXIT bar code again.

Make a mistake? Scan the CANCEL bar code to abort and not save the entry string. You can then start again at the beginning.



CANCEL

★ Length 1 = 01 (one character)

## BC412 Set Length 2

This feature specifies one of the bar code lengths for "BC412 Length Control" on page 187. Length 2 is the maximum label length if in Variable Length Mode, or the second fixed length if in Fixed Length Mode. Length includes the bar code's data characters only.

The length can be set from 01 to 50 characters. A setting of 00 specifies to ignore this length (only one fixed length). See "Set Length 2" on page 250 for more detailed programming instructions.



Select BC412 Length 2 Setting

To configure this feature, scan the ENTER/EXIT PROGRAMMING MODE bar code above, then the bar code at left followed by the digits from the Alphanumeric characters in [Appendix D, Keypad](#) representing your desired character(s). End by scanning the ENTER/EXIT bar code again.

Make a mistake? Scan the CANCEL bar code to abort and not save the entry string. You can then start again at the beginning.



CANCEL

★ Length 2 = 50 (50 characters)



# CONFIGURATION | 2D SYMBOLOGIES

## SECTION CONTENTS

- **2D GLOBAL FEATURES** starting on page 190
- **AZTEC CODE** starting on page 193
- **CHINA SENSIBLE CODE** starting on page 195
- **DATA MATRIX** starting on page 197
- **GS1 DotCODE** starting on page 200
- **MAXICODE** starting on page 202
- **PDF417** starting on page 205
- **MICRO PDF417** starting on page 207
- **QR CODE** starting on page 210
- **MICRO QR CODE** starting on page 212
- **UCC COMPOSITE** starting on page 214

The reader supports the following 2D symbologies (bar code types). Symbology-dependent options for each symbology are included in this chapter. See "**1D SYMBOLOGIES** starting on page 103 for configuration of 1D bar codes.

---

## 2D GLOBAL FEATURES

The following features are common to all, or in some cases, most of the available 2D symbologies. Default settings are indicated at each feature/option with a green arrow. Also reference Appendix B, Standard Defaults for a listing of the most widely used set of standard factory settings. That section also provides space to record any custom settings needed or implemented for your system.

To set most features:

1. Scan the ENTER/EXIT PROGRAMMING bar code at the top of applicable programming pages.
2. Scan the correct bar code to set the desired programming feature or parameter. You may need to cover unused bar codes on the page, and possibly the facing page, to ensure that the reader reads only the bar code you intend to scan.
3. If additional input parameters are needed, go to Appendix D, Keypad, and scan the appropriate characters from the keypad.



**NOTE: Additional information about many features can be found in the “References” chapter.**

**If you make a mistake before the last character, scan the CANCEL bar code to abort and not save the entry string. You can then start again at the beginning.**

Complete the programming sequence by scanning the ENTER/EXIT PROGRAMMING bar code to exit Programming Mode.



## 2D Maximum Decoding Time

This feature specifies the maximum amount of time the software will spend attempting to decode a 2D label. The selectable range is 10 milliseconds to 2.55 milliseconds.



2D Maximum Decoding Time = 100 msec



2D Maximum Decoding Time = 200 msec



★ 2D Maximum Decoding Time = 350 msec



2D Maximum Decoding Time = 500 msec



2D Maximum Decoding Time = 1 Second



2D Maximum Decoding Time = 2 Seconds



2D Maximum Decoding Time = 2.55 Seconds



## 2D Structured Append

Enables/disables ability of reader to append multiple 2D Codes labels in a structured format. The structured append property is globally applied to the following symbologies, if these are enabled:

- Data Matrix
- Aztec
- QR Code
- PDF 417



★ Structured Append = Disable



Structured Append = Enable

## 2D Normal/Inverse Symbol Control

Specifies the options available for decoding normal/negative printed 2D symbols. This configuration item applies globally to all the 2D symbologies that support that feature according to Standard AIM Specification: Data Matrix, QR, MicroQR, Aztec and Chinese Sensible Code.



★ Normal/Inverse Symbol Control = Normal



Normal/Inverse Symbol Control = Inverse



Normal/Inverse Symbol Control = Both Normal and Inverse



## AZTEC CODE

### Aztec Code Enable / Disable

Enables/disables the ability of the reader to decode Aztec Code labels.



Aztec Code = Disable



★ Aztec Code = Enable

### Aztec Code Length Control

This feature specifies either variable length decoding or fixed length decoding for this symbology.

**Variable Length:** For variable length decoding, a minimum and maximum length may be set.

**Fixed Length:** For fixed length decoding, two different lengths may be set.



★ Aztec Code Length Control = Variable Length



Aztec Code Length Control = Fixed Length



## Aztec Code Set Length 1

Specifies one of the bar code lengths for "Aztec Code Length Control" on page 193.

Length 1 is the minimum label length if in Variable Length Mode, or the first fixed length if in Fixed Length Mode. Characters can be set from 0001 to 3,832 characters in increments of 0001 (pad with zeroes).

See "Set Length 1" on page 249 for detailed instructions on setting this feature.



Select Aztec Code Length 1 Setting

To configure this feature, scan the ENTER/EXIT PROGRAMMING MODE bar code above, then the bar code at left followed by the digits from the Alphanumeric characters in [Appendix D, Keypad](#) representing your desired character(s). End by scanning the ENTER/EXIT bar code again.

Make a mistake? Scan the CANCEL bar code to abort and not save the entry string. You can then start again at the beginning.



CANCEL

★ 0001 = Length 1 is 1 Character

## Aztec Code Set Length 2

Specifies one of the bar code lengths for "Aztec Code Length Control" on page 193.

Length 2 is the minimum label length if in Variable Length Mode, or the first fixed length if in Fixed Length Mode. Characters can be set from 0001 to 3,832 characters in increments of 0001 (pad with zeroes).

See "Set Length 2" on page 250 for detailed instructions on setting this feature.



Select Aztec Code Length 2 Setting

To configure this feature, scan the ENTER/EXIT PROGRAMMING MODE bar code above, then the bar code at left followed by the digits from the Alphanumeric characters in [Appendix D, Keypad](#) representing your desired character(s). End by scanning the ENTER/EXIT bar code again.

Make a mistake? Scan the CANCEL bar code to abort and not save the entry string. You can then start again at the beginning.



CANCEL

★ Length 2 is 3,832 Characters



## CHINA SENSIBLE CODE

### China Sensible Code Enable / Disable

Enables/disables the ability of the reader to decode China Sensible Code labels.



★ China Sensible Code = Disable



China Sensible Code = Enable

### China Sensible Code Length Control

This feature specifies either variable length decoding or fixed length decoding for this symbology.

**Variable Length:** For variable length decoding, a minimum and maximum length may be set.

**Fixed Length:** For fixed length decoding, two different lengths may be set.



★ China Sensible Code Length Control = Variable Length



China Sensible Code Length Control = Fixed Length



## China Sensible Code Set Length 1

Specifies one of the bar code lengths for "China Sensible Code Length Control" on page 195. Length 1 is the minimum label length if in Variable Length Mode, or the first fixed length if in Fixed Length Mode. Characters can be set from 0001 to 7,827 characters in increments of 0001 (pad with zeroes).

See "Set Length 1" on page 249 for detailed instructions on setting this feature.



Select China Sensible Code Length 1 Setting

To configure this feature, scan the ENTER/EXIT PROGRAMMING MODE bar code above, then the bar code at left followed by the digits from the Alphanumeric characters in Appendix D, Keypad representing your desired character(s). End by scanning the ENTER/EXIT bar code again.

Make a mistake? Scan the CANCEL bar code to abort and not save the entry string. You can then start again at the beginning.



CANCEL

★ 0001 = Length 1 is 1 Character

## China Sensible Code Set Length 2

This feature specifies one of the bar code lengths for "China Sensible Code Length Control" on page 195. Length 2 is the maximum label length if in Variable Length Mode, or the second fixed length if in Fixed Length Mode. Characters can be set from 0001 to 7,827 characters in increments of 0001 (pad with zeroes).

See "Set Length 2" on page 250 for detailed instructions on setting this feature.



Select China Sensible Code Length 2 Setting

To configure this feature, scan the ENTER/EXIT PROGRAMMING MODE bar code above, then the bar code at left followed by the digits from the Alphanumeric characters in Appendix D, Keypad representing your desired character(s). End by scanning the ENTER/EXIT bar code again.

Make a mistake? Scan the CANCEL bar code to abort and not save the entry string. You can then start again at the beginning.



CANCEL

★ Length 2 is 7,827 Characters





## DATA MATRIX

### Data Matrix Enable / Disable

Enables/disables ability of reader to decode Data Matrix labels.



Data Matrix = Disable



★ Data Matrix = Enable

### Data Matrix Square/Rectangular Style

Specifies the options available when reading Data Matrix with different form factors. Choices are:

- Square Style
- Rectangular Style
- Both Square and Rectangular Style

The configuration item can also be configured as a bit mask to filter one or more Data Matrix labels with different symbol size AND shape styles.



Data Matrix Dimensions Mask = Square Style



Data Matrix Dimensions Mask = Rectangular Style



★ Data Matrix Dimensions Mask = Both Square and Rectangular Style



## Data Matrix Length Control

This feature specifies either variable length decoding or fixed length decoding for this symbology.

**Variable Length:** For variable length decoding, a minimum and maximum length may be set.

**Fixed Length:** For fixed length decoding, two different lengths may be set.



★ Data Matrix Length Control = Variable Length



Data Matrix Length Control = Fixed Length

## Data Matrix Set Length 1

This feature specifies one of the bar code lengths for "Data Matrix Length Control" on page 198. Length 1 is the minimum label length if in Variable Length Mode, or the first fixed length if in Fixed Length Mode. Characters can be set from 0001 to 3,116 characters in increments of 0001 (pad with zeroes).

See "Set Length 1" on page 249 for detailed instructions on setting this feature.



Select Data Matrix Length 1 Setting

To configure this feature, scan the ENTER/EXIT PROGRAMMING MODE bar code above, then the bar code at left followed by the digits from the Alphanumeric characters in Appendix D, Keypad representing your desired character(s). End by scanning the ENTER/EXIT bar code again.

Make a mistake? Scan the CANCEL bar code to abort and not save the entry string. You can then start again at the beginning.



CANCEL

★ 0001 = Length 1 is 1 Character



## Data Matrix Set Length 2

This feature specifies one of the bar code lengths for "Data Matrix Length Control" on [page 198](#). Length 2 is the maximum label length if in Variable Length Mode, or the second fixed length if in Fixed Length Mode. Characters can be set from 0001 to 3,116 characters in increments of 0001 (pad with zeroes).

See "[Set Length 2](#)" on [page 250](#) for detailed instructions on setting this feature.



Select Data Matrix Length 2 Setting

To configure this feature, scan the ENTER/EXIT PROGRAMMING MODE bar code above, then the bar code at left followed by the digits from the Alphanumeric characters in [Appendix D, Keypad](#) representing your desired character(s). End by scanning the ENTER/EXIT bar code again.

Make a mistake? Scan the CANCEL bar code to abort and not save the entry string. You can then start again at the beginning.



CANCEL

★ Length 2 is 3,116 Characters



## GS1 DOTCODE

The following options apply for the DotCode barcode decoding

### DotCode Enable

This options enables/disables the ability of the reader to decode DotCode barcodes.



DotCode = Enable



★ DotCode = Disable

### DotCode High Resolution Enable

This options improves the decoding performance for very small module size barcodes, e.g. tobacco products.



★ DotCode High Resolution = Enable



DotCode High Resolution = Disable



## DotCode Position-based Decoding

This option can improve the decoding performance when the next barcode to be decoded is approximately shown in the same position as the previous one.



DotCode Position-based Decoding = Enable



★ DotCode Position-based Decoding = Disable

## Additional Options

To improve performances the following additional settings are available using Aladdin configuration utility, downloadable from [www.datalogic.com](http://www.datalogic.com).

- Dot Size
- Fixed Length or Variable Length
- Min and Max barcode size



# MAXICODE

## Maxicode Enable / Disable

Enables/disables ability of reader to decode Maxicode labels.



★ Maxicode = Disable



Maxicode = Enable

## Maxicode Primary Message Transmission

Enables/disables the transmission of only the Primary Message when the Secondary Message is not readable.



★ Maxicode Primary Message Transmission = Disable



Maxicode Primary Message Transmission = Enable



## Maxicode Length Control

This feature specifies either variable length decoding or fixed length decoding for this symbology.

**Variable Length:** For variable length decoding, a minimum and maximum length may be set.

**Fixed Length:** For fixed length decoding, two different lengths may be set.



★ Maxicode Length Control = Variable Length



Maxicode Length Control = Fixed Length

## Maxicode Set Length 1

Specifies one of the bar code lengths for "Maxicode Length Control" on page 203. Length 1 is the minimum label length if in Variable Length Mode, or the first fixed length if in Fixed Length Mode. Characters can be set from 0001 to 0145 characters in increments of 0001 (pad with zeroes).

See "Set Length 1" on page 249 for detailed instructions on setting this feature.



Select Maxicode Length 1 Setting

To configure this feature, scan the ENTER/EXIT PROGRAMMING MODE bar code above, then the bar code at left followed by the digits from the Alphanumeric characters in [Appendix D, Keypad](#) representing your desired character(s). End by scanning the ENTER/EXIT bar code again.

Make a mistake? Scan the CANCEL bar code to abort and not save the entry string. You can then start again at the beginning.



CANCEL

★ 0001 = Length 1 is 1 Character



## Maxicode Set Length 2

This feature specifies one of the bar code lengths for "[Maxicode Length Control](#)" on [page 203](#). Length 2 is the maximum label length if in Variable Length Mode, or the second fixed length if in Fixed Length Mode. Characters can be set from 0001 to 0145 characters in increments of 0001 (pad with zeroes).

See "[Set Length 2](#)" on [page 250](#) for detailed instructions on setting this feature.



Select Maxicode Length 2 Setting

To configure this feature, scan the ENTER/EXIT PROGRAMMING MODE bar code above, then the bar code at left followed by the digits from the Alphanumeric characters in [Appendix D, Keypad](#) representing your desired character(s). End by scanning the ENTER/EXIT bar code again.

Make a mistake? Scan the CANCEL bar code to abort and not save the entry string. You can then start again at the beginning.



CANCEL

★ Length 2 is 0145 Characters





## PDF417

### PDF417 Enable / Disable

Enables/disables the ability of the reader to decode PDF417 labels.



PDF417 = Disable



★ PDF417 = Enable

### PDF417 Length Control

This feature specifies either variable length decoding or fixed length decoding for this symbology.

**Variable Length:** For variable length decoding, a minimum and maximum length may be set.

**Fixed Length:** For fixed length decoding, two different lengths may be set.



★ PDF417 Length Control = Variable Length



PDF417 Length Control = Fixed Length



## PDF417 Set Length 1

Specifies one of the bar code lengths for "PDF417 Length Control" on page 205. Length 1 is the minimum label length if in Variable Length Mode, or the first fixed length if in Fixed Length Mode. Length includes the bar code's data characters only. Characters can be set from 0001 to 2,710 characters (pad with zeroes) in increments of 01. Any value greater than 2,710 will be considered to be 2,710.

See "Set Length 1" on page 249 for detailed instructions on setting this feature.



Select PDF417 Length 1 Setting

To configure this feature, scan the ENTER/EXIT PROGRAMMING MODE bar code above, then the bar code at left followed by the digits from the Alphanumeric characters in Appendix D, Keypad representing your desired character(s). End by scanning the ENTER/EXIT bar code again.

Make a mistake? Scan the CANCEL bar code to abort and not save the entry string. You can then start again at the beginning.



CANCEL

★ 0001 = Length 1 is 1 Character

## PDF417 Set Length 2

This feature specifies one of the bar code lengths for "PDF417 Length Control" on page 205. Length 2 is the maximum label length if in Variable Length Mode, or the second fixed length if in Fixed Length Mode. Length includes the bar code's check, data, and full-ASCII shift characters. The length does not include start/stop characters. Characters can be set from 01 to 2,710 characters (pad with zeroes) in increments of 01. Any value greater than 2,710 will be considered to be 2,710.

See "Set Length 2" on page 250 for detailed instructions on setting this feature.



Select PDF417 Length 2 Setting

To configure this feature, scan the ENTER/EXIT PROGRAMMING MODE bar code above, then the bar code at left followed by the digits from the Alphanumeric characters in Appendix D, Keypad representing your desired character(s). End by scanning the ENTER/EXIT bar code again.

Make a mistake? Scan the CANCEL bar code to abort and not save the entry string. You can then start again at the beginning.



CANCEL

★ Length 2 is 2,710 Characters



## MICRO PDF417

### Micro PDF417 Enable / Disable

Enables/disables the ability of the reader to decode Micro PDF417 labels.



Micro PDF417 = Disable



★ Micro PDF417 = Enable

### Micro PDF417 Code 128 GS1-128 Emulation

Specifies which AIM ID to use for Micro PDF labels when doing Code 128 or GS1-128 emulation.

Emulation choices are:

- Micro PDF AIM ID and label type
- Code 128 / EAN128 AIM Id and label type.



★ Micro PDF417 Code 128 GS1-128 Emulation =  
Micro PDF AIM ID and label type



Micro PDF417 Code 128 GS1-128 Emulation =  
Code 128 / EAN128 AIM ID and label type



## Micro PDF417 Length Control

This feature specifies either variable length decoding or fixed length decoding for this symbology.

**Variable Length:** For variable length decoding, a minimum and maximum length may be set.

**Fixed Length:** For fixed length decoding, two different lengths may be set.



★ Micro PDF417 Length Control = Variable Length



Micro PDF417 Length Control = Fixed Length

## Micro PDF417 Set Length 1

Specifies one of the bar code lengths for "Micro PDF417 Length Control" on page 208. Length 1 is the minimum label length if in Variable Length Mode, or the first fixed length if in Fixed Length Mode. Length includes the bar code's data characters only. Characters can be set from 0001 to 0366 characters (pad with zeroes) in increments of 01. Any value greater than 0366 will be considered to be 0366.

See "Set Length 1" on page 249 for detailed instructions on setting this feature.



Select Micro PDF417 Length 1 Setting

To configure this feature, scan the ENTER/EXIT PROGRAMMING MODE bar code above, then the bar code at left followed by the digits from the Alphanumeric characters in [Appendix D, Keypad](#) representing your desired character(s). End by scanning the ENTER/EXIT bar code again.

Make a mistake? Scan the CANCEL bar code to abort and not save the entry string. You can then start again at the beginning.



CANCEL

★ 0001 = Length 1 is 1 Character



## Micro PDF417 Set Length 2

This feature specifies one of the bar code lengths for "[Micro PDF417 Length Control](#)" on [page 208](#). Length 2 is the maximum label length if in Variable Length Mode, or the second fixed length if in Fixed Length includes the bar code's data characters only. Characters can be set from 0001 to 0366 characters (pad with zeroes) in increments of 01. Any value greater than 0366 will be considered to be 0366.

See "[Set Length 2](#)" on [page 250](#) for detailed instructions on setting this feature.



Select Micro PDF417 Length 2 Setting

To configure this feature, scan the ENTER/EXIT PROGRAMMING MODE bar code above, then the bar code at left followed by the digits from the Alphanumeric characters in [Appendix D, Keypad](#) representing your desired character(s). End by scanning the ENTER/EXIT bar code again.

Make a mistake? Scan the CANCEL bar code to abort and not save the entry string. You can then start again at the beginning.



CANCEL

★ Length 2 is 0366 Characters



## QR CODE

### QR Code Enable / Disable

Enables/disables the ability of the reader to decode QR Code labels.



QR Code = Disable



★ QR Code = Enable

### QR Code Length Control

This feature specifies either variable length decoding or fixed length decoding for this symbology.

**Variable Length:** For variable length decoding, a minimum and maximum length may be set.

**Fixed Length:** For fixed length decoding, two different lengths may be set.



★ QR Code Length Control = Variable Length



QR Code Length Control = Fixed Length



## QR Code Set Length 1

This feature specifies one of the bar code lengths for "QR Code Length Control" on page 210. Length 1 is the minimum label length if in Variable Length Mode, or the first fixed length if in Fixed Length Mode. Characters can be set from 0001 to 7,089 characters in increments of 0001 (pad with zeroes).

See "Set Length 1" on page 249 for detailed instructions on setting this feature.



Select QR Code Length 1 Setting

To configure this feature, scan the ENTER/EXIT PROGRAMMING MODE bar code above, then the bar code at left followed by the digits from the Alphanumeric characters in [Appendix D, Keypad](#) representing your desired character(s). End by scanning the ENTER/EXIT bar code again.

Make a mistake? Scan the CANCEL bar code to abort and not save the entry string. You can then start again at the beginning.



CANCEL

★ 0001 = Length 1 is 1 Character

## QR Code Set Length 2

This feature specifies one of the bar code lengths for "QR Code Length Control" on page 210. Length 2 is the maximum label length if in Variable Length Mode, or the second fixed length if in Fixed Length Mode. Characters can be set from 0001 to 7,089 characters in increments of 0001 (pad with zeroes).

See "Set Length 2" on page 250 for detailed instructions on setting this feature.



Select QR Code Length 2 Setting

To configure this feature, scan the ENTER/EXIT PROGRAMMING MODE bar code above, then the bar code at left followed by the digits from the Alphanumeric characters in [Appendix D, Keypad](#) representing your desired character(s). End by scanning the ENTER/EXIT bar code again.

Make a mistake? Scan the CANCEL bar code to abort and not save the entry string. You can then start again at the beginning.



CANCEL

★ Length 2 is 7,089 Characters



## MICRO QR CODE

### Micro QR Code Enable / Disable

Enables/disables the ability of the reader to decode Micro QR Code labels.



Micro QR Code = Disable



★ Micro QR Code = Enable

### Micro QR Code Length Control

This feature specifies either variable length decoding or fixed length decoding for this symbology.

**Variable Length:** For variable length decoding, a minimum and maximum length may be set.

**Fixed Length:** For fixed length decoding, two different lengths may be set.



★ Micro QR Code Length Control = Variable Length



Micro QR Code Length Control = Fixed Length





## Micro QR Code Set Length 1

This feature specifies one of the bar code lengths for "Micro QR Code Length Control" on page 212. Length 1 is the minimum label length if in Variable Length Mode, or the first fixed length if in Fixed Length Mode. Characters can be set from 0001 to 0035 characters in increments of 0001 (pad with zeroes).

See "Set Length 1" on page 249 for detailed instructions on setting this feature.



Select Micro QR Code Length 1 Setting

To configure this feature, scan the ENTER/EXIT PROGRAMMING MODE bar code above, then the bar code at left followed by the digits from the Alphanumeric characters in Appendix D, Keypad representing your desired character(s). End by scanning the ENTER/EXIT bar code again.

Make a mistake? Scan the CANCEL bar code to abort and not save the entry string. You can then start again at the beginning.



CANCEL

★0001 = Length 1 is 1 Character

## Micro QR Code Set Length 2

This feature specifies one of the bar code lengths for "Micro QR Code Length Control" on page 212. Length 2 is the maximum label length if in Variable Length Mode, or the second fixed length if in Fixed Length Mode. Characters can be set from 0001 to 0035 characters in increments of 0001 (pad with zeroes).

See "Set Length 2" on page 250 for detailed instructions on setting this feature.



Select Micro QR Code Length 2 Setting

To configure this feature, scan the ENTER/EXIT PROGRAMMING MODE bar code above, then the bar code at left followed by the digits from the Alphanumeric characters in Appendix D, Keypad representing your desired character(s). End by scanning the ENTER/EXIT bar code again.

Make a mistake? Scan the CANCEL bar code to abort and not save the entry string. You can then start again at the beginning.



CANCEL

★Length 2 is 0035 Characters



# UCC COMPOSITE

## UCC Optional Composite Timer

Specifies the amount of time the system will wait for the stacked part of a UCC Composite label before transmitting the linear label without an add-on.



★ UCC Optional Composite Timer = Timer Disabled



UCC Optional Composite Timer = 70 msec



UCC Optional Composite Timer = 100 msec



UCC Optional Composite Timer = 200 msec



UCC Optional Composite Timer = 300 msec



## Postal Code Selection

Enables/disables the ability of the reader to decode labels of a specific postal symbol-ogy.

- Disable All Postal Codes
- Postnet
- Planet
- Royal Mail
- Kix
- Australia Post
- Japan Post
- IMB
- Sweden Post
- Portugal Post



★ Postal Code Selection = Disable All Postal Codes



Postal Code Selection = Enable Postnet



Postal Code Selection = Enable Planet



Postal Code Selection = Enable Royal Mail



Postal Code Selection = Enable Kix



Postal Code Selection = Enable Australia Post



Postal Code Selection = Enable Japan Post



## Postal Code Selection (continued)



Postal Code Selection = Enable IMB



Postal Code Selection = Enable Sweden Post



Postal Code Selection = Enable Portugal Post

## Postnet BB Control

Controls the ability of the reader to decode B and B' fields of Postnet labels.



★ Postnet BB Control = Disable



Postnet BB Control = Enable

# CONFIGURATION | OCR DECODING

The QX25 bar code family is equipped with an Optical Character Recognition feature.

This section describes how to configure the Datalogic bar code reader to enable OCR decoding.

The QX25 models support the following OCR font types:

- OCR-A
- OCR-B
- MICR E13B
- US Currency Serial Number.

In most OCR applications a suitable usage of check digits and the addition of constraints on sub-strings types (e.g. digits-only or letter-only) reduces misdecoding probabilities.

The user can choose between a set of predefined templates (already optimized for decoding) and customizable free templates.

For free templates, as OCR decoding is less reliable than traditional barcode decoding, the reader provides tools to minimize misdecoded labels. As a result, particular care shall be dedicated to the setup of free custom templates to reduce incorrect output.

For more information on how to customize the user templates for your needs, please contact Datalogic Technical Support.

Use one of the following labels to enable one of the predefined templates for OCR decoding.



## OCR Decoding Predefined Templates

The following selections are exclusive, enabling one template automatically disables the others.



★ OCR Predefined Template = Disable OCR Function



OCR Predefined Template = EU Identity Card OCR



OCR Predefined Template = IATA Passport OCR



OCR Predefined Template = Italian Post OCR Payment



OCR Predefined Template = Italian Bank  
Freccia Bank Payment form



OCR Predefined Template = Swiss Driving License OCR

# CONFIGURATION | MOTION FEATURES

SECTION CONTENTS	
<b>MOTION FEATURES</b> starting on page 219	
<ul style="list-style-type: none"><li>• Motionless Timeout</li><li>• Motion Sensitivity</li></ul>	<ul style="list-style-type: none"><li>• High Motion Immunity</li><li>• Motion Aiming Control</li><li>• DOF Enhancement</li></ul>

Use this chapter to configure motion settings for the handheld.  
Reference Appendix B, for a listing of standard factory settings.



## Motionless Timeout

The period of time that must expire without detecting any motion, before the reader is assumed to be in a motionless condition. The selectable setting is from 500 to 25,500 milliseconds in 100 millisecond increments. This option relates to such features as Aimer On and Stand Mode/Object Detection scanning with respect to motion.



Select Motionless Timeout

To configure this feature, scan the ENTER/EXIT PROGRAMMING MODE bar code above, then the bar code at left followed by the digits from the Alphanumeric characters in [Appendix D, Keypad](#) representing your desired character(s). End by scanning the ENTER/EXIT bar code again.

Make a mistake? Scan the CANCEL bar code to abort and not save the entry string. You can then start again at the beginning.



CANCEL

★ 020 = Motionless Timeout = 2 seconds

## Motion Sensitivity

Sets the sensitivity level for motion detection wakeup. Choices are low, medium and high.



Motion Sensitivity = Low



★ Motion Sensitivity = Medium



Motion Sensitivity = High





## High Motion Immunity

When set to triggerless scanning mode (e.g. Flashing, Always On, Stand Mode/Object Detection, etc.) the reading capabilities can be modified according to two main goals:

- increased performance for rapidly moving barcodes - Enable High Motion Immunity:
- increased performance for distant barcodes - Disable High Motion Immunity:

Depending on specific environmental conditions, application requirements, or expected performance, choose the best solution.



★ High Motion Immunity = Disable



High Motion Immunity = Enable

## Motion Aiming Control

Enables/Disables the Aiming system when motion is detected.



Motion Aiming Control = Disable



★ Motion Aiming Control = Enable



## DOF Enhancement

When DOF Enhancement is enabled improves the reading performances.



★ Enhance product DOF = Disable



Enhance product DOF = Enable

# CHAPTER 4

## REFERENCES

This section contains explanations and examples of selected bar code features. See [Configuration with Bar Codes](#), starting on page 18 for the actual bar code labels used to configure the reader.

### SECTION CONTENTS

#### **RS-232 PARAMETERS** on page 224

- Baud Rate
- Data Bits
- Stop Bits
- Parity
- Handshaking Control

#### **RS-232/USB COM PARAMETERS** on page 225

- Intercharacter Delay
- ACK NAK Options
- ACK Character
- NAK Character
- ACK NAK Timeout Value
- ACK NAK Retry Count
- Disable Character
- Enable Character

#### **KEYBOARD INTERFACE** on page 232

- Intercharacter Delay
- Intercode Delay

#### **DATA FORMAT** on page 235

- Data Editing
- Global Prefix/Suffix
- Global AIM ID
- Label ID
- Character Conversion

#### **SCANNING FEATURES** on page 243

- Scan Mode
- Scanning Active Time
- Aiming Duration Time
- Flash On Time
- Flash Off Time

#### **LED AND BEEPER INDICATORS** on page 248

- Good Read LED Duration

#### **SYMBOLOGIES** on page 249

- Set Length

## RS-232 PARAMETERS

### RS-232 ONLY

#### Baud Rate

Baud rate is the number of bits of data transmitted per second. Set the reader's baud rate to match the baud rate setting of the host device. With an improper baud rate setting, data may not reach the host correctly.

#### Data Bits

This parameter allows the reader to interface with devices requiring a 7-bit or 8-bit ASCII protocol for sending and receiving data.

#### Stop Bits

The stop bit(s) at the end of each transmitted character marks the end of transmission of one character and prepares the receiving device for the next character in the serial data stream. The number of stop bits selected (one or two) depends on the number the receiving terminal is programmed to accommodate. Set the number of stop bits to match host device requirements.

#### Parity

This feature specifies parity required for sending and receiving data. A parity check bit is the most significant bit of each ASCII coded character. Select the parity type according to host device requirements.

- Select None when no parity bit is required.
- Select Odd parity and the parity bit value is set to 0 or 1, based on data, to ensure that an odd number of 1 bits are contained in the coded character.
- Select Even parity and the parity bit value is set to 0 or 1, based on data, to ensure that an even number of 1 bits are contained in the coded character.

#### Handshaking Control

The data interface consists of an RS-232 port designed to operate either with or without the hardware handshaking lines, Request to Send (RTS), and Clear to Send (CTS). Handshaking Control includes the following options:

- RTS — RTS is asserted during transmissions. CTS is ignored.
- RTS/CTS — RTS is asserted during transmissions. CTS gates transmissions.
- RTS/XON/XOFF — RTS is asserted during transmissions. CTS is ignored. XON and XOFF gate transmissions.
- RTS On/CTS — RTS is always asserted. CTS gates transmissions.
- RTS/CTS Scan Control — RTS is asserted during transmissions. CTS gates transmissions and controls enable and disable state of reader.

# RS-232/USB COM PARAMETERS

## Intercharacter Delay

This parameter specifies the intercharacter delay between the end of one character and the beginning of the next. The delay can be set within a range of zero (0) to 990 milliseconds in 10ms increments. A setting of zero specifies no delay.

To set the delay:

1. Determine the desired setting in milliseconds.
2. Divide the desired setting by 10 (setting is in 10ms increments). Pad the result with leading zeroes to yield two digits. For example: 0 = 00, 5 = 05, 20 = 20, etc.
3. Scan the ENTER/EXIT PROGRAMMING MODE bar code to enter Programming Mode.
4. Go to [page 27](#) and scan the bar code: SELECT INTERCHARACTER DELAY SETTING.
5. Scan the appropriate two digits from the keypad in [Appendix D](#), that represent the duration which was determined in the steps above. You will hear a two-beep indication after the last character.



**NOTE: If you make a mistake before the last character, scan the CANCEL bar code to abort and not save the entry string. You can then start again at the beginning.**

6. Scan the ENTER/EXIT PROGRAMMING MODE bar code to exit.

This completes the procedure. See the following table for examples of how to set this feature.

**Table 2 - Intercharacter Delay Setting Examples**

STEP	ACTION	EXAMPLES			
1	<b>Desired Setting</b>	50ms	150ms	600ms	850ms
2	<b>Divide by 10 (pad with leading zeroes to yield two-digits)</b>	05	10	60	85
3	<b>Scan ENTER/EXIT PROGRAMMING MODE</b>				
4	<b>Scan SELECT INTERCHARACTER DELAY SETTING</b>				
5	<b>Scan two characters from Appendix D</b>	'0' and '5'	'1' and '5'	'6' and '0'	'8' and '5'
6	<b>Scan ENTER/EXIT PROGRAMMING MODE</b>				

## ACK NAK Options

This enables/disables the ability of the reader to support the RS-232 ACK/NAK protocol. When configured, the reader and/or host sends an “ACK” when it receives data properly, and sends “NAK” when the data is in error.

Options are:

- Disable
- Enable for label transmission — The reader expects an ACK/NAK response from the host when a label is sent
- Enable for host-command acknowledge — The reader will respond with ACK/NAK when the host sends a command
- Enable for label transmission and host-command acknowledge

## ACK Character

This setting specifies an ASCII character or hex value to be used as the ACK character. ASCII characters or any hex value from 0 to 0xFF can be selected.



**NOTE: Setting to previously defined characters such as XON, XOFF, or host commands conflicts with normal operation of these characters. 8-bit data is not recognized when the option Data Bits page 30 has been set as 7 Data Bits.**

1. Determine the desired character or value.
2. Use the ASCII Chart on [page 290](#) to find the hex equivalent for the desired character/value.
3. Scan ENTER/EXIT PROGRAMMING MODE to enter Programming Mode.
4. Scan the bar code: SELECT ACK CHARACTER SETTING.
5. Scan the appropriate two alphanumeric characters from the keypad in [Appendix D](#), that represent the desired character/value determined above. The second character will cause a two-beep indication.
6. Scan the ENTER/EXIT PROGRAMMING MODE bar code to exit.

See the table below for examples of how to set this feature.

**Table 3 - ACK Character Setting Examples**

STEP	ACTION	EXAMPLES			
1	Desired Character/Value	ACK	\$	@	>
2	Hex equivalent from ASCII Chart on page 290	0x06	0x24	0x40	0x3E
3	Scan ENTER/EXIT PROGRAMMING MODE				
4	Scan SELECT ACK CHARACTER SETTING				
5	Scan two characters from Appendix D	'0' and '6'	'2' and '4'	'4' and '0'	'3' AND 'E'
6	Scan ENTER/EXIT PROGRAMMING MODE				

## NAK Character

This setting specifies an ASCII character or hex value to be used as the NAK character. ASCII characters or any hex value from 0 to 0xFF can be selected.



**NOTE: Setting to previously defined characters such as XON, XOFF, or host commands conflicts with normal operation of these characters. 8-bit data is not recognized when the option Data Bits on page 30 has been set as 7 Data Bits.**

To set this feature:

1. Determine the desired character or value.
2. Use the ASCII Chart on [page 290](#) to find the hex equivalent for the desired character/value.
3. Scan the ENTER/EXIT PROGRAMMING MODE bar code to enter Programming Mode.
4. Scan the bar code: SELECT NAK CHARACTER SETTING.
5. Scan the appropriate two alpha-numeric characters from the keypad in [Appendix D](#), that represent the desired character/value determined above. The second character will cause a two-beep indication.
6. Scan the ENTER/EXIT PROGRAMMING MODE bar code to exit Programming Mode.

This completes the procedure. See the table below for examples of how to set this feature.

**Table 4 - NAK Character Setting Examples**

STEP	ACTION	EXAMPLES			
1	Desired Character/Value	NAK	\$	@	>
2	Hex equivalent	0x15	0x24	0x40	0x3E
3	Scan ENTER/EXIT PROGRAMMING MODE				
4	Scan SELECT NAK CHARACTER SETTING				
5	Scan two characters from Appendix D	'1' and '5'	'2' and '4'	'4' and '0'	'3' AND 'E'
6	Scan ENTER/EXIT PROGRAMMING MODE				

## ACK NAK Timeout Value

This option specifies the amount of time the reader waits for an ACK character from the host following label transmission. The selectable timeout range is 200 milliseconds to 15,000ms (15 seconds) in 200ms increments. A selection of 0 disables the timeout.

To set this value:

1. Determine the desired setting in milliseconds.
2. Divide the desired setting by 200 (setting is in 200ms increments). Pad the result with leading zeroes to yield two digits. For example: 0 = 00, 5 = 05, 20 = 20, etc.
3. Scan the ENTER/EXIT PROGRAMMING MODE bar code to enter Programming Mode.
4. Scan the bar code: SELECT ACK NAK TIMEOUT VALUE SETTING.
5. Scan the appropriate two digits from the keypad in [Appendix D](#), that represent the duration which was determined in the steps above. You will hear a two-beep indication after the last character.



**NOTE: If you make a mistake before the last character, scan the CANCEL bar code to abort and not save the entry string. You can then start again at the beginning.**

6. Scan the ENTER/EXIT PROGRAMMING MODE bar code to exit Programming Mode.

This completes the procedure. See the table below for examples of how to set this feature.

**Table 5 - ACK NAK Timeout Value Setting Examples**

STEP	ACTION	EXAMPLES			
1	<b>Desired Setting</b>	200ms	1,000ms (1 sec.)	5200ms (5.2 sec.)	15,000ms (15 sec.)
2	<b>Divide by 200</b>	01	05	26	75
3	<b>Scan ENTER/EXIT PROGRAMMING MODE</b>				
4	<b>Scan SELECT ACK NAK TIMEOUT VALUE SETTING</b>				
5	<b>Scan two characters from Appendix D</b>	'0' and '1'	'0' and '5'	'2' and '6'	'7' AND '5'
6	<b>Scan ENTER/EXIT PROGRAMMING MODE</b>				



## ACK NAK Retry Count

This feature specifies the number of times the reader retries a label transmission due to a retry condition. The selectable range is from 1 to 254 retries. A selection of 0 disables the count, and a selection of 255 specifies unlimited retries.

To set this feature:

1. Determine the desired setting.
2. Pad the number with leading zeroes to yield three digits. For example: 0 = 000, 5 = 005, 20 = 020, etc.
3. Scan the ENTER/EXIT PROGRAMMING MODE bar code to enter Programming Mode.
4. Scan the bar code: SELECT ACK NAK RETRY COUNT SETTING.
5. Scan the appropriate three digits from the keypad in [Appendix D](#), that represent the number which was determined in the steps above. You will hear a two-beep indication after the last character.



**NOTE: If you make a mistake before the last character, scan the CANCEL bar code to abort and not save the entry string. You can then start again at the beginning.**

6. Scan the ENTER/EXIT PROGRAMMING MODE bar code to exit Programming Mode.

This completes the procedure. See the table below for examples of how to set this feature.

**Table 6 - ACK NAK Retry Count Setting Examples**

STEP	ACTION	EXAMPLES			
1	<b>Desired Setting</b>	Disable Retry Count	3 Retries	54 Retries	Unlimited Retries
2	<b>Pad with leading zero(es)</b>	000	003	054	255
3	<b>Scan ENTER/EXIT PROGRAMMING MODE</b>				
4	<b>Scan SELECT ACK NAK RETRY COUNT SETTING</b>				
5	<b>Scan three characters from Appendix D</b>	'0', '0' and '0'	'0', '0' and '3'	'0', '5' and '4'	'2', '5' and '5'
6	<b>Scan ENTER/EXIT PROGRAMMING MODE</b>				

## Disable Character

Specifies the value of the RS-232 host command used to disable the reader.  
 ASCII characters or any hex value from 0 to 0xFF can be selected.



**NOTE: Setting to previously defined characters such as XON, XOFF, or host commands conflicts with normal operation of these characters. 8-bit data is not recognized when the option "Data Bits" on page 23 has been set as 7 Data Bits.**

To set the value:

1. Determine the desired character or value. A setting of 0xFF indicates the Disable Character is not used (not available).
2. Use the ASCII Chart on [page 290](#) to find the hex equivalent for the desired character/value.
3. Scan the ENTER/EXIT PROGRAMMING MODE bar code to enter Programming Mode.
4. Scan the bar code: SELECT DISABLE CHARACTER SETTING on [page 33](#).
5. Scan the appropriate two alphanumeric characters from the keypad in [Appendix D](#), that represent the desired character/value determined above. The second character will cause a two-beep indication.
6. Scan the ENTER/EXIT PROGRAMMING MODE bar code to exit Programming Mode.

This completes the procedure. See the table below for examples of how to set this feature.

**Table 7 -Disable Character Setting Examples**

STEP	ACTION	EXAMPLES			
1	Desired character/value	'd'	'j'	'D'	Disable Command Not Used
2	Hex equivalent from ASCII Chart on page 290	0x64	0x7D	0x44	0xFF
3	Scan ENTER/EXIT PROGRAMMING MODE				
4	Scan SELECT DISABLE CHARACTER VALUE SETTING				
5	Scan three characters from Appendix D	'6' and '4'	'7' and 'D'	'4' and '4'	'F' and 'F'
6	Scan ENTER/EXIT PROGRAMMING MODE				

## Enable Character

Specifies the value of the RS-232 host command used to enable the reader.

ASCII characters or any hex value from 0 to 0xFF can be selected.



**NOTE: Setting to previously defined characters such as XON, XOFF, or host commands conflicts with normal operation of these characters. 8-bit data is not recognized when the option "Data Bits" on page 23 has been set as 7 Data Bits.**

To set the value:

1. Determine the desired character or value. A setting of 0xFF indicates the Enable Character is not used (not available).
2. Use the ASCII Chart in [Appendix F](#) to find the hex equivalent for the desired character/value.
3. Scan the ENTER/EXIT PROGRAMMING MODE bar code to enter Programming Mode.
4. Scan the bar code: SELECT ENABLE CHARACTER SETTING on [page 33](#).
5. Scan the appropriate two alphanumeric characters from the keypad in [Appendix D](#), that represent the desired character/value determined above. The second character will cause a two-beep indication.
6. Scan the ENTER/EXIT PROGRAMMING MODE bar code to exit Programming Mode.

This completes the procedure. See the table below for examples of how to set this feature.

**Table 8 - Enable Character Setting Examples**

STEP	ACTION	EXAMPLES			
1	Desired character/value	'e'	'}	'E'	Enable Command Not Used
2	Hex equivalent from ASCII Chart on page 290	0x65	0x7D	0x45	0xFF
3	Scan ENTER/EXIT PROGRAMMING MODE				
4	Scan SELECT ENABLE CHARACTER VALUE SETTING				
5	Scan two characters from Appendix D	'6' and '5'	'7' and 'D'	'4' and '5'	'F' and 'F'
6	Scan ENTER/EXIT PROGRAMMING MODE				

# KEYBOARD INTERFACE

## Wedge Quiet Interval

Specifies the amount of time the reader looks for keyboard activity before it breaks the keyboard connection in order to transmit data to host. The range is from 0 to 990ms in 10ms increments.



**NOTE: This feature applies ONLY to the Keyboard Wedge interface.**

1. Determine the desired setting in milliseconds.
2. Divide the desired setting by 10 (setting is in 10ms increments). Pad the result with leading zeroes to yield two digits. For example: 0 = 00, 5 = 05, 20 = 20, etc.
3. Go to [page 60](#) and scan the ENTER/EXIT PROGRAMMING MODE bar code to enter Prog. Mode.
4. Scan the bar code: SELECT WEDGE QUIET INTERVAL SETTING on [page 60](#).
5. Scan the appropriate two digits from the keypad in [Appendix D](#), that represent the duration which was determined in the steps above. You will hear a two-beep indication after the last character.



**NOTE: If you make a mistake before the last character, scan the CANCEL bar code to abort and not save the entry string. You can then start again at the beginning.**

6. Scan the ENTER/EXIT PROGRAMMING MODE bar code to exit.

This completes the procedure to set the Wedge Quiet Interval. See the table below for examples of how to set this feature.

**Table 9 - Wedge Quiet Interval Setting Examples**

STEP	ACTION	EXAMPLES			
1	Desired Setting	10ms	150ms	600ms	850ms
2	Divide by 10 (and pad with leading zeroes)	01	15	60	85
3	Scan ENTER/EXIT PROGRAMMING MODE				
4	Scan SELECT WEDGE QUIET INTERVAL SETTING				
5	Scan two characters from Appendix D	'0' and '1'	'1' and '5'	'6' and '0'	'8' and '5'
6	Scan ENTER/EXIT PROGRAMMING MODE				

## Intercharacter Delay

This parameter specifies the intercharacter delay between the end of one character and the beginning of the next. The delay can be set within a range of zero (0) to 990 milliseconds in 10ms increments. A setting of zero specifies no delay.



**NOTE: This feature applies ONLY to the Keyboard Wedge interface.**

To set the delay:

1. Determine the desired setting in milliseconds.
2. Divide the desired setting by 10 (setting is in 10ms increments). Pad the result with leading zeroes to yield two digits. For example: 0 = 00, 5 = 05, 20 = 20, etc.
3. Go to [page 60](#) and scan the ENTER/EXIT PROGRAMMING MODE bar code to enter Programming Mode.
4. Scan the bar code: SELECT INTERCHARACTER DELAY SETTING on [page 60](#).
5. Scan the appropriate two digits from the keypad in [Appendix D](#), that represent the duration which was determined in the steps above. You will hear a two-beep indication after the last character.



**NOTE: If you make a mistake before the last character, scan the CANCEL bar code to abort and not save the entry string. You can then start again at the beginning.**

6. Scan the ENTER/EXIT PROGRAMMING MODE bar code to exit Programming Mode. This completes the procedure. See the table below for examples of how to set this feature.

**Table 10 - Intercharacter Delay Setting Examples**

STEP	ACTION	EXAMPLES			
1	Desired Setting	50ms	150ms	600ms	850ms
2	Divide by 10 (and pad with leading zeroes to yield two-digits)	05	15	60	85
3	Scan ENTER/EXIT PROGRAMMING MODE				
4	Scan SELECT INTERCHARACTER DELAY SETTING				
5	Scan two characters from Appendix D	'0' and '5'	'1' and '5'	'6' and '0'	'8' and '5'
6	Scan ENTER/EXIT PROGRAMMING MODE				

## Intercode Delay

Specifies the delay between labels transmitted to the host for this interface. The selectable range for this feature is from 0 to 99 seconds.

Follow these instructions to set this feature:

1. Determine the desired setting.
2. Pad the number with leading zeroes to yield two digits. For example: 0 = 00, 5 = 05, 20 = 20, etc
3. Go to [page 61](#) and scan the ENTER/EXIT PROGRAMMING MODE bar code to enter Programming Mode.
4. Scan the bar code: SELECT INTERCODE DELAY SETTING on [page 61](#).
5. Scan the appropriate two digits from the keypad in [Appendix D](#), that represent the duration which was determined in the steps above. You will hear a two-beep indication after the last character.



**NOTE: If you make a mistake before the last character, scan the CANCEL bar code to abort and not save the entry string. You can then start again at the beginning.**

6. Scan the ENTER/EXIT PROGRAMMING MODE bar code to exit Programming Mode. This completes the procedure. See the table below for examples of how to set this feature.

**Table 11 - Intercode Delay Setting Examples**

STEP	ACTION	EXAMPLES			
1	<b>Desired Setting</b>	No Delay	5 seconds	60 seconds	99 seconds
2	<b>Pad with leading zero(es)</b>	00	05	60	99
3	<b>Scan ENTER/EXIT PROGRAMMING MODE</b>				
4	<b>Scan SELECT INTERCODE DELAY SETTING</b>				
5	<b>Scan two characters from Appendix D</b>	'0' and '0'	'0' and '5'	'6' and '0'	'9' and '9'
6	<b>Scan ENTER/EXIT PROGRAMMING MODE</b>				

## DATA FORMAT

### Data Editing

When a bar code is scanned, additional information can be sent to the host computer along with the bar code data. This combination of bar code data and supplementary user-defined data is called a “message string.” The Data Editing features can be used to build specific user-defined data into a message string.

There are several types of selectable data characters that can be sent before and after scanned data. You can specify if they should be sent with all symbologies, or only with specific symbologies. The following shows the available elements you can add to a message string:

**Figure 6 - Breakdown of a Message String**

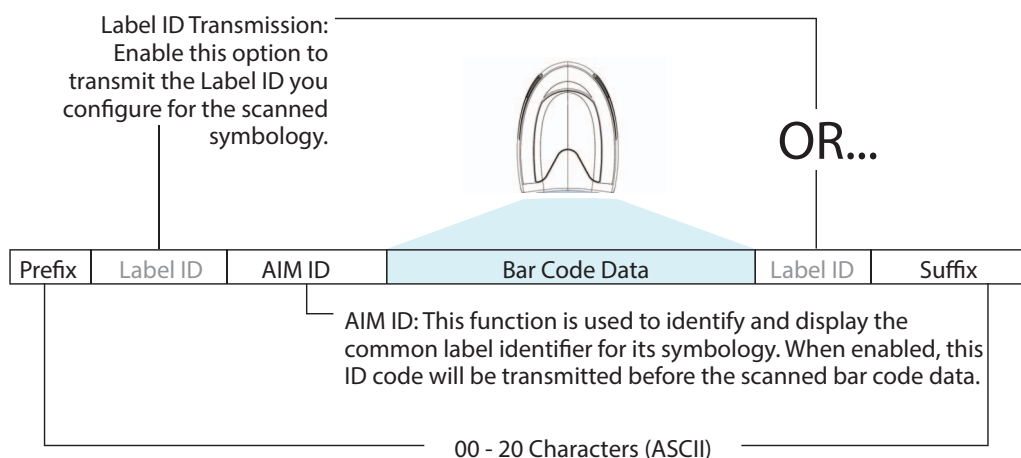

**NOTE: Additional advanced editing is available. See the Advanced formatting features in the Datalogic Aladdin configuration software, or contact "Technical Support" on page xii for more information.**

### Please Keep In Mind...

- Modifying a message string is not a mandatory requirement. Data editing is a sophisticated feature allowing highly customizable output for advanced users. Factory default settings for data editing is typically set to NONE.
- A prefix or suffix may be applied only to a specified symbology (reference [1D Symbologies, starting on page 103](#)) or across all symbologies (set via the Global features in [Configuration with Bar Codes, starting on page 18](#)).
- You can add any character from the ASCII Chart on [page 290](#) (from 00-FF) on the inside back cover of this manual as a prefix, suffix or Label ID.
- Enter prefixes and suffixes in the order in which you want them to appear on the output.

## Global Prefix/Suffix

Up to 20 ASCII characters may be added as a prefix (in a position before the bar code data) and/or as a suffix (in a position following the bar code data) as indicated.

**Figure 7 Prefix and Suffix Positions**

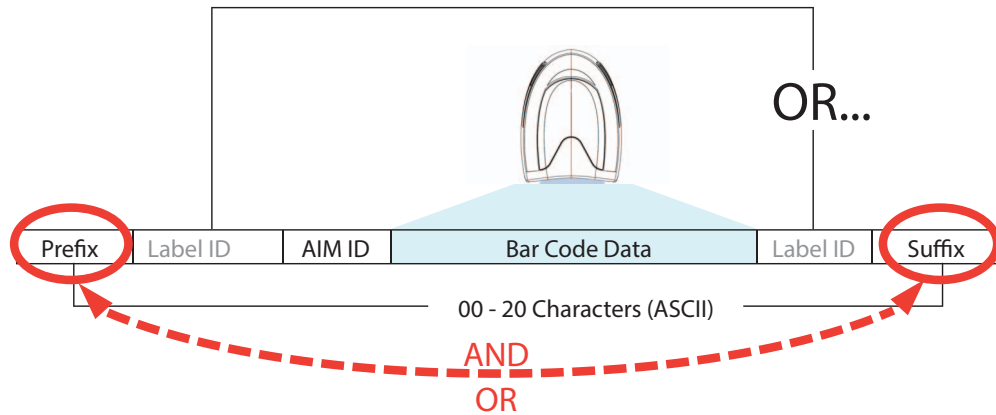

### Example: Setting a Prefix

In this example, we'll set a prefix for all symbologies.

1. Determine which ASCII character(s) are to be added to scanned bar code data. In this example, we'll add a dollar sign ('\$') as a prefix.
2. Scan the ENTER/EXIT PROGRAMMING MODE bar code, then scan the SET GLOBAL PREFIX bar code.
3. Reference the ASCII Chart on [page 290](#) in [Appendix F](#) to find the hex value assigned to the desired character. The corresponding hex number for the '\$' character is 24. To enter this selection code, scan the '2' and '4' bar codes from [Appendix D](#).



**NOTE: If you make a mistake before the last character, scan the CANCEL bar code to abort and not save the entry string. You can then start again at the beginning.**

4. If less than the expected string of 20 characters are selected, scan the ENTER/EXIT bar code to terminate the string.
5. Scan the ENTER/EXIT bar code once again to exit Programming Mode.

The resulting message string would appear as follows:

Scanned bar code data: **12345**

Resulting message string output: **\$12345**



## Global AIM ID



**NOTE:** This feature enables/disables addition of AIM IDs for all symbology types.

AIM label identifiers (as opposed to custom characters you select yourself as with label identifiers) can be included with scanned bar code data. AIM label identifiers consist of three characters as follows:

- A close brace character (ASCII '['), followed by...
- A code character (see the table below), followed by...
- A modifier character (the modifier character is symbol dependent).

SYMBOLGY	CHAR	SYMBOLGY	CHAR
UPC/EAN	E <sup>a</sup>	Code 128/GS1-128	C
Code 39 and Code 32	A	DataBar Omnidirectional, DataBar Expanded	e
Codabar	F	Standard 2 of 5	S
Interleaved 2 of 5	I	ISBN	X <sup>b</sup>
Code 93	G	Code 11	H

- a. UPC-A and UPC-E labels are converted to EAN 13 when adding AIM IDs.  
b. ISBN (X with a 0 modifier character)

**Figure 8 AIM ID**

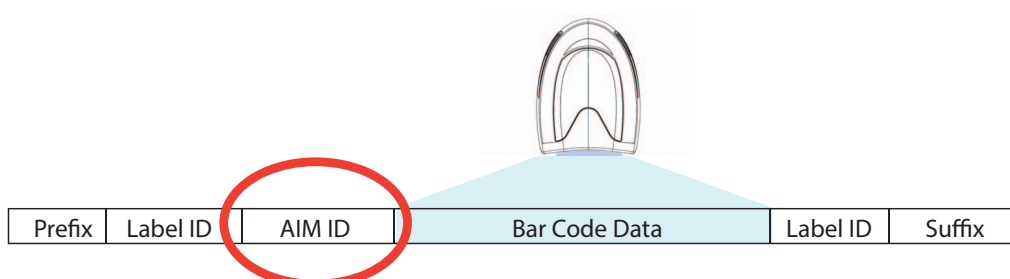

## Label ID

A Label ID is a customizable code of up to three ASCII characters (each can be one of hex 0x01-0xFF), used to identify a bar code (symbology) type. It can be appended previous to or following the transmitted bar code data depending upon how this option is enabled. This feature provides options for configuring custom Label IDs as a pre-loaded set or individually per symbology (see "[Label ID: Set Individually Per Symbology](#)" on page 72). If you wish to program the reader to always include an industry standard label identifier for ALL symbology types, see "[Global AIM ID](#)" on page 70.

### Label ID: Pre-loaded Sets

The following table lists the pre-loaded label ID sets for the USA and Europe.

**Table 12 - Label ID Pre-loaded Sets**

SYMBOLGY	USA LABEL ID SET		EU LABEL ID SET	
	ASCII character	Hex value	ASCII character	Hexadecimal value
ABC Codabar	S	530000	S	530000
CODABAR	%	250000	R	520000
Code 39 CIP HR	Y	590000	Y	590000
Code 93	&	260000	U	550000
Code 11	CE	434500	b	620000
Code 128	#	230000	T	540000
Code 32	A	410000	X	580000
Code 39	*	2A0000	V	560000
Datalogic 2of5	s	730000	s	730000
EAN13	F	460000	B	420000
EAN13 P2	F	460000	L	4C0000
EAN13 P5	F	460000	M	4D0000
EAN8	FF	464600	A	410000
EAN8 P2	FF	464600	J	4A0000
EAN8 P5	FF	464600	K	4B0000
FOLLETT 20F5	O	4F0000	O	4F0000
GS1 DATABAR EXPANDED	RX	525800	t	740000
GS1 DATABAR LIMITED	RL	524C00	v	760000
GS1 DATABAR OMNIDIRECTIONAL	R4	523400	u	750000
GS1-128		000000	k	6B0000
I2OF5	i	690000	N	4E0000
IATA	IA	494100	&	260000
Industrial 2 of 5	W	570000	W	570000
Interleaved 2 of 5	e	650000	e	650000
ISBN	l	490000	@	400000
ISBT128	f	660000	f	660000

SYMBOLGY	USA LABEL ID SET		EU LABEL ID SET	
ISSN	n	6E0000	n	6E0000
MSI	@	400000	Z	5A0000
S25	s	730000	P	500000
UPCA	A	410000	C	430000
UPCA P2	A	410000	F	460000
UPCA P5	A	410000	G	470000
UPCE	E	450000	D	440000
UPCE P2	E	450000	H	480000
UPCE P5	E	450000	I	490000
OCR-A	o	6F0000	\$o	246F00
OCR-B	o	6F0000	\$p	247000
MICR	o	6F0000	\$m	246D00

## Label ID: Set Individually Per Symbology

To configure a Label ID individually for a single symbology:

1. Scan the ENTER/EXIT bar code.
2. Select Label ID position as either BEFORE (Enable as Prefix) or AFTER (Enable as suffix) by scanning the appropriate bar code in the section "Label ID Control" on page 72. Reference Figure 9 for Label ID positioning options if multiple identification features are enabled.
3. Scan a bar code to select the symbology for which you wish to configure a custom Label ID from the section "Label ID Symbology Selection" on page 73.
4. Determine the desired character(s) (you may choose up to three) which will represent the Label ID for the selected symbology.
5. Turn to the ASCII Chart on page 290 on the inside back cover of this manual and find the equivalent hex digits associated with your choice of Label ID. For example, if you wish to select an equal sign (=) as a Label ID, the chart indicates its associated hex characters as 3D. Turn to Keypad, in Appendix D, and scan the bar codes representing the hex characters determined. For the example given, the characters '3' and 'D' would be scanned. More examples of Label ID settings are provided in Table 13 on page 241.



**NOTE: If you make a mistake before the last character, scan the CANCEL bar code to abort and not save the entry string. You can then start again at the beginning.**

6. Scan the ENTER/EXIT bar code to exit Label ID entry.
7. Scan the ENTER/EXIT bar code once again to exit Programming Mode.

This completes the steps to configure a Label ID for a given symbology.

**Figure 9 Label ID Position Options**

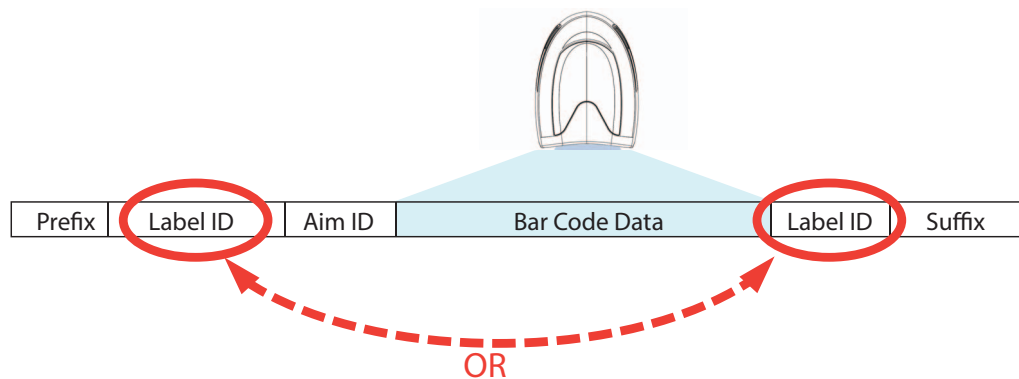

## Label ID: Set Individually Per Symbology — continued

Table 13 Label ID Examples

STEP	ACTION	EXAMPLES			
1	Scan the ENTER/EXIT bar code	(Reader enters Programming Mode)			
2	Determine placement of the Label ID characters BEFORE or AFTER with regard to scanned data using Label ID Control, starting on page 72	Enable as Prefix	Enable as Suffix	Enable as Prefix	Enable as Suffix
3	Scan the bar code selecting the symbology type you wish to designate label ID characters for using Label ID Symbology Selection, starting on page 73	GS1 DataBar Omnidirectional	Code 39	Interleaved 2 of 5	Code 32
4	Custom Label ID example (desired characters):	D B *	= C 3	+	PH
5	Find hex equivalents from the ASCII table (inside back cover), then scan in these digits/characters using the bar codes in the section: Keypad, starting on page 277. If you make a mistake before the last character, scan the CANCEL bar code to abort and not save the entry string. You can then start again at the beginning.	44 42 2A	3D 43 33	2B	50 48
6	Scan the ENTER/EXIT bar code	(Reader exits Label ID entry)			
7	Scan the ENTER/EXIT bar code once again	(Reader exits Programming Mode)			
<b>Result:</b>		DB*[bar code data]	[bar code data]=C3	+ [bar code data]	[bar code data]PH

## Character Conversion

Character conversion is an eight byte configuration item. The eight bytes are 4 character pairs represented in hexadecimal ASCII values. The first character in the pair is the character that will be converted. The second character in the pair is the character to convert to. If the character to convert in a pair is FF, then no conversion is done.

For example, if you have the character conversion configuration item set to the following: 41423132FFFFFFFF

The first pair is 4142 or AB (41 hex is an ASCII capital A, 42 hex is an ASCII capital B) and the second pair is 3132 or 12 (31 hex is an ASCII 1, 32 is an ASCII 2). The other two pairs are FFFF and FFFF.

With the label, AB12BA21, it would look as follows after the character conversion: BB22BB22.

The A characters were converted to B characters and the 1 characters were converted to 2 characters. Nothing is done with the last two character pairs, since they are all FF.

To set Character Conversion:

1. Scan the ENTER/EXIT bar code.
2. Scan the bar code for "[Character Conversion](#)" on [page 69](#)
3. Determine the desired string. Sixteen positions must be determined as in the above example. Next, turn to the ASCII Chart on [page 290](#) on the inside back cover of this manual and find the equivalent hex digits needed to fulfill the string.
4. Turn to [Appendix D](#), Keypad and scan the bar codes representing the hex characters determined in the previous step.
5. Scan the ENTER/EXIT bar code to exit Programming Mode.



**NOTE: If less than the expected string of 16 characters are selected, scan the ENTER/EXIT bar code twice to accept the selections and exit Programming Mode.**

---

# SCANNING FEATURES

## Scan Mode

Selects the scan operating mode for the reader. Selections are:

**Trigger Single:** When the trigger is pulled, scanning is activated until one of the following occurs:

- Stand Mode/Object Detection has elapsed
- a label has been read
- the trigger is released

This mode is associated with typical handheld reader operation: when the trigger is pulled, scanning starts and the product scans until the trigger is released, or a label is read, or the maximum Stand Mode/Object Detection has elapsed.

**Trigger Hold Multiple:** When the trigger is pulled, scanning starts and the product scans until the trigger is released or Stand Mode/Object Detection has elapsed. Reading a label does not disable scanning. [Double Read Timeout](#) prevents undesired multiple reads of the same label while in this mode.

**Trigger Pulse Multiple:** When the trigger is pulled, continuous scanning is activated until Stand Mode/Object Detection has elapsed or the trigger has been released and pulled again. [Double Read Timeout](#) prevents undesired multiple reads of the same label while in this mode.

**Flashing:** The reader flashes<sup>1</sup> on and off regardless of the trigger status. Flash rate is controlled by [Flash On Time](#) and [Flash Off Time](#). When Flash is ON the reader reads continuously. When Flash is OFF scanning is deactivated.

**Always On:** No trigger pull is required to read a bar code. Scanning is continually on. [Double Read Timeout](#) prevents undesired multiple reads of the same label while in this mode.

**Stand Mode/Object Detection:** No trigger pull is required to read a bar code. Scanning turns on automatically when an item is placed in reader's field of view. While in a stand watch state, the reader illumination LED goes from dim to maximum bright.

---

1. Controlled by [Flash On Time](#).

## Scanning Active Time

This setting specifies the amount of time that the reader stays in scan ON state once the state is entered. The range for this setting is from 1 to 255 seconds in 1-second increments.

Follow these instructions to set this feature:

1. Determine the desired setting.
2. Pad the result with leading zeroes to yield three digits. For example: 0 = 000, 5 = 005, 20 = 020, etc.
3. Scan the ENTER/EXIT PROGRAMMING MODE bar code to enter Programming Mode.
4. Scan the bar code: SELECT SCANNING ACTIVE TIME SETTING on [page 80](#).
5. Scan the appropriate three digits from the keypad in [Appendix D](#), that represent the duration which was determined in the steps above. You will hear a two-beep indication after the last character.



**NOTE: If you make a mistake before the last character, scan the CANCEL bar code to abort and not save the entry string. You can then start again at the beginning.**

6. Scan the ENTER/EXIT PROGRAMMING MODE bar code to exit Programming Mode. This completes the procedure. See the table below for examples of how to set this feature.

**Table 14 Scanning Active Time Setting Examples**

STEP	ACTION	EXAMPLES			
1	Desired Setting	1 Second	90 Sec. (1.5 min.)	180 Sec. (3 min.)	255 Seconds (4.25 min.)
2	Pad leading zero(es)	001	090	180	255
3	Scan ENTER/EXIT PROGRAMMING MODE				
4	Scan SELECT SCANNING ACTIVE TIME SETTING				
5	Scan three characters from Appendix D	'0', '0' and '1'	'0', '9' and '0'	'1', '8' and '0'	'2', '5' and '5'
6	Scan ENTER/EXIT PROGRAMMING MODE				



## Aiming Duration Time

Specifies the frame of time the aiming pointer remains on after decoding a label, when in trigger single mode. The range for this setting is from 1 to 255 seconds in 1-second increments.

Follow these instructions to set this feature:

1. Determine the desired setting.
2. Pad the result with leading zeroes to yield three digits. For example: 0 = 000, 5 = 005, 20 = 020, etc.
3. Scan the ENTER/EXIT PROGRAMMING MODE bar code to enter Programming Mode.
4. Scan the bar code: SELECT AIMING DURATION TIME SETTING.
5. Scan the appropriate two digits from the keypad in [Appendix D](#), that represent the duration which was determined in the steps above. You will hear a two-beep indication after the last character.



**NOTE: If you make a mistake before the last character, scan the CANCEL bar code to abort and not save the entry string. You can then start again at the beginning.**

6. Scan the ENTER/EXIT PROGRAMMING MODE bar code to exit Programming Mode.

This completes the procedure. See the following table for some examples of how to set this feature.

**Table 15 Aiming Duration Time Setting Examples**

STEP	ACTION	EXAMPLES			
1	<b>Desired Setting</b>	1 Second	90 Sec. (1.5 min.)	180 Sec. (3 min.)	255 Seconds (4.25 min.)
2	<b>Pad leading zero(es)</b>	001	090	180	255
3	<b>Scan ENTER/EXIT PROGRAMMING MODE</b>				
4	<b>Scan SELECT AIMING DURATION TIME SETTING</b>				
5	<b>Scan three characters from Appendix D</b>	'0', '0' and '1'	'0', '9' and '0'	'1', '8' and '0'	'2', '5' and '5'
6	<b>Scan ENTER/EXIT PROGRAMMING MODE</b>				

## Flash On Time

This feature specifies the ON time for the indicator LED while in Flash Mode. The selectable range is 100 to 9,900 milliseconds (0.1 to 9.9 seconds), in 100 millisecond increments.

Follow these instructions to set this feature.

1. Determine the desired setting in milliseconds.
2. Divide the desired setting by 100 (setting is in 100ms increments). Pad the result with leading zeroes to yield two digits. For example: 0 = 00, 5 = 05, 20 = 20, etc.
3. Scan the ENTER/EXIT PROGRAMMING MODE bar code to enter Programming Mode.
4. Scan the bar code: SELECT FLASH ON TIME SETTING on [page 80](#).
5. Scan the appropriate two digits from the keypad in [Appendix D](#), that represent the duration which was determined in the steps above. You will hear a two-beep indication after the last character.



**NOTE: If you make a mistake before the last character, scan the CANCEL bar code to abort and not save the entry string. You can then start again at the beginning.**

6. Scan the ENTER/EXIT PROGRAMMING MODE bar code to exit Programming Mode.

This completes the procedure. See the following table for examples of how to set this feature.

**Table 16 Flash On Time Setting Examples**

STEP	ACTION	EXAMPLES			
1	Desired Setting	500ms	1,000ms (1 sec.)	5200ms (5.2 sec.)	9,900ms (9.9 sec.)
2	Divide by 100 (and pad with leading zeroes to yield two digits)	05	10	52	99
3	Scan ENTER/EXIT PROGRAMMING MODE				
4	Scan SELECT FLASH ON TIME SETTING				
5	Scan two characters from Appendix D	'0' and '5'	'1' and '0'	'5' and '2'	'9' and '9'
6	Scan ENTER/EXIT PROGRAMMING MODE				

## Flash Off Time

This feature specifies the OFF time for the indicator LED while in Flash Mode. The selectable range is 100 to 9,900 milliseconds (0.1 to 9.9 seconds), in 100 millisecond increments.

Follow these instructions to set this feature.

1. Determine the desired setting in milliseconds.
2. Divide the desired setting by 100 (setting is in 100ms increments). Pad the result with leading zeroes to yield two digits. For example: 0 = 00, 5 = 05, 20 = 20, etc.
3. Scan the ENTER/EXIT PROGRAMMING MODE bar code to enter Programming Mode.
4. Scan the bar code: SELECT FLASH OFF TIME SETTING on [page 81](#).
5. Scan the appropriate two digits from the keypad in [Appendix D](#), that represent the duration which was determined in the steps above. You will hear a two-beep indication after the last character.



**NOTE: If you make a mistake before the last character, scan the CANCEL bar code to abort and not save the entry string. You can then start again at the beginning.**

6. Scan the ENTER/EXIT PROGRAMMING MODE bar code to exit Programming Mode.

This completes the procedure. See the following table for examples of how to set this feature.

**Table 17 Flash Off Time Setting Examples**

STEP	ACTION	EXAMPLES			
1	<b>Desired Setting</b>	500ms	1,000ms (1 sec.)	5200ms (5.2 sec.)	9,900ms (9.9 sec.)
2	<b>Divide by 100 (and pad with leading zeroes to yield two digits)</b>	05	10	52	99
3	<b>Scan ENTER/EXIT PROGRAMMING MODE</b>				
4	<b>Scan SELECT FLASH OFF TIME SETTING</b>				
5	<b>Scan two characters from Appendix D</b>	'0' and '5'	'1' and '0'	'5' and '2'	'9' and '9'
6	<b>Scan ENTER/EXIT PROGRAMMING MODE</b>				

# LED AND BEEPER INDICATORS

## Good Read LED Duration

This feature specifies the amount of time that the Good Read LED remains on following a good read. The good read LED on time can be set within a range of 10 milliseconds to 2,550 milliseconds (0.001 to 2.55 seconds) in 100ms increments.

Follow these instructions to set this feature:

1. Determine the desired setting in milliseconds. A setting of 0 means that the good read LED stays on until the next time the trigger is pulled.
2. Divide the desired setting by 10 (setting is in 100ms increments). Pad the result with leading zeroes to yield three digits. For example: 0 = 000, 5 = 000, 20 = 020, etc.
3. Go to [page 93](#) and scan the ENTER/EXIT PROGRAMMING MODE bar code to enter Programming Mode.
4. Scan the bar code: SELECT GOOD READ LED DURATION SETTING.
5. Scan the appropriate two digits from the keypad in [Appendix D](#), that represent the duration which was determined in the steps above. You will hear a two-beep indication after the last character.



**NOTE: If you make a mistake before the last character, scan the CANCEL bar code to abort and not save the entry string. You can then start again at the beginning.**

6. Scan the ENTER/EXIT PROGRAMMING MODE bar code to exit Programming Mode. This completes the procedure. See the following table for some examples of how to set this feature.

**Table 18 Good Read LED Duration Setting Example**

STEP	ACTION	EXAMPLES			
1	<b>Desired Setting</b>	Good Read LED stays on until next trigger pull (00)	20ms	150ms	2550ms (2.55 sec.)
2	<b>Divide by 10 (and pad with leading zeroes)</b>	000	002	015	255
3	<b>Scan ENTER/EXIT PROGRAMMING MODE</b>				
4	<b>Scan SELECT GOOD READ LED DURATION SETTING</b>				
5	<b>Scan three characters from Appendix D</b>	'0', '0' and '0'	'0', '0' and '2'	'0', '1' and '5'	'2', '5' and '5'
6	<b>Scan ENTER/EXIT PROGRAMMING MODE</b>				

# SYMBOLOGIES

## Set Length

Length Control allows you to select either variable length decoding or fixed length decoding for the specified symbology.

**Variable Length:** For variable length decoding, a minimum and maximum length may be set.

**Fixed Length:** For fixed length decoding, two different lengths may be set.

### Set Length 1

This feature specifies one of the bar code lengths for a given symbology. Length 1 is the minimum label length if in Variable Length Mode, or the first fixed length if in Fixed Length Mode.

Reference the [1D Symbologies, starting on page 103](#) to view the selectable range (number of characters) for the symbology being set.

Follow these instructions to set this feature:

1. Determine the desired character length. Pad the number with leading zeroes to yield two digits. For example: 0 = 00, 5 = 05, 20 = 20, etc.
2. Scan the ENTER/EXIT PROGRAMMING MODE bar code to enter Programming Mode.
3. Scan the "Select Length 1 Setting" for the symbology being set.
4. Scan the appropriate two digits from the keypad in [Appendix D](#), that represent the length setting which was determined in the steps above. You will hear a two-beep indication after the last character.



**NOTE: If you make a mistake before the last character, scan the CANCEL bar code to abort and not save the entry string. You can then start again at the beginning.**

5. Scan the ENTER/EXIT PROGRAMMING MODE bar code to exit Programming Mode. This completes the procedure. See the following table for examples of how to set this feature.

**Table 19 Length 1 Setting Examples**

STEP	ACTION	EXAMPLES			
1	<b>Desired Setting</b>	01 Character	07 Character	52 Character	74 Character
2	<b>Scan ENTER/EXIT PROGRAMMING MODE</b>				
3	<b>Scan SELECT LENGTH 1 SETTING for the desired symbology</b>				
4	<b>Scan two characters from Appendix D</b>	'0' and '1'	'0' and '7'	'5' and '2'	'7' AND '4'
5	<b>Scan ENTER/EXIT PROGRAMMING MODE</b>				

## Set Length 2

This feature specifies one of the bar code lengths for a given symbology. Length 2 is the maximum label length if in Variable Length Mode, or the second fixed length if in Fixed Length Mode.

Reference the [1D Symbologies, starting on page 103](#) to view the selectable range (number of characters) for the symbology being set. A setting of 00 specifies to ignore this length (only one fixed length).

Follow these instructions to set this feature:

1. Determine the desired character length. Pad the number with leading zeroes to yield two digits. For example: 0 = 00, 5 = 05, 20 = 20, etc.
2. Scan the ENTER/EXIT PROGRAMMING MODE bar code to enter Programming Mode.
3. Scan the “Select Length 2 Setting” for the symbology being set.
4. Scan the appropriate two digits from the keypad in [Appendix D](#), that represent the length setting which was determined in the steps above. You will hear a two-beep indication after the last character.



**NOTE: If you make a mistake before the last character, scan the CANCEL bar code to abort and not save the entry string. You can then start again at the beginning.**

5. Scan the ENTER/EXIT PROGRAMMING MODE bar code to exit Programming Mode.

This completes the procedure. See the following table for examples of how to set this feature.

**Table 20 Length 2 Setting Examples**

STEP	ACTION	EXAMPLES			
1	<b>Desired Setting</b>	00 (ignore second length)	07 Character	52 Character	74 Character
2	<b>Scan ENTER/EXIT PROGRAMMING MODE</b>				
3	<b>Scan SELECT LENGTH 2 SETTING</b>				
4	<b>Scan two characters from Appendix D</b>	'0' and '0'	'0' and '7'	'5' and '2'	'7' AND '4'
5	<b>Scan ENTER/EXIT PROGRAMMING MODE</b>				

# APPENDIX A

## TECHNICAL SPECIFICATIONS

The table below contains Physical and Performance Characteristics, User Environment and Regulatory information. Table 25 provides Standard Cable Pinouts.

### QD2590 TECHNICAL SPECIFICATIONS

Table 21 QD2590 Technical Specifications

ELECTRICAL CHARACTERISTICS	
Power Supply	QD2590: 5 VDC +/- 5%
Consumption	Operating (Typical): <450mA@5V Standby/Idle (Typical): <90mA@5V
Max. Scan Rate	60 frames/sec
Reading Indicators	Top illumination, Good Read Spot, Beep
OPTICAL CHARACTERISTICS	
Optical Format	1/4"
Active Imager Size	3896 um (H) x 2453 um (V)
Active Pixels	1280 H x 800 V
Illumination System	LED source Red Emission (Wavelength - 617nm) LED source Blue Emission (Wavelength - 470nm)
Ambient Light Up to	100,000 lux
Tilt Tolerance <sup>a</sup>	0° - 360°
Pitch Tolerance <sup>a</sup>	+/- 65°
Skew Tolerance <sup>a</sup>	+/- 65°
Field of View <sup>a</sup>	35° H x 22° V
PCS (Datalogic Test Chart)	minimum 15%

ENVIRONMENTAL CHARACTERISTICS	
<b>Operating Temperature</b>	0 °C to + 50 °C (+32° F to +122 °F)
<b>Storage Temperature</b>	-40 °C to + 70 °C (-40 ° F to +158 °F)
<b>Humidity</b>	95% non condensing
<b>Drop Resistance</b>	IEC 68-2-32 Tested 1.8 m (6 ft)
<b>ESD Protection</b>	16 KV
<b>Protection Class</b>	IP52
<b>Cable Length</b>	Refer to <a href="http://www.datalogic.com">www.datalogic.com</a>
PHYSICAL CHARACTERISTICS	
<b>Color</b>	Black White
<b>Dimensions</b>	Gun only (L/H/W): 10.9 x 16.6 x 6.8 cm (4.3" x 6.5" x 2.7") In Stand: (L/H/W): 7.5 x 21 x 10.9 cm (2.9" x 8.2" x 4.2")
<b>Weight (without cable)</b>	QD2590 approx. 145gr. (5.1 oz.)

a. Based on ISO 15423 specifications



# COMMON READING CHARACTERISTICS

**Table 22 Reading Characteristics**

DOF - DEPTH OF FIELD (TYPICAL) <sup>A, B</sup>	
Symbology	DOF range
Code 39	5 mil: -0.5 - 25.0 cm (0.19" - 9.8") 10 mil: 0.5 - 38 cm (0.19" - 14.9")
EAN13	13 mil: 0.5 - 41.0 cm (0.19" - 16.1")
PDF417	6.7 mil: 0.5 - 21.0 cm (0.19" - 8.3")
Datamatrix	10 mil: 0.5- 21.5 cm (0.19" - 8.5")
Code 128	5 mil: 2 - 21.5 cm (0.8" - 8.5")
QR Code	20 mil: 0- 37 cm (0" - 14.6")
Max Resolution	1D Min = 3 mil PDF417 Min = 3 mil Datamatrix Min = 5 mil

- a. 13 mils DOF based on EAN. All other 1D codes are Code 39. All labels grade A, typical environmental light, 20°C, label inclination 10°  
b. The values are obtained with the item "DOF Enhancement" enabled.

# DECODING CAPABILITIES

DECODE CAPABILITY
<p><b>1D Bar Codes</b></p> <p>UPC/EAN/JAN (A, E, 13, 8); UPC/EAN/JAN (including P2 /P5); UPC/EAN/JAN (including; ISBN / Bookland &amp; ISSN); UPC/EAN Coupons;</p> <p>Code 39 (including full ASCII); Code 39 Trioptic; Code39 CIP HR (French Pharmaceutical); LOGMARS (Code 39 w/ standard check digit enabled); Danish PPT; Code 32 (Italian Pharmacode 39);</p> <p>Code 128; Code 128 ISBT;</p> <p>Interleaved 2 of 5; Standard 2 of 5; Interleaved 2 of 5 CIP (HR); Interleaved 2 of 5 Febraban (for desk models only); Industrial 2 of 5; Discrete 2 of 5; Datalogic 2 of 5 (China Post Code/ Chinese 2 of 5); IATA 2 of 5 Air cargo code; Follet 2 of 5;</p> <p>Codabar; Codabar (NW7); ABC Codabar;</p> <p>Code 11; Code 93; MSI; PZN; Plessey; Anker Plessey;</p> <p>GS1 DataBar Limited; GS1 DataBar Expanded; GS1 DataBar Truncated; DATABAR Expanded Coupon.</p>
<p><b>2D Stacked Codes</b></p> <p>The QuickScan QD2590 family is capable of decoding the following symbologies using multiple frames (i.e. Multi-Frame Decoding):</p> <p>Datamatrix; Inverse Datamatrix; Datamatrix is configurable for the following parameters:; Normal or Inverted; Square or Rectangular Style; Data length (1 - 3600 characters); Maxicode; QR Codes (QR, Micro QR and Multiple QR Codes); Aztec;</p> <p>Postal Codes - (Australian Post; Japanese Post; KIX Post; Planet Code; Postnet; Royal Mail Code (RM45CC); Intelligent Mail Barcode (IMB); Sweden Post; Portugal Post); LaPoste A/R 39; PDF-417; MacroPDF; Micro PDF417; GS1 Composites (1 - 12); French CIP13<sup>a</sup>; GS1 DataBar Stacked; GS1 DataBar Stacked Omnidirectional; GS1 DataBar Expanded Stacked; GS1 Databar Composites; GS1 DotCode;</p> <p>Chinese Sensible Code; Inverted 2D codes<sup>b</sup>.</p>

- a. It is acceptable to handle this with ULE.
- b. The SW can apply the Normal/Reverse Decoding Control to the following symbologies: Datamatrix, QR, Micro QR, Aztec and Chinese Sensible Code.

## LED AND BEEPER INDICATIONS

The reader's beeper sounds and its illumination flashes or changes color to indicate various functions or errors on the reader. A "Green Spot" also lights to indicate a good read. The tables below list these indications.

**Table 23 LED and Beeper Indications**

INDICATION	LED	BEEPER
Power-up	Upper LED flashes/blinks on power-up, however, this may be too rapid to view. With a USB interface, the LED blinks until enumeration with the host is completed.	Reader beeps four times at highest frequency and volume upon power-up.
Good Read	Upper green LED comes on for programmed time (default). LED behavior for this indication is configurable using Aladdin utility.	One beep at current frequency, volume, mono/bi-tonal setting upon a successful label scan. It is also possible to upload custom jingles with Aladdin.
ROM Failure	200 msec on ↔ 200 msec off	Reader sounds one error beep at highest volume for 200 msec.
Limited Scanning Label Read	N/A	Reader 'chirps' six times at the highest frequency and current volume.
Reader Disabled	The LED blinks continuously 100 msec on ↔ 900 msec off	N/A

## USER INDICATIONS FOR QD2590

**Table 24 User Indications for QD2590**

STATUS	TOP LED AND GOOD READ LED	BUZZER
Power-up	OFF	Rising Beeps' Sequence
USB Enumeration Phase	250 msec <sup>a</sup> ON ↔ 250 msec OFF	OFF
USB Suspend	Depends on Power Cable and specific configurations	OFF
Idle	OFF	OFF
While Reading	OFF	OFF
Decode Done	Solid ON Programmable Duration (1 s default)	Single Beep
Reader Disabled (POS) Communication with host not established	100 msec ON ↔ 900 msec OFF	OFF
Firmware Upgrade	250 msec ON ↔ 250 msec OFF	OFF
Host Download	250 msec ON ↔ 250 msec OFF	OFF
Enter Service Mode	No Effect	Beeps' Sequence
Label Programming	No Effect	Beep

a. "msec" stands for milliseconds, equivalent to 1/1000th of a second

## PROGRAMMING MODE

The following indications ONLY occur when the reader is in Programming Mode.

INDICATION	DESCRIPTION	LED	BEEPER
<b>Enter Programming Mode</b>	A valid programming label has been scanned.	LED blinks continuously	Reader sounds four low frequency beeps.
<b>Rejection of Label</b>	Label has been rejected.	N/A	Reader sounds three times at lowest frequency & current volume.
<b>Acceptance of Partial Label</b>	In cases where multiple labels must be scanned to program one feature, this indication acknowledges each portion as it is successfully scanned.	N/A	Reader sounds one short beep at highest frequency & current volume.
<b>Acceptance of Programming</b>	Configuration option(s) have been successfully programmed via labels and the reader has exited Programming Mode.	N/A	Reader sounds one high frequency beep and four low frequency beeps followed by reset beeps.
<b>Cancel Item Entry</b>	Cancel label has been scanned.	N/A	Reader sounds twice at low frequency & current volume.

## TROUBLESHOOTING

PROBLEM	POSSIBLE CAUSE	POSSIBLE SOLUTION
<b>Nothing happens when the scan button is pulled.</b>	No power to the reader	Check system power. Ensure power supply is connected.
	Interface or power cables are loose.	Ensure all cable connections are secure.
<b>LED comes on but bar code does not decode.</b>	Reader not programmed for correct bar code type.	Ensure reader is programmed to read the type of bar code scanned.
	Bar code label is unreadable.	Check the label to ensure it is not defaced. Try scanning another bar code type.
	Distance between reader and bar code is incorrect.	Move reader closer to or further from the bar code.
<b>Bar code is decoded but not transmitted to the host.</b>	Reader not programmed for the correct host type.	Scan the appropriate host type bar code.

Figure 10 and Table 25 provide standard pinout information for the reader's cable.

**Figure 10 Standard Cable Pinouts**

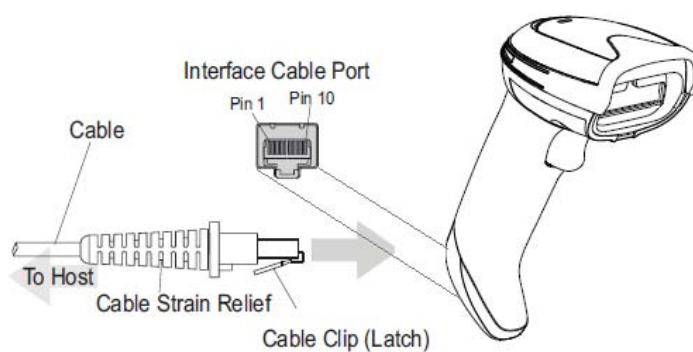

The signal descriptions in Table 25 apply to the connector on the reader and are for reference only.

**Table 25 Standard Cable Pinouts — Reader Side**

PIN	RS232	USB
1	RTS (out)	
2		D+
3		D-
4	GND	GND
5	RX	
6	TX	
7	VCC	VCC
8		
9		
10	CTS (in)	

# APPENDIX B

## STANDARD DEFAULTS

The most common configuration settings are listed in the “Default” column of the table below. Page references are also provided for feature descriptions and programming bar codes for each parameter. A column has also been provided for recording of your preferred default settings for these same configurable features.

**Table 26 Standard Defaults**

PARAMETERS	DEFAULT	YOUR SETTING	PAGE NUMBER
<b>GLOBAL INTERFACE FEATURES</b>			
Host Commands — Obey/Ignore	Obey		20
USB Suspend Mode	Enable		20
<b>RS-232 ONLY</b>			
Baud Rate	9600		22
Data Bits	8 Data Bits		23
Stop Bits	1 Stop Bit		23
Parity	None		24
Handshaking Control	RTS		25
<b>RS-232/USB-COM</b>			
Intercharacter Delay	No Delay		27
Beep On ASCII BEL	Disable		28
Beep On Not on File	Enable		28
ACK NAK Options	Disable		29
ACK Character	‘ACK’		30
NAK Character	‘NAK’		30
ACK NAK Timeout Value	200 msec		31
ACK NAK Retry Count	3 Retries		30
ACK NAK Error Handling	Ignore Errors Detected		32

PARAMETERS	DEFAULT	YOUR SETTING	PAGE NUMBER
Indicate Transmission Failure	Enable		32
Disable Character	'D'		33
Enable Character	'E'		33
<b>KEYBOARD WEDGE</b>			
Setting Country Mode	U.S. Keyboard		36
Encoding Type	Don't Use Encoding		50
ALT Output Type	ALT Unicode		57
Caps Lock State	Caps Lock OFF		58
Numlock	Numlock Key Unchanged		58
Keyboard Numeric Keypad	Standard Keys		59
Keyboard Send Control Characters	Send Ctrl+Key		59
Wedge Quiet Interval	10 = Quiet Interval of 100 msec		60
Intercharacter Delay	00 = No Intercharacter Delay		60
Intercode Delay	00 = No Wedge Intercode Delay		61
USB Keyboard Speed	1ms		62
<b>USB OEM</b>			
USB-OEM Device Usage	Handheld		64
<b>IBM 46XX INTERFACE</b>			
IBM 46xx Interface Options	Obey Reader Configuration Host Commands		66
<b>DATA FORMAT</b>			
Global Prefix/Suffix	No Global Prefix Global Suffix = 0x0D (CR)		68
Case Conversion	Disable (no case conversion)		69
Character Conversion	0xFFFFFFFFFFFFFFFF (no character conversion)		69
Global AIM ID	Disable		70
GS1-128 AIM ID	Disable		70
Label ID: Pre-loaded Sets	USA Set		71
Label ID Control	Disable		72
Label ID Symbology Selection			73
<b>READING PARAMETERS</b>			

## STANDARD DEFAULTS

PARAMETERS	DEFAULT	YOUR SETTING	PAGE NUMBER
Scan Mode	Trigger Simple		79
Scanning Active Time	5 seconds		80
Flash On Time	10 = Flash is ON for 1 second		80
Flash Off Time	06 = Flash is OFF for 600ms		81
Double Read Timeout	0.6 second		81
Stand /Base Detection Behavior	Switch to Stand Mode/Object Detection		83
Stand Mode/Object Detection Indication (Stand Mode Flash)	Disable		84
Stand Mode/Object Detection Sensitivity	Medium		84
Stand Mode/Object Detection Illumination Off Time	1 second		85
Corded Stand Mode	Disable		85
Dock Detection Beep	Disable		86
Power On Alert	Power-up Beep		87
Good Read Beep Type	Mono		87
Good Read Beep Frequency	High		88
Good Read Beep Length	80 msec		89
Good Read Beeper Volume / Vibration	High		90
Silent Mode	Disable		91
RGB Good Read Enable	Enable		91
RGB Good Read Color	GREEN		92
Good Read LED Duration	300 msec		93
Good Read: When to Indicate	After Decode		94
Green Spot Duration	Short (300 msec)		95
Illuminator Intensity	High		96
Aiming Pointer	Enable		97
Aiming Duration Timer	Aiming Off After Decoding		97
Pick Mode	Disable		98
Mobile Phone Mode	Enable		98
Mobile Phone Saturation Rate	00		99
Decode Negative Image	Disable		100



PARAMETERS	DEFAULT	YOUR SETTING	PAGE NUMBER
Multiple Labels per Frame	Disable		101
Multiple Labels Ordering by Code Symbology	Random Order		101
Multiple Labels Ordering by Code Length	Disable		102
<b>CODE SELECTION - 1D SYMBOLOGIES</b>			
<b>Code EAN/UPC</b>			
Coupon Control	Enable only UPC/EAN		104
<b>UPC-A</b>			
UPC-A Enable/Disable	Enable		105
UPC-A Check Character Transmission	Send		105
Expand UPC-A to EAN-13	Don't expand		106
UPC-A Number System Character Transmission	Transmit		106
<b>UPC-E</b>			
UPC-E Enable/Disable	Enable		107
UPC-E Check Character Transmission	Send		107
Expand UPC-E to EAN-13	Don't expand		108
Expand UPC-E to UPC-A	Don't expand		108
UPC-E Number System Character Transmission	Transmit		108
<b>GTIN</b>			
GTIN Formatting	Disable		109
<b>EAN 13 (Jan 13)</b>			
EAN-13 Enable/Disable	Enable		110
EAN-13 Check Character Transmission	Send		110
EAN-13 Flag 1 Character	Transmit		111
EAN-13 to ISBN Conversion	Disable		111
<b>ISSN</b>			
EAN-13 to ISSN Conversion	Disable		112
<b>EAN 8</b>			

PARAMETERS	DEFAULT	YOUR SETTING	PAGE NUMBER
EAN-8 Enable/Disable	Enable		113
EAN-8 Check Character Transmission	Send		113
Expand EAN-8 to EAN-13	Don't Expand		114
<b>UPC/EAN Global Settings</b>			
UPC/EAN Price Weight Check	Disable		115
UPC/EAN Quiet Zones	Two Modules		116
<b>ADD-ONS</b>			
Optional Add-ons	Disable P2 and P5		117
Optional Add-On Timer	70 msec		118
<b>GS1 DATABAR™ OMNIDIRECTIONAL</b>			
GS1 DataBar Omnidirectional Enable/Disable	Disable		119
GS1 DataBar Omnidirectional to GS1-128 Emulation	Disable		119
GS1 DataBar Expanded Enable/Disable	Disable		120
GS1 DataBar Expanded to GS1-128 Emulation	Disable		120
GS1 DataBar Expanded Length Control	Variable		121
GS1 DataBar Expanded Set Length 1	1		121
GS1 DataBar Expanded Set Length 2	74		122
<b>GS1 DATABAR™ LIMITED</b>			
GS1 DataBar Limited Enable/Disable	Disable		123
GS1 DataBar Limited to GS1-128 Emulation	Disable		123
<b>CODE 39</b>			
Code 39 Enable/Disable	Enable		124
Code 39 Check Character Calculation	Don't calculate		124
Code 39 Check Character Transmission	Send		125
Code 39 Start/Stop Character Transmission	Don't transmit		125
Code 39 Full ASCII	Disable		126

PARAMETERS	DEFAULT	YOUR SETTING	PAGE NUMBER
Code 39 Quiet Zones	Small Quiet Zones on two sides		126
Code 39 Length Control	Variable		127
Code 39 Set Length 1	1		127
Code 39 Set Length 2	50		128
<b>TRIOPTIC CODE</b>			
Trioptic Code Enable/Disable	Disable		129
<b>CODE 39 DANISH PPT</b>			
Code 39 Danish PPT Enable/Disable	Disable		129
<b>CODE 39 PZN</b>			
Code 39 PZN Enable/Disable	Disable		130
<b>CODE 39 LA POSTE</b>			
Code 39 La Poste Enable/Disable	Disable		130
<b>CODE 32 (Italian Pharmaceutical Code)</b>			
Code 32 Enable/Disable	Disable		131
Code 32 Check Character Transmission	Don't Send		131
Code 32 Start/Stop Character Transmission	Don't Transmit		132
<b>Code 39 CIP HR (French Pharmaceutical Code)</b>			
Code 39 CIP HR Enable/Disable	Disable		132
<b>SPECIAL CODES</b>			
<b>Code 128</b>			
Code 128 Enable/Disable	Enable		133
Expand Code 128 to Code 39	Don't Expand		133
Code 128 Check Character Transmission	Don't Send		134
Code 128 Function Character Transmission	Don't Send		134
Code 128 Quiet Zones	Auto		135
Code 128 Length Control	Variable		135
Code 128 Set Length 1	1		136
Code 128 Set Length 2	80		136
<b>GS1-128</b>			

PARAMETERS	DEFAULT	YOUR SETTING	PAGE NUMBER
GS1-128 Enable	Transmit in Code 128 Data Format		137
<b>INTERLEAVED 2 of 5</b>			
I 2 of 5 Enable/Disable	Disable		138
I 2 of 5 Check Character Calculation	Disable		139
I 2 of 5 Check Character Transmission	Send		140
I 2 of 5 Length Control	Variable		141
I 2 of 5 Set Length 1	6		141
I 2 of 5 Set Length 2	50		142
<b>INTERLEAVED 2 of 5, FEBRABAN FORMAT (Desk Models Only)</b>			
Interleaved 2 of 5, Febraban format Enable / Disable	Disable		143
<b>INTERLEAVED 2 of 5 CIP HR</b>			
Interleaved 2 of 5 CIP HR Enable/Disable	Disable		144
<b>MATRIX 2 of 5</b>			
Matrix 2 of 5 Enable/Disable	Disable		145
Matrix 2 of 5 Check Character Calculation	Enable		145
Matrix 2 of 5 Check Character Transmission	Don't Send		146
Matrix 2 of 5 Length Control	Variable Length		146
Matrix 2 of 5 Set Length 1	8 characters		147
Matrix 2 of 5 Set Length 2	50 characters		147
<b>STANDARD 2 of 5</b>			
Standard 2 of 5 Enable/Disable	Disable		148
Standard 2 of 5 Check Character Calculation	Disble		148
Standard 2 of 5 Check Character Transmission	Send		149
Standard 2 of 5 Length Control	Variable Length		149
Standard 2 of 5 Set Length 1	08 (8 characters)		150
Standard 2 of 5 Set Length 2	50 (50 characters)		150
<b>COMPRESSED 2 of 5</b>			

PARAMETERS	DEFAULT	YOUR SETTING	PAGE NUMBER
Compressed 2 of 5 Enable/Disable	Disable		151
Compressed 2 of 5 Check Character Calculation	Disable		151
Compressed 2 of 5 Check Character Transmission	Send		152
Compressed 2 of 5 Length Control	Variable Length		152
Compressed 2 of 5 Set Length 1	1 character		153
Compressed 2 of 5 Set Length 2	50 characters		153
<b>DATALOGIC 2 OF 5</b>			
Datalogic 2 of 5 Enable/Disable	Disable		154
Datalogic 2 of 5 Check Character Calculation	Disable		154
Datalogic 2 of 5 Check Character Transmission	Send		155
Datalogic 2 of 5 Length Control	Variable Length		155
Datalogic 2 of 5 Set Length 1	6 characters		156
Datalogic 2 of 5 Set Length 2	50 characters		156
<b>INDUSTRIAL 2 of 5</b>			
Industrial 2 of 5 Enable/Disable	Disable		157
Industrial 2 of 5 Check Character Calculation	Disable		157
Industrial 2 of 5 Check Character Transmission	Send		158
Industrial 2 of 5 Length Control	Variable		158
Industrial 2 of 5 Set Length 1	6 characters		159
Industrial 2 of 5 Set Length 2	50 characters		159
<b>CODE IATA</b>			
IATA Enable/Disable	Disable		160
IATA Check Character Transmission	Send		160
<b>FOLLET 2 OF 5</b>			
Follett 2 of 5 Enable/Disable	Disable		161
<b>CODABAR</b>			
Codabar Enable/Disable	Disable		162

PARAMETERS	DEFAULT	YOUR SETTING	PAGE NUMBER
Codabar Check Character Calculation	Disable		162
Codabar Check Character Transmission	Send		163
Codabar Start/Stop Character Transmission	Transmit		163
Codabar Start/Stop Character Set	abcd/abcd		164
Codabar Start/Stop Character Match	Don't Require Match		164
Codabar Quiet Zones	Quiet Zones on two sides		165
Codabar Length Control	Variable		166
Codabar Set Length 1	3 characters		166
Codabar Set Length 2	50 characters		167
<b>ABC CODABAR</b>			
ABC Codabar Enable/Disable	Disable		168
ABC Codabar Concatenation Mode	Static		168
ABC Codabar Dynamic Concatenation Timeout	200 msec		169
ABC Codabar Force Concatenation	Disable		169
<b>ISBT-128</b>			
ISBT 128 Concatenation	Disable		170
ISBT 128 Concatenation Mode	Static		170
ISBT 128 Dynamic Concatenation Timeout	200 msec		171
ISBT 128 Force Concatenation	Disable		172
ISBT 128 Advanced Concatenation Options	Disable		172
<b>CODE 11</b>			
Code 11 Enable/Disable	Disable		173
Code 11 Check Character Calculation	Check C and K		173
Code 11 Check Character Transmission	Send		174
Code 11 Length Control	Variable		174
Code 11 Set Length 1	4 characters		175
Code 11 Set Length 2	50 characters		175

PARAMETERS	DEFAULT	YOUR SETTING	PAGE NUMBER
<b>CODE 93</b>			
Code 93 Enable/Disable	Disable		176
Code 93 Check Character Calculation	Enable Check C and K		176
Code 93 Check Character Transmission	Disable		177
Code 93 Length Control	Variable		177
Code 93 Set Length 1	1 character		178
Code 93 Set Length 2	50 characters		178
Code 93 Quiet Zones	Auto		179
<b>MSI</b>			
MSI Enable/Disable	Disable		180
MSI Check Character Calculation	Calculate Mod 10		180
MSI Check Character Transmission	Send		181
MSI Length Control	Variable		181
MSI Set Length 1	1 character		182
MSI Set Length 2	50 characters		182
<b>PLESSEY</b>			
Plessey Enable/Disable	Disable		183
Plessey Check Character Calculation	Plessey std check char. verification		183
Plessey Check Character Transmission	Send		184
Plessey Length Control	Variable		184
Plessey Set Length 1	1 character		185
Plessey Set Length 2	50 characters		185
<b>BC412</b>			
BC412 Enable/Disable	Disable		186
BC412 Check Character Calculation	Calculate		186
BC412 Length Control	Variable		187
BC412 Set Length 1	1 character		188
BC412 Set Length 2	50 characters		188
<b>CODE SELECTION - 2D SYMBOLOGIES</b>			
2D Maximum Decoding Time	350 msec		191

PARAMETERS	DEFAULT	YOUR SETTING	PAGE NUMBER
2D Structured Append	Disable		192
2D Normal/Inverse Symbol Control	Normal		192
<b>AZTEC CODE</b>			
Aztec Code Enable / Disable	Enable		193
Aztec Code Length Control	Variable		193
Aztec Code Set Length 1	1 character		192
Aztec Code Set Length 2	3,832 characters		194
<b>CHINA SENSIBLE CODE</b>			
China Sensible Code Enable / Disable	Disable		195
China Sensible Code Length Control	Variable		195
China Sensible Code Set Length 1	1 character		196
China Sensible Code Set Length 2	7,827 characters		196
<b>DATA MATRIX</b>			
Data Matrix Enable / Disable	Enable		197
Data Matrix Square/Rectangular Style	Both Square and Rectangular Style		197
Data Matrix Length Control	Variable		198
Data Matrix Set Length 1	1 character		198
Data Matrix Set Length 2	3,116 characters		199
<b>GS1 DOTCODE</b>			
DotCode Enable	Disable		200
DotCode High Resolution Enable	Enable		200
DotCode Position-based Decoding	Disable		201
<b>MAXICODE</b>			
Maxicode Enable / Disable	Disable		202
Maxicode Primary Message Transmission	Disable		202
Maxicode Length Control	Variable		203
Maxicode Set Length 1	1 character		203
Maxicode Set Length 2	0145 characters		204
<b>PDF417</b>			



PARAMETERS	DEFAULT	YOUR SETTING	PAGE NUMBER
PDF417 Enable / Disable	Enable		205
PDF417 Length Control	Variable		205
PDF417 Set Length 1	1 character		206
PDF417 Set Length 2	2,710 characters		206
<b>MICRO PDF417</b>			
Micro PDF417 Enable / Disable	Enable		207
Micro PDF417 Code 128 GS1-128 Emulation	Micro PDF AIM ID and label type		207
Micro PDF417 Length Control	Variable		208
Micro PDF417 Set Length 1	1 character		208
Micro PDF417 Set Length 2	0366 characters		209
<b>QR CODE</b>			
QR Code Enable / Disable	Enable		210
QR Code Length Control	Variable		210
QR Code Set Length 1	1 character		211
QR Code Set Length 2	7,089 characters		211
<b>MICRO QR CODE</b>			
Micro QR Code Enable / Disable	Enable		212
Micro QR Code Length Control	Variable		212
Micro QR Code Set Length 1	1 character		213
Micro QR Code Set Length 2	0035 characters		213
<b>UCC COMPOSITE</b>			
UCC Optional Composite Timer	Timer Disabled		214
Postal Code Selection	Disable All Postal Codes		215
Postnet BB Control	Disable		216
<b>MOTION FEATURES</b>			
Motionless Timeout	2 seconds		220
Motion Sensitivity	Medium		220
High Motion Immunity	Disable		221
Motion Aiming Control	Enable		221
DOF Enhancement	Disable		222

## DEFAULT EXCEPTIONS

Table 27 - Default Exceptions by Interface Type

PARAMETER	DEFAULT EXCEPTION
<b>Interfaces: USB-OEM</b>	
Global Suffix	No Global Suffix
Double Read Timeout	500 msec
<b>Interfaces: All Keyboard Wedge, USB Keyboard</b>	
No unique settings	
<b>Interface: RS232-WN</b>	
Expand UPC-A to EAN-13	Enable
UPC-E Check Character Transmission	Disable
Parity	Odd Parity
Handshaking Control	RTS/CTS
Transmission Label ID Code	Prefix
GS1-128 AIM ID	Disable
UPCE Label ID Character(s)	C
EAN 8 Label ID Character(s)	B
EAN 13 Label ID Character(s)	A
Code ISBN Label ID Character(s)	A
Code 39 Label ID Character(s)	M
MInterleaved 2of5 Label ID Character(s)	I
Code Standard 2/5 Label ID Character(s)	H
Codabar Label ID Character(s)	N
Code 128 Label ID Character(s)	K
GS1-128 Label ID Character(s)	P
Datalogic 2 of 5 Label ID Character(s)	H
ISBT 128 Label ID Character(s)	K
UPCE P2 Label ID Character(s)	C
UPCE/P5 Label ID Character(s)	C
UPCE/GS1-128 Label ID Character(s)	C
EAN8/P2 Label ID Character(s)	B
EAN8/P5 Label ID Character(s)	B
EAN8/GS1-128 Label ID Character(s)	B
EAN13/P2 Label ID Character(s)	A
EAN13/P5 Label ID Character(s)	A
EAN13/GS1-128 Label ID Character(s)	A

PARAMETER	DEFAULT EXCEPTION
GS1 DataBar 14 (Omnidirectional) Label ID Character(s)	E
GS1 DataBar Expanded Label ID Character(s)	E
GS1 DataBar Limited Label ID Character(s)	E
Character Conversion	CR to `
<b>Interface: RS232-OPOS</b>	
Baud Rate	115200 Baud
Transmission Label ID Code	Prefix
GS1-128 AIM ID	Disable
UPCA Label ID Character(s)	C
UPCE Label ID Character(s)	D
EAN 8 Label ID Character(s)	A
EAN 13 Label ID Character(s)	B
Code ISBN Label ID Character(s)	@
Code 39 Label ID Character(s)	V
Code 32 Label ID Character(s)	X
Interleaved 2of5 Label ID Character(s)	N
Code Standard 2/5 Label ID Character(s)	P
Codabar Label ID Character(s)	R
Code 11 Label ID Character(s)	b
Code 128 Label ID Character(s)	T
GS1-128 Label ID Character(s)	k
UPCA/P2 Label ID Character(s)	F
UPCA/P5 Label ID Character(s)	G
UPCA/GS1-128 Label ID Character(s)	Q
UPCE P2 Label ID Character(s)	H
UPCE/P5 Label ID Character(s)	I
EAN8/P2 Label ID Character(s)	J
EAN8/P5 Label ID Character(s)	K
EAN8/GS1-128 Label ID Character(s)	*
EAN13/P2 Label ID Character(s)	L
EAN13/P5 Label ID Character(s)	M
EAN13/GS1-128 Label ID Character(s)	#
GS1 DataBar 14 (Omnidirectional) Label ID Character(s)	u
GS1 DataBar Expanded Label ID Character(s)	t
GS1 DataBar Limited Label ID Character(s)	v

# APPENDIX C

## SAMPLE BARCODES

---

The sample bar codes in this appendix are typical representations for their symbology types.

### SAMPLE BARCODES

#### 1D Barcodes

**UPC-A**

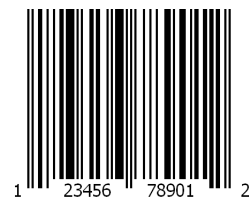

**EAN-13**



**Code 39**



**Code 128**



**Interleaved 2 of 5**



**Code 32**



**Codabar**



**Code 93**



**Code 11**



## GS1 Databar™ (RSS)

GS1 DataBar™ variants must be enabled to read the barcodes below (see "GS1 DataBar™ Omnidirectional" on page 119).

### GS1 DataBar™ Expanded Stacked



10293847560192837465019283746029478450366523

### GS1 DataBar™ Expanded



1234890hjjio9900mnb

### GS1 DataBar™ Limited



08672345650916

## GS1 Databar™ (-14)

### GS1 DataBar™ Omnidirectional Truncated



55432198673467

### GS1 DataBar™ Omnidirectional Stacked



90876523412674

### GS1 DataBar™ Omnidirectional Stacked



78123465709811

## 2D Barcodes

**Aztec**



**Data Matrix**



**China Sensible**



**MaxiCode**

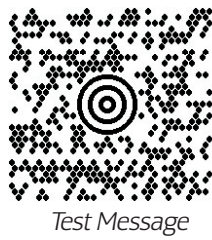

**PDF417**



ABCabc

**Micro PDF 417**



BV17453

**QR Code**



35900G9

**2D Barcodes (continued)**

**Micro QR Code**



123456

**UCC Composite**





# APPENDIX D

## KEYPAD

---

Use the bar codes in this appendix to enter numbers as you would select digits/characters from a keypad.



1



2



3



4



5



6



7



1



2



3



4



5



6



7



8



9

# APPENDIX E

## SCANCODE TABLES

---

### CONTROL CHARACTER EMULATION

Control character emulation selects from different scancode tables as listed in this appendix. Each of the control character sets below are detailed by interface type in the tables. These apply to Wedge and USB Keyboard platforms.

**Control Character 00** : Characters from 00 to 0x1F are sent as control character Ctrl+Keys, special keys are located from 0x80 to 0xA1.

**Control Character 01** : Characters from 00 to 0x1F are sent as control character Ctrl+Capital Key, special keys are located from 0x80 to 0xA1.

**Control Character 02** : Special keys are located from 00 to 0x1F and characters from 0x80 to 0xFE are intended as an extended ASCII table (Microsoft Windows Codepage 1252 — see [page 287](#)).

### Single Press and Release Keys

In the following tables, Ar↓ means Alt right pressed and Ar↑ means Alt right released and so on. Definitions for other keys are Al (Alt left ), Cr (Control Right ) Cl (Control Left ) Sh (shift). This method can be used for combining Alt, Control or Shift with other keys.

Example: Consider a Control character set to 00. If AltRight+A is required before sending a label to the host, it could be done by setting three Prefix keys in this way: 0x99 0x41 0x9A.

# INTERFACE TYPE PC AT PS/2, USB-KEYBOARD OR USB-KEYBOARD FOR APPLE

Table 28. Scancode Set When Control Character is 00 or 01

	x0	x1	x2	x3	x4	x5	x6	x7	x8	x9	xA	xB	xC	xD	xE	xF
0x	NULL C+@	SOH C(S)+A	STX C(S)+B	ETX C(S)+C	EOT C(S)+D	ENQ C(S)+E	ACK C(S)+F	BEL C(S)+G	BS CAN C(S)+X	HT TAB EM C(S)+Y	LF C(S)+J SUB C(S)+Z	VT C(S)+K ESC Esc	FF C(S)+L FS C+]	CR Enter GS C+]	SO C(S)+N RS C+^	SI C(S)+O US C(S)+_
1x	DLE C(S)+P	DC1 C(S)+Q	DC2 C(S)+R	DC3 C(S)+S	DC4 C(S)+T	NAK C(S)+U	SYN C(S)+V	ETB C(S)+W								
2x	SP	!	"	#	\$	%	&	'	(	)	*	+	,	-	.	/
3x	0	1	2	3	4	5	6	7	8	9	:	;	<	=	>	?
4x	@	A	B	C	D	E	F	G	H	I	J	K	L	M	N	O
5x	P	Q	R	S	T	U	V	W	X	Y	Z	[	\	]	^	_
6x	,	a	b	c	d	e	f	g	h	i	j	k	l	m	n	o
7x	p	q	r	s	t	u	v	w	x	y	z	{		}	~	Del
8x	€	Sh↓	Sh↑	Ins	Ent (keyp)	F1	F2	F3	F4	F5	F6	F7	F8	F9	F10	F11
9x	F12	Home	End	Pg Up	Pg Dwn	↑	↓	←	→	Ar↓	Ar↑	Al↓	Al↑	Cl↓	Cl↑	Cr↓
Ax	Cr↑		'	<i>f</i>	"	...	†	‡	^	%	Š	<	Š	<	Œ	
Bx	°	±	²	³	'	μ	¶	·	,	ı	°	»	¼	½	¾	ı
Cx	À	Á	Â	Ã	Ä	Å	Æ	Ç	È	É	Ê	Ë	Ì	Í	Î	Ï
Dx	Ð	Ñ	Ò	Ó	Ô	Õ	Ö	×	Ø	Ù	Ú	Û	Ü	Ý	Þ	ß
Ex	à	á	â	ã	ä	å	æ	ç	è	é	ê	ë	ì	í	î	ï
Fx	ð	ñ	ò	ó	ô	õ	ö	÷	ø	ù	ú	û	ü	ý	þ	ÿ

Extended characters (sky blue) are sent through dedicated keys (when available in the selected country mode) or by using an Alt Mode sequence.

INTERFACE TYPE PC AT PS/2, USB-KEYBOARD OR USB-KEYBOARD FOR APPLE (CONTINUED)

Table 29. Scancode Set When Control Character is 02

	x0	x1	x2	x3	x4	x5	x6	x7	x8	x9	xA	xB	xC	xD	xE	xF
0x	Ar↓	Ar↑	Al↓	Al↑	Cl↓	Cl↑	Cr↓	Cr↑	BS	Tab	→	S+Tab	Enter Keypd	Enter	Ins	Pg Up
1x	Pg Dwn	Home	←	↓	↑	F6	F1	F2	F3	F4	F5	ESC	F7	F8	F9	F10
2x	Space	!	“	#	\$	%	&	'	(	)	*	+	,	-	.	/
3x	0	1	2	3	4	5	6	7	8	9	:	;	<	=	>	?
4x	@	A	B	C	D	E	F	G	H	I	J	K	L	M	N	O
5x	P	Q	R	S	T	U	V	W	X	Y	Z	[	\	]	^	_
6x	`	a	b	c	d	e	f	g	h	i	j	k	l	m	n	o
7x	p	q	r	s	t	u	v	w	x	y	z	{		}	~	Del
8x	€	‘	’	ƒ	”	…	†	‡	^	%∞	Š	◀	Š	◁	Œ	
9x		‚	“	“	”	•	—	—	~	™	š	▶	œ		ž	ÿ
Ax	NBSP	ı	ı	ı	ı	ı	ı	ı	ı	ı	ı	ı	ı	ı	ı	ı
Bx	°	±	²	³	´	µ	¶	·	¸	¹	º	»	¼	½	¾	¿
Cx	À	Á	Â	Ã	Ä	Å	Æ	Ç	È	É	Ê	Ë	Ì	Í	Î	Ï
Dx	Ð	Ò	Ó	Ô	Õ	Ö	Ø	×	Ù	Ú	Û	Ü	Ý	Þ	ß	
Ex	à	á	â	ã	ä	å	æ	ç	è	é	ê	ë	ì	í	î	ï
Fx	ð	ñ	ò	ó	ô	õ	ö	÷	ø	ù	ú	û	ü	ý	þ	ÿ

# INTERFACE TYPE PC AT PS/2 ALT MODE OR USB-KEYBOARD ALT MODE

Table 30. Scancode Set When Control Character is 00 or 01

	x0	x1	x2	x3	x4	x5	x6	x7	x8	x9	xA	xB	xC	xD	xE	Xf
0x	Alt+000	Alt+001	Alt+002	Alt+003	Alt+004	Alt+005	Alt+006	Alt+007	BS	HT TAB	Alt+010	Alt+011	Alt+012	CR Enter	Alt+014	Alt+015
1x	Alt+016	Alt+017	Alt+018	Alt+019	Alt+020	Alt+021	Alt+022	Alt+023	Alt+024	Alt+025	Alt+026	ESC Esc	Alt+028	Alt+029	Alt+030	Alt+031
2x	A+032	A+033	A+034	A+035	A+036	A+037	A+038	A+039	A+040	A+041	A+042	A+043	A+044	A+045	A+046	A+047
3x	A+048	A+049	A+050	A+051	A+052	A+053	A+054	A+055	A+056	A+057	A+058	A+059	A+060	A+061	A+062	A+063
4x	A+064	A+065	A+066	A+067	A+068	A+069	A+070	A+071	A+072	A+073	A+074	A+075	A+076	A+077	A+078	A+079
5x	A+080	A+081	A+082	A+083	A+084	A+085	A+086	A+087	A+088	A+089	A+090	A+091	A+092	A+093	A+094	A+095
6x	A+096	A+097	A+098	A+099	A+100	A+101	A+102	A+103	A+104	A+105	A+106	A+107	A+108	A+109	A+110	A+111
7x	A+112	A+113	A+114	A+115	A+116	A+117	A+118	A+119	A+120	A+121	A+122	A+123	A+124	A+125	A+126	A+127
8x	€	Sh↓	Sh↑	Ins	Ent (keyp)	F1	F2	F3	F4	F5	F6	F7	F8	F9	F10	F11
9x	F12	Home	End	Pg Up	Pg Dwn	↑	↓	←	→	Ar↓	Ar↑	Al↓	Al↑	Cl↓	Cl↑	Cr↓
Ax	Cr↑	A+0161	A+0162	A+0163	A+0164	A+0165	A+0166	A+0167	A+0168	A+0169	A+0170	A+0171	A+0172	A+0173	A+0174	A+0175
Bx	A+0176	A+0177	A+0178	A+0179	A+0180	A+0181	A+0182	A+0183	A+0184	A+0185	A+0186	A+0187	A+0188	A+0189	A+0190	A+0191
Cx	A+0192	A+0193	A+0194	A+0195	A+0196	A+0197	A+0198	A+0199	A+0200	A+0201	A+0202	A+0203	A+0204	A+0205	A+0206	A+0207
Dx	A+0208	A+0209	A+0210	A+0211	A+0212	A+0213	A+0214	A+0215	A+0216	A+0217	A+0218	A+0219	A+0220	A+0221	A+0222	A+0223
Ex	A+0224	A+0225	A+0226	A+0227	A+0228	A+0229	A+0230	A+0231	A+0232	A+0233	A+0234	A+0235	A+0236	A+0237	A+0238	A+0239
Fx	A+0240	A+0241	A+0242	A+0243	A+0244	A+0245	A+0246	A+0247	A+0248	A+0249	A+0250	A+0251	A+0252	A+0253	A+0254	A+0255

INTERFACE TYPE PC AT PS/2 ALT MODE OR USB-KEYBOARD ALT MODE (CONTINUED)

Table 31. Scancode Set When Control Character is 02

	x0	x1	x2	x3	x4	x5	x6	x7	x8	x9	xA	xB	xC	xD	xE	xF
0x	Ar↓	Ar↑	Al↓	Al↑	Cl↓	Cl↑	Cr↓	Cr↑	BS	Tab	→	S+ Tab	Enter Keypd	Enter	Ins	Pg Up
1x	Pg Dwn	Home	←	→	↑	F6	F1	F2	F3	F4	F5	ESC	F7	F8	F9	F10
2x	A+032	A+033	A+034	A+035	A+036	A+037	A+038	A+039	A+040	A+041	A+042	A+043	A+044	A+045	A+046	A+047
3x	A+048	A+049	A+050	A+051	A+052	A+053	A+054	A+055	A+056	A+057	A+058	A+059	A+060	A+061	A+062	A+063
4x	A+064	A+065	A+066	A+067	A+068	A+069	A+070	A+071	A+072	A+073	A+074	A+075	A+076	A+077	A+078	A+079
5x	A+080	A+081	A+082	A+083	A+084	A+085	A+086	A+087	A+088	A+089	A+090	A+091	A+092	A+093	A+094	A+095
6x	A+096	A+097	A+098	A+099	A+100	A+101	A+102	A+103	A+104	A+105	A+106	A+107	A+108	A+109	A+110	A+111
7x	A+112	A+113	A+114	A+115	A+116	A+117	A+118	A+119	A+120	A+121	A+122	A+123	A+124	A+125	A+126	A+127
8x	A+0128	A+0129	A+0130	A+0131	A+0132	A+0133	A+0134	A+0135	A+0136	A+0137	A+0138	A+0139	A+0140	A+0141	A+0142	A+0143
9x	A+0144	A+0145	A+0146	A+0147	A+0148	A+0149	A+0150	A+0151	A+0152	A+0153	A+0154	A+0155	A+0156	A+0157	A+0158	A+0159
Ax	A+0160	A+0161	A+0162	A+0163	A+0164	A+0165	A+0166	A+0167	A+0168	A+0169	A+0170	A+0171	A+0172	A+0173	A+0174	A+0175
Bx	A+0176	A+0177	A+0178	A+0179	A+0180	A+0181	A+0182	A+0183	A+0184	A+0185	A+0186	A+0187	A+0188	A+0189	A+0190	A+0191
Cx	A+0192	A+0193	A+0194	A+0195	A+0196	A+0197	A+0198	A+0199	A+0200	A+0201	A+0202	A+0203	A+0204	A+0205	A+0206	A+0207
Dx	A+0208	A+0209	A+0210	A+0211	A+0212	A+0213	A+0214	A+0215	A+0216	A+0217	A+0218	A+0219	A+0220	A+0221	A+0222	A+0223
Ex	A+0224	A+0225	A+0226	A+0227	A+0228	A+0229	A+0230	A+0231	A+0232	A+0233	A+0234	A+0235	A+0236	A+0237	A+0238	A+0239
Fx	A+0240	A+0241	A+0242	A+0243	A+0244	A+0245	A+0246	A+0247	A+0248	A+0249	A+0250	A+0251	A+0252	A+0253	A+0254	A+0255

# DIGITAL INTERFACE

Table 32. Scancode Set When Control Character is 00 or 01

	X0	X1	X2	X3	X4	X5	X6	X7	X8	X9	xA	xB	xC	xD	xE	xF
0x	NULL C+@	SOH C(S)+A	STX C(S)+B	ETX C(S)+C	EOT C+D	ENQ C(S)+E	ACK C(S)+F	BEL C(S)+G	BS	HT TAB	LF C(S)+J	VT C(S)+K	FF C(S)+L	CR Enter	SO C(S)+N	SI C(S)+O
1x	DLE C(S)+P	DC1 C(S)+Q	DC2 C(S)+R	DC3 C(S)+S	DC4 C(S)+T	NAK C(S)+U	SYN C(S)+V	ETB C(S)+W	CAN C(S)+X	EM C(S)+Y	SUB C(S)+Z	ESC Esc	FS C(S)+\	GS C+]	RS C(S)+^	US C(S)+_
2x	Space	!	“	#	\$	%	&	'	(	)	*	+	,	-	.	/
3x	0	1	2	3	4	5	6	7	8	9	:	;	<	=	>	?
4x	@	A	B	C	D	E	F	G	H	I	J	K	L	M	N	O
5x	P	Q	R	S	T	U	V	W	X	Y	Z	[	\	]	^	_
6x	,	a	b	c	d	e	f	g	h	i	j	k	l	m	n	o
7x	p	q	r	s	t	u	v	w	x	y	z	{		}	~	Del
8x		Sh↓	Sh↑	Ins	Ent (keyp)	F1	F2	F3	F4	F5	F6	F7	F8	F9	F10	F11
9x	F12	F13	F14	F15	F16	↑	↓	←	→					Cl↓	Cl↑	

Table 33. Scancode Set When Control Character is 02

	X0	X1	X2	X3	X4	X5	X6	X7	X8	X9	xA	xB	xC	xD	xE	xF
0x					Cl↓	Cl↑			BS	Tab	à	S+ Tab	Enter Keyprd	Enter	Ins	
1x			←	↓	↑	F6	F1	F2	F3	F4	F5	ESC	F7	F8	F9	F10
2x	Space	!	“	#	\$	%	&	'	(	)	*	+	,	-	.	/
3x	0	1	2	3	4	5	6	7	8	9	:	;	<	=	>	?
4x	@	A	B	C	D	E	F	G	H	I	J	K	L	M	N	O
5x	P	Q	R	S	T	U	V	W	X	Y	Z	[	\	]	^	_
6x	,	a	b	c	d	e	f	g	h	i	j	k	l	m	n	o
7x	p	q	r	s	t	u	v	w	x	y	z	{		}	~	Del



# IBM31XX 102-KEY

Table 34. Scancode Set When Control Character is 00 or 01

	x0	x1	x2	x3	x4	x5	x6	x7	x8	x9	xA	xB	xC	xD	xE	xF
0x	NULL C+@	SOH C(S)+A	STX C(S)+B	ETX C(S)+C	EOT C+D	ENQ C(S)+E	ACK C(S)+F	BEL C(S)+G	BS	HT TAB	LF C(S)+J	VT C(S)+K	FF C(S)+L	CR Enter	SO C(S)+N	SI C(S)+O
1x	DLE C(S)+P	DC1 C(S)+Q	DC2 C(S)+R	DC3 C(S)+S	DC4 C(S)+T	NAK C(S)+U	SYN C(S)+V	ETB C(S)+W	CAN C(S)+X	EM C(S)+Y	SUB C(S)+Z	ESC Esc	FS C(S)+\	GS C+]	RS C(S)+^	US C(S)+_
2x	Space	!	“	#	\$	%	&	'	(	)	*	+	,	-	.	/
3x	0	1	2	3	4	5	6	7	8	9	:	;	<	=	>	?
4x	@	A	B	C	D	E	F	G	H	I	J	K	L	M	N	O
5x	P	Q	R	S	T	U	V	W	X	Y	Z	[	\	]	^	_
6x	,	a	B	c	d	e	f	g	h	i	j	k	l	m	n	o
7x	p	q	R	s	t	u	v	w	x	y	z	{		}		Del
8x		Sh↓	Sh↑	Ins	Ent (keyp)	F1	F2	F3	F4	F5	F6	F7	F8	F9	F10	F11
9x	F12	Enter	Reset	Insert	Delete	Field -	Field +	Enter paddle	Printl	Ar↓	Ar↑	Al↓	Al↑	Cl↓	Cl↑	Cr↓
Ax	Cr↑															

Table 35. Scancode Set When Control Character is 02

	X0	X1	X2	X3	X4	X5	X6	X7	X8	X9	xA	xB	xC	xD	xE	xF
0x	Ar↓	Ar↑	Al↓	Al↑	Cl↓	Cl↑	Cr↓	Cr↑	BS	Tab	→	S+ Tab	Enter Keycpd	Enter	Ins	Pg Up
1x	Pg Dwn	Home	←	↓	↑	F1	F2	F3	F4	F5	ESC	F7	F8	F9	F10	
2x	Space	!	“	#	\$	&	,	(	)	*	+	,	-	.	/	
3x	0	1	2	3	4	6	7	8	9	:	;	;	<	=	>	?
4x	@	A	B	C	D	F	G	H	I	J	K	L	M	N	O	
5x	P	Q	R	S	T	V	W	X	Y	Z	[	\	]	^	_	
6x	,	a	B	c	d	f	g	h	i	j	k	l	m	n	o	
7x	p	q	R	s	t	v	w	x	y	z	{		}		Del	

# IBM XT

Table 36. Scancode Set When Control Character is 00 or 01

	x0	x1	x2	x3	x4	x5	x6	x7	x8	x9	xA	xB	xC	xD	xE	xF
0x	NULL C+@	SOH C(S)+A	STX C(S)+B	ETX C(S)+C	EOT C+D	ENQ C(S)+E	ACK C(S)+F	BEL C(S)+G	BS C(S)+H	HT TAB	LF C(S)+J	VT C(S)+K	FF C(S)+L	CR Enter	SO C(S)+N	SI C(S)+O
1x	DLE C(S)+P	DC1 C(S)+Q	DC2 C(S)+R	DC3 C(S)+S	DC4 C(S)+T	NAK C(S)+U	SYN C(S)+V	ETB C(S)+W	CAN C(S)+X	EM C(S)+Y	SUB C(S)+Z	ESC Esc	FS C(S)+\	GS C+]	RS C(S)+^	US C(S)+_
2x	Space	!	“	#	\$	%	&	'	(	)	*	+	,	-	.	/
3x	0	1	2	3	4	5	6	7	8	9	:	;	<	=	>	?
4x	@	A	B	C	D	E	F	G	H	I	J	K	L	M	N	O
5x	P	Q	R	S	T	U	V	W	X	Y	Z	[	\	]	^	_
6x	,	a	B	c	d	e	f	g	h	i	j	k	l	m	n	o
7x	p	q	R	s	t	u	v	w	x	y	z	{		}		Del
8x		Sh↓	Sh↑	Ins	Ent (keyp)	F1	F2	F3	F4	F5	F6	F7	F8	F9	F10	F11
9x	F12	Home	End	Pg Up	Pg Dwn	↑	↓	←	→	Ar↓	Ar↑	Alt↓	Alt↑	Cl↓	Cl↑	Cr↓
Ax	Cr↑															

Table 37. Scancode Set when Control Character 02

	X0	X1	X2	X3	X4	X5	X6	X7	X8	X9	xA	xB	xC	xD	xE	xF
0x	Ar↓	Ar↑	Al↓	Al↑	Cl↓	Cl↑	Cr↓	Cr↑	BS	Tab	→	S+Tab	Enter Keyypd	Enter	Ins	Pg Up
1x	Pg Dwn	Home	←	↓	↑	F6	F1	F2	F3	F4	F5	ESC	F7	F8	F9	F10
2x	Space	!	“	#	\$	%	&	‘	(	)	*	+	,	-	.	/
3x	0	1	2	3	4	5	6	7	8	9	:	;	<	=	>	?
4x	@	A	B	C	D	E	F	G	H	I	J	K	L	M	N	O
5x	P	Q	R	S	T	U	V	W	X	Y	Z	[	\	]	^	_
6x	,	a	B	c	d	e	f	g	h	i	j	k	l	m	n	o
7x	p	q	R	s	t	u	v	w	x	y	z	{		}		Del

## MICROSOFT WINDOWS CODEPAGE 1252

Windows-1252 is a character encoding of the Latin alphabet, used by default in the legacy components of Microsoft Windows in English and some other Western languages.

	00	01	02	03	04	05	06	07	08	09	0A	0B	0C	0D	0E	0F
00	NUL 0000	STX 0001	SOT 0002	ETX 0003	EOT 0004	ENO 0005	ACK 0006	BEL 0007	BS 0008	HT 0009	LF 000A	VT 000B	FF 000C	CR 000D	SO 000E	SI 000F
10	DLE 0010	DC1 0011	DC2 0012	DC3 0013	DC4 0014	NAK 0015	SYN 0016	ETB 0017	CAN 0018	EM 0019	SUB 001A	ESC 001B	PS 001C	GS 001D	RS 001E	US 001F
20	SP 0020	! 0021	" 0022	# 0023	\$ 0024	% 0025	& 0026	' 0027	( 0028	) 0029	* 002A	+ 002B	, 002C	- 002D	. 002E	/ 002F
30	0 0030	1 0031	2 0032	3 0033	4 0034	5 0035	6 0036	7 0037	8 0038	9 0039	: 003A	; 003B	< 003C	= 003D	> 003E	? 003F
40	@ 0040	A 0041	B 0042	C 0043	D 0044	E 0045	F 0046	G 0047	H 0048	I 0049	J 004A	K 004B	L 004C	M 004D	N 004E	O 004F
50	P 0050	Q 0051	R 0052	S 0053	T 0054	U 0055	V 0056	W 0057	X 0058	Y 0059	Z 005A	[ 005B	\ 005C	] 005D	^ 005E	_ 005F
60	` 0060	a 0061	b 0062	c 0063	d 0064	e 0065	f 0066	g 0067	h 0068	i 0069	j 006A	k 006B	l 006C	m 006D	n 006E	o 006F
70	p 0070	q 0071	r 0072	s 0073	t 0074	u 0075	v 0076	w 0077	x 0078	y 0079	z 007A	{ 007B	 007C	} 007D	~ 007E	DEL 007F
80	€ 20AC	• 2022	ƒ 201A	£ 0132	„ 201E	… 2026	† 2020	‡ 2021	ˆ 02C5	‰ 2030	Š 0160	< 2038	€ 0162	• 2022	ž 017D	• 2022
90	• 2022	ˆ 2020	˜ 2019	˘ 2018	• 2022	– 2013	— 2014	ˆ 02C5	‰ 2030	Š 0160	› 2039	€ 0162	• 2022	ž 017D	ÿ 0178	• 2022
A0	NESE 00A0	ı 00A1	ı 00A2	£ 00A3	× 00A4	¥ 00A5	ı 00A6	ı 00A7	ı 00A8	ı 00A9	ı 00AA	ı 00AB	ı 00AC	ı 00AD	ı 00AE	ı 00AF
B0	° 00B0	± 00B1	² 00B2	³ 00B3	´ 00B4	µ 00B5	¶ 00B6	· 00B7	¸ 00B8	¹ 00B9	º 00BA	» 00BB	¼ 00BC	½ 00BD	¾ 00BE	¿ 00BF
C0	À 00C0	Á 00C1	Â 00C2	Ã 00C3	Ä 00C4	Å 00C5	Æ 00C6	Ç 00C7	È 00C8	É 00C9	Ê 00CA	Ë 00CB	Ì 00CC	Í 00CD	Î 00CE	Ï 00CF
D0	Ð 00D0	Ñ 00D1	Ò 00D2	Ó 00D3	Ô 00D4	Õ 00D5	Ö 00D6	× 00D7	Ø 00D8	Ù 00D9	Ú 00DA	Û 00DB	Ü 00DC	Ý 00DD	Þ 00DE	ß 00DF
E0	à 00E0	á 00E1	â 00E2	ã 00E3	ä 00E4	å 00E5	æ 00E6	ç 00E7	è 00E8	é 00E9	ê 00EA	ë 00EB	ì 00EC	í 00ED	î 00EE	ï 00EF
F0	ø 00F0	ñ 00F1	ò 00F2	ó 00F3	ô 00F4	õ 00F5	ö 00F6	÷ 00F7	ø 00F8	ù 00F9	ú 00FA	û 00FB	ü 00FC	ý 00FD	þ 00FE	ÿ 00FF

# APPENDIX F

## ASCII CHART

---

ASCII Char.	Hex No.	ASCII Char.	Hex No.	ASCII Char.	Hex No.	ASCII Char.	Hex No.
NUL	00	SP	20	@	40	'	60
SOH	01	!	21	A	41	a	61
STX	02	"	22	B	42	b	62
ETX	03	#	23	C	43	c	63
EOT	04	\$	24	D	44	d	64
ENQ	05	%	25	E	45	e	65
ACK	06	&	26	F	46	f	66
BEL	07	'	27	G	47	g	67
BS	08	(	28	H	48	h	68
HT	09	)	29	I	49	i	69
LF	0A	*	2A	J	4A	j	6A
VT	0B	+	2B	K	4B	k	6B
FF	0C	,	2C	L	4C	l	6C
CR	0D	-	2D	M	4D	m	6D
SO	0E	.	2E	N	4E	n	6E
SI	0F	/	2F	O	4F	o	6F
DLE	10	0	30	P	50	p	70
DC1	11	1	31	Q	51	q	71
DC2	12	2	32	R	52	r	72
DC3	13	3	33	S	53	s	73
DC4	14	4	34	T	54	t	74
NAK	15	5	35	U	55	u	75
SYN	16	6	36	V	56	v	76
ETB	17	7	37	W	57	w	77
CAN	18	8	38	X	58	x	78
EM	19	9	39	Y	59	y	79
SUB	1A	:	3A	Z	5A	z	7A
ESC	1B	;	3B	[	5B	{	7B
FS	1C	<	3C	\	5C		7C
GS	1D	=	3D	]	5D	}	7D
RS	1E	>	3E	^	5E	~	7E
US	1F	?	3F	_	5F	DEL	7F

© 2021 Datalogic S.p.A. and /or its affiliates • All rights reserved • Without limiting the rights under copyright, no part of this documentation may be reproduced, stored in or introduced into a retrieval system, or transmitted in any form or by any means, or for any purpose, without the express written permission of Datalogic S.p.A. and/or its affiliates • Datalogic and the Datalogic logo are registered trademarks of Datalogic S.p.A. in many countries, including the U.S. and the E.U.



**Datalogic S.r.l.**

Via S. Vitalino, 13 | 40012 Calderara di Reno | Bologna - Italy  
Tel. +39 051 3147011 | Fax +39 051 3147205

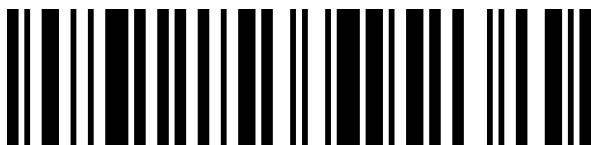

820120400

(Rev A)

March 2021