

RPP04

Mobile Label Printer

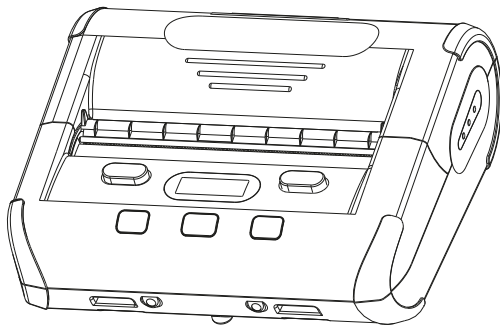

User Manual

Before using the printer
please read the manual carefully

Contents

Foreword.....	1	V, Setting.....	12
About this manual.....	1	5.1 Setting interface.....	12
International conventions.....	1	5.2 Self-test.....	13
Related manual information.....	1	5.3 Paper stripping function.....	14
Safety instruction.....	2	VI, Screen icons description.....	15
I, Standard accessories.....	5	VII, Communication.....	16
II, Appearance and components.....	6	7.1 USB communication.....	16
III, Preparation before using.....	8	7.2 WIFI communication.....	17
3.1 Battery installation.....	8	7.3 Bluetooth communication.....	17
3.2 Battery charging.....	9	VIII, Maintenance.....	18
3.3 Printing paper installation.....	10	8.1 Printer daily maintenance.....	18
IV, Basic using function.....	11	8.2 Printer usage and preservation.....	18
4.1 Power on.....	11	IX, Fault diagnosis.....	19
4.2 Power off.....	11	X, Appendix.....	20
4.3 Paper feeding.....	11	10.1 Printer parameters.....	20
4.4 Learning paper type automatically.....	11	10.2 Battery recycling.....	21
4.5 Automatic inactivity/wake-up.....	11		

Foreword



About this manual

Thank you for purchasing our company's **RPP04** mobile label printer.

This manual can help you to learn how to use this product easily. Before using, please read through this manual and safekeep it, in order that all the users of this product can read it.

Icons and convention

In order to let you be convenient to refer to information, this manual uses follows symbols (icons) and conventions:

-  **Warning** This symbol means warning. If it's used incorrectly, it may cause property loss, personal injury or dead.
-  **Attention** This symbol means paying attention. It may cause personnel injury or articles damage.
-  **Remark** This symbol means remark. Its listed information can make you use this product better or prolong product service life.

Related manual information

Following various manuals provide detailed description aiming at various technical questions.

RPP04 Product Specification provides detailed description for hardware/physical/technical parameters of this product.







Statement







This product is class A. In living environment, this product may cause radio interference.
Under this circumstance, user needs to adopt feasible measures for treating the interference.

 The illustrations and words in this manual may be different from actual condition. Please in kind prevail.





Safety Instruction







Please observe following matters when using printer:

-  **Attention** Please don't dismantle printer by yourself. Read this manual seriously before using.
-  **Warning** If fault appears, please turn off the power immediately. If you discover the printer or power adapter smokes or emit peculiar smell, please pluck off the power adapter immediately and take out battery. Pay attention to prevent be burned.
-  **Warning** Please don't use printer nearby petrol station, fuel warehouse and other inflammable products.
-  **Warning** During charging, the printer and power adapter shall be placed in ventilated position with ambient temperature of $-5^{\circ}\text{C}\sim 50^{\circ}\text{C}$. Please use power adapter provided by our company. Using unauthorized power adapter may cause danger, meanwhile, it violates our company's regulated warranty rules.
-  **Attention** Don't open paper carrier cover when printer is printing, otherwise, it may cause unexpected conditions or even damage printer.
-  **Attention** After is printing is finished, the print head is still under high-temperature condition, so please don't touch it to avoid be burned.
-  **Attention** Please don't use solute to scrub printer shell, such as benzene thinner, etc. Please don't use corrosive chemicals to touch with printer. Only clean soft cloth can be used to scrub the printer slightly.







-  **Attention** Please use our company's original or accepted printing paper, otherwise, it may cause bad printing quality even the damage of printing mechanism.
-  **Attention** If printer needs to be stored for long-term, please remove the battery from the compartment, otherwise, battery may lose efficacy.
-  **Attention** Before changing battery, please confirm that printer has been closed. If the power adapter is working, please confirm that the power is turned off during replacing battery.
-  **Attention** The stable working temperature for printer is 0°C~40°C. Higher or lower ambient temperature may decline printing quality.
-  **Attention** The preservation time of writing on receipt depends on the quality of thermal paper you use. If the receipt need to be last for long period ,please choose long-acting thermal paper.
-  **Attention** The printer is applicable to use in regions under 2000 meters and non-tropical zones.

When using battery, please follow the precautions below.

-  **Attention** Please read this user manual and sticker on battery carefully before using.
-  **Warning** Please charge battery in cool and ventilated indoor environment. High ambient temperature during charging may cause battery heating, smoking, burning or deformation, even explosion.
-  **Warning** There is circuit-protection device inside battery. Please don't dismantle battery by yourself , otherwise, it may cause short circuit or leakage of electrolyte.
-  **Warning** It may cause the risk of blindness if electrolyte enters into the eye. If it happens accidentally, please wash the eye with clean water and take a cure immediately





-  **Warning** It's strictly prohibited to press, mechanically vibrate or shake the battery in case of the short circuit.
-  **Warning** Please don't place the battery in the water in case of the short circuit, otherwise, it may cause the battery heating, smoking, deformation, damages, even the explosion.
-  **Attention** Please don't expose the battery under the sunshine or place the battery under the smoggy and dusty environment, such as bathroom.
-  **Attention** Please replace the battery when it can't meet basic performance requirements.
-  **Attention** Please put the battery in the locations out of children's reach in case of any danger.
-  **Attention** Please stop using the battery immediately if it discolors or gets deformed.

Before using, please read this manual and power adapter surface label seriously.

-  **Attention** Please don't dismantle or refit power adapter. It's prohibited to use power adapter if power cable is broken, otherwise, it may cause electric shock, burning or power adapter damage.
-  **Warning** Please don't touch power adapter with warm hands. If power adapter touches water or other liquid, please turn off power immediately.
-  **Warning** Please don't short-circuit, mechanically vibrate or shake power adapter.
-  **Warning** Please don't use power adapter in high-temperature locations, such as bath room. This equipment is not waterproof, so it's prohibited to make it get wet in the rain or be affected with damp.
-  **Warning** Please grasp power adapter nonmetallic part when pulling out plugs. It may damage electric wire to pull power cable merely.
-  **Attention** Please put power adapter in safe locations where children can't touch it in order to avoid dangers.

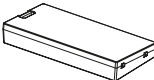
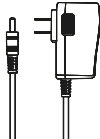
I , Standard Accessories ▶▶▶

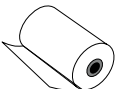
If any things are damaged or missing, please contact supplier.

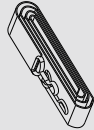
Standard Accessories			
			
RPP04 (1 set)	battery	power adapter	USB data cable
Standard Accessories			Optional Accessories
			
Label paper (1 roll)	warranty card (1 piece)	Users manual (1 piece)	Sling (1 role)

II , Appearance and components ▶▶▶

Front

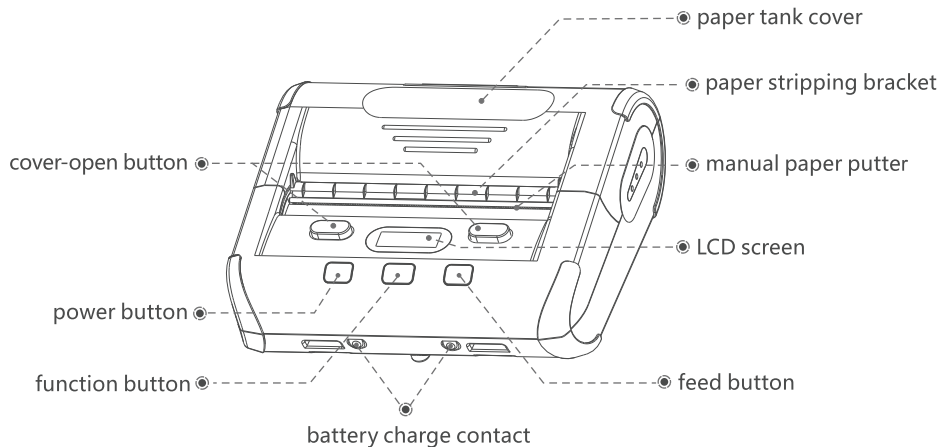

Interior

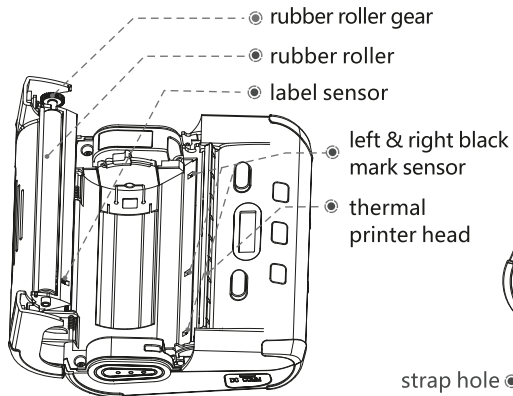

Reverse side

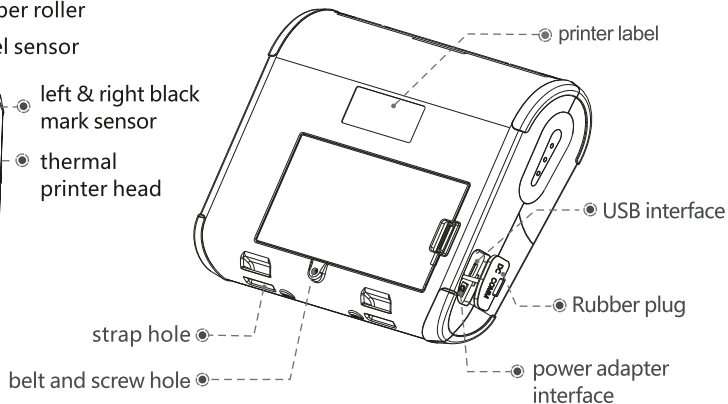

III, Preparation before using

This chapter introduces the preparation process before using, including installing battery, charging battery and installing printing papers.

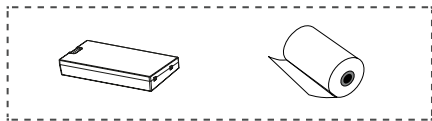

3.1 Battery installation

Before product leaving factory, battery has been installed in printer.

- 1.open protection film of battery contacts ;
- 2.install battery referring to above diagrams ;
- 3.fasten battery.

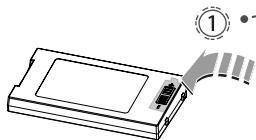

2

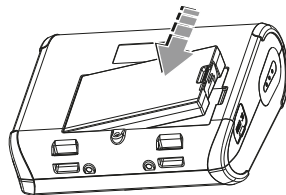

3

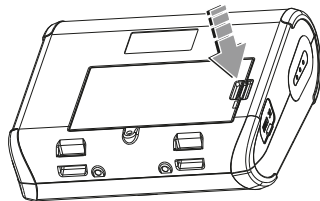

3.2 Battery charge

1、 Standby charge:

plug power adapter into power outlet, and plug DC plug into printer charging interface.

Charging: battery indication symbol "  " battery status bar scrolling displays.

Charging complete: The icon "  " indicates the battery is fully charged.

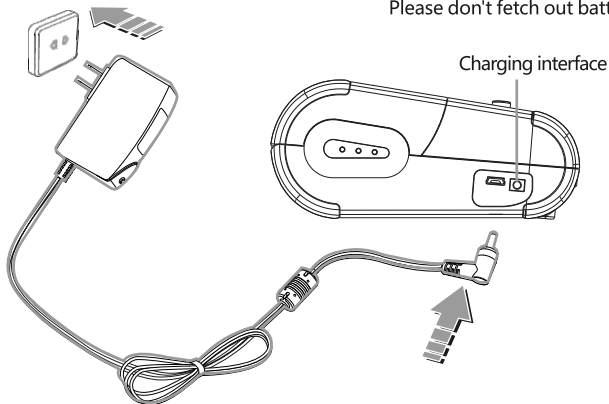

Warning.

If use power adapter that is not provided or accepted by our company, it may damage printer.

Remark

It can print during charging.

The device supports fast charging, which allows you to continue printing after a brief charge.

Attention

Please don't fetch out battery during charging.

3.3 printing paper roll installation

- 1 Take down the sealing tape on printing paper roll;
- 2 Press cover-open button and open paper tank;
- 3 Slide snap-gauge to adjust dimension of paper tank, then stir snap joint for fixing;
- 4 Put paper roll into paper tank;
- 5 Pull out a length of paper along with paper-out opening, then close paper tank cover.

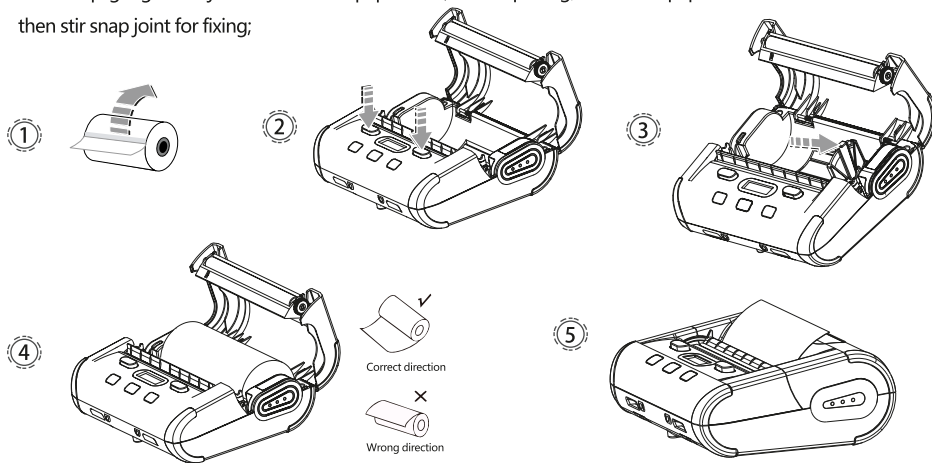

Remark: 1 Paper specification used by RPP04 printer is: paper width 110mm (single-side adjustable), paper roll diameter 50mm.

2 pay attention to direction of paper roll. If it's reversed, it may cause empty printing or non-process paper-feeding.

IV, Basic using function



4.1 Power on

Keep pressing printer power button for 3 seconds, then start printer.

4.2 Power off

Keep pressing printer power button for 3 seconds during starting up, then printer closes.

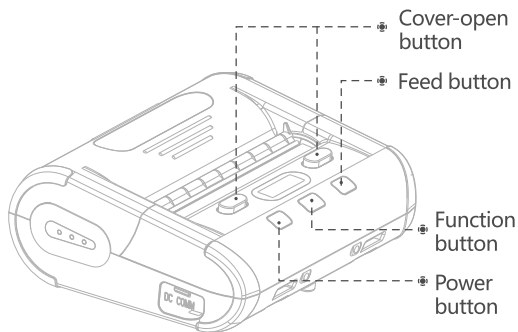

4.3 Paper feeding

Under continuous paper model, press Feed button "📄" then paper feeds for 5mm; under black mark paper/label paper model, press paper feeding button "📄", feed paper to black label position or the interval between the labels .

4.4 Learning paper type automatically

Long press Feed button "📄", learn paper types automatically.

4.5 Automatic dormant/ wake up

Automatic dormant:

when printer starts up, if there is no pressing operation or data transmission within 10 seconds, printer will enter into dormant status automatically. Screen displays as followed diagram.



Automatically wake up:

If printer is under dormant status, if press power button or printer receiving data will wake the printer up.

RPP04 has multifunctional LCD display. You can see the connection status and the battery status of printer, and it has more than 10 kinds of quick settings.

The print self-test page has functions as below:

1. Set language ;
2. Set paper type (label, continuation, black-label) ;
3. Test whether there is defective pixel ;
4. Set screensaver time ;
5. Set whether open paper peel or not ;
6. Select the width of paper.

5.1 Enter setting interface:

Long press set button to enter selection interface under on status (non-dormant status).

Press set button: enter to set next selection.

Press paper-feeding button: change option parameter.

Press power button: confirm set and quit.

5.2 self-test

Self-test page will list specific model of printer, allocation of communication interface and other contents.

Product Information

Selftest
Firmware Version:GD20x_V1.00 2017-5-1
Model:.....RPP04
Interface:.....USB
 & wifi
 & BlueTooth
Print Method:.....Direct Thermal
Print Density:.....9
Print Speed:..... 4
Font:.....24x24GB 18030
Media Type:..... Label
Instruction Set:..... TSC
Dpi:..... 203

Printing dimension parameter

Size:.....0 mm , 0mm
Reference:.....0mm , 0mm
Shift:..... 0mm
Offset:..... 0mm

Voltage, temperature

[POWER & DEGREE]
VOLTAGE:8.3 DEGREE:30

Bluetooth information

[Bluetooth Configure]
EDR NAME:.....RPP04-E
BLE NAME:.....RPP04-B
EDR PIN:.....0000
BLE PIN:.....000000
EDR ADD:.....00-00-15-01-B0-4C
BLE ADD:..... 00-01-15-01-B0-4C

WIFI information

[WIFI Configure]
WIFI SSID:.....12345678
Ethernet ID:.....41-38-30-31-35-37
DHCP:.....Disable
Ip address:.....192.168.1.87
Port:.....9100
NetMask:..... 255.255.255.0



Display interfaces of blue tooth version and Wifi version are different. Take actual display as standard.



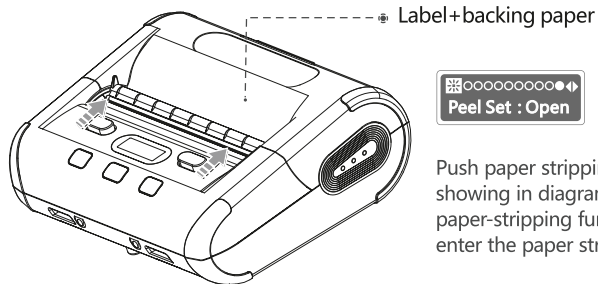

5.3 Paper stripping function

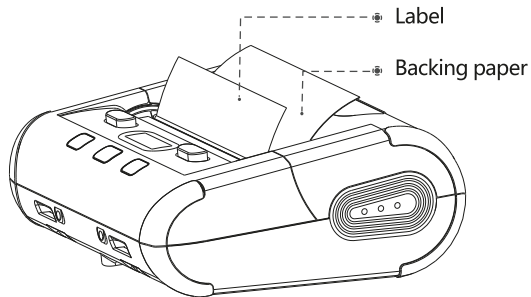

Push paper stripping bracket up as per showing in diagram and then open the paper-stripping function, which is to enter the paper stripping mode.



VI, Screen Icons Description »»

Printing status		This icon appears when printer is printing or feeding paper.
Paper out status	 Please fill printing papers	This icon appears when printer is out of paper or paper roll is not installed correctly.
Cover-opening status	Please close paper tank cover	This icon appears when paper tank cover is not closed or is closed incorrectly.
Battery indicator		During charging, this icon will jump the panes of sponges which means charging status.
Bluetooth indicator		Printer has bluetooth function. This icon appears.
Wireless indicator		Printer has wireless function. This icon appears. (√ means wifi is connected successfully.)

VII, Communication



7.1 USB communication

RPP04 provides Micro-USB interface, connect to PC as shown in diagram. Be able to charge printer, set parameter, transmit data, etc.

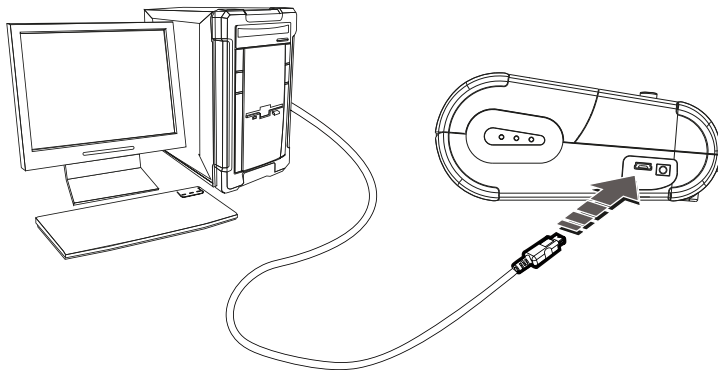

7.2 WIFI communication

RPP04 printer can provide Wifi communication, support STA model and TPIK/AES encryption. Effective communication distance is less than or equal to 20 meters.



 WIFI information can be set through setting tools. Please refer to Setting Tool Operation Introduction for details.

7.3 Blue tooth communication

- 1、RPP04 printer can provide bimodule Bluetooth 4.0 (SPP+BLE), and can conduct terminal communication with Android system and ISO system. Effect communication distance is less than or equal to 10 meters.
- 2、Support NFC quick connection pairing with bluetooth. (the phone with NFC function and APP post-touch connect)



 Bluetooth default pin code is 0000; parameters can be set through setting tools. Please refer to SettingTool Operation Introduction for details.

VIII, Maintenance



8.1 Printer daily maintenance

- 1、 Clean printer exterior and paper tank: please scrub printer surface and paper tank interior slightly with wringed wet cloth. Pay attention to that wet cloth must be wringed out completely.
- 2、 Clean printer mechanism: printer mechanism must be cleaned regularly, especially when printing quality decrease. Cleaning method is as follows: scrub printer mechanism surface spots and residual gum on label paper with degreasing cotton dipping with anhydrous alcohol until scrubbed clearly.
- 3、 If discover there is water in printer interior, please close printer and fetch out battery immediately and let printer dry naturally.
- 4、 If printer won't use for long-time, please fetch out battery and preserve it separately.

8.2 Printing paper usage and preservation

- 1、 New purchased printing paper shall avoid direct sunlight or preservation in high-temperature locations. Please don't tear packaging paper during preservation.
- 2、 The receipt after printing shall be preserved under condition of normal temperature (about 20°C) and lucifuge. This can prolong receipt preservation period effectively.
- 3、 If users need to preserve receipt for a long period, please select long-acting thermosensitive printing papers.

IX, Fault diagnosis



Fault phenomenon	Fault reason	Solution	Referring page
Printer only feeds paper during printing, and has no printing data.	Printing paper is installed upside down.	Change printing paper installation direction.	10
Printer prints blurrily	Printer movement is polluted due to long-term not being cleaned.	Movement needs to be cleaned.	18
	Printing paper coloration is not good.	Please set higher blackness or use printing paper with better coloration.	12
Printed receipt characters become fuzzy within several months or even several weeks.	Printing paper quality is not good.	Please use thermal printing paper with long retention period.	18
	Preservation temperature of receipt is too high.	Please preserve under normal temperature (about 20 °C)	18

10.1 Printer parameter

Printing parameter	
Printing method	Thermal line
Printing paper width	104mm
paper roll diameter	≤50mm
Printing speed	≤90mm/s
Paper stripping	Supportive
Resolution ration	203dpi
Font	GB 18030 (24x24)
Movement lifespan	50km (Label paper) 150km (Continuous papers)
Instruction set	TSC、CPCL、ESC/POS
Printing length	Larger than 200 meters (full charged, 12.5% printing density)
Printing content	Chinese, English, Russian etc., multi-languages One-dimensional bar code : UPC-A、UPC-E、CODE39、EAN-13、EAN-8、CODABAR、CODE128、CODE98、ITF Two-dimensional bar code : QR CODE

Printing parameter	
Battery specification	7.4V 2400mAh Lithium polymer battery
Charging period	1.5~2 hours
Wire communication	standard USB2.0
Wireless communication	Bimodule bluetooth: Bluetooth 4.0 (SPP+BLE) /WIFI
Appearance dimension	length 150mm, width 134mm, height 60mm
Weight	0.6kg
Operation environment	temperature 0°C~40°C / humidity : 20%~85%
Storage environment	temperature -20°C~70°C, humidity 5%~95%

10.2 Battery recycling

This product adopts Li-on rechargeable battery. In order to protect environment, please don't dispose waste battery at will. Supplier will provide battery recycling service for you.



