

User's Manual

Bar code Scanner v8.0.2



CONTENTS

Introduction	1
Auto-Introduction Barcode Scanner Operating Instruction	2
Appearance.....	4
Installing and Removing.....	4
Installing the interface cable.....	4
Removing the interface cable.....	5
Installing Keyboard Wedge Scanner	5
Installing RS-232C Interface Scanner.....	6
Installing USB interface scanner.....	7
Come Back Manufacture Setting.....	8
Display the Firmware Version.....	8
USB Mode.....	8
KBW Mode.....	8
RS-232 Mode.....	8
Multiscan Function	9
Scan Mode.....	9
Add Barcode ID.....	9
Buzzer.....	9
Interface-KBW.....	10
Transmit Speed.....	10
KBW language.....	10
Capital Key on and of.....	10
Interface-Serial-1.....	11
Baud Rate.....	11
Interface-Serial-2.....	12
handshake Protocol.....	12
Data Bit.....	12
Interface-Serial-3.....	13
Parity Check.....	13
Barcode Enable and Disable-1.....	14
CODE 11.....	14
CODE 39.....	14

CODE 39 FULL ASCII	14
CODE 93.....	14
CODE 128.....	14
Barcode Enable and Disable-2.....	15
MSI/Plessey.....	15
INTERLEAVE 2 OF 5.....	15
INDUSTRIAL 2 OF 5.....	15
CODABAR.....	15
CHINA POSTAL CODE.....	15
Barcode Enable and Disable-3.....	16
UPC/EAN.....	16
Barcode Symbol Set Up-1.....	17
CODE 11.....	17
CODE 39.....	17
Barcode Symbol Set Up-2.....	18
CODE 93.....	18
CODE 128.....	18
MSI/Plessey.....	18
Barcode Symbol Set Up-3.....	19
INTERLEAVE 2 OF 5.....	19
INDUSTRIAL 2 OF 5.....	19
CODABAR.....	19
Barcode Symbol Set Up-4.....	20
CODABAR.....	20
UPC/EAN.....	20
Barcode Symbol Set Up-5.....	21
UPC/EAN.....	21
Barcode Symbol Set Up-6.....	22
UPC/EAN.....	22
Edit and Set Up Brcode -1.....	23
Edit and Set Up Brcode -2.....	24
Macro/Spacial Key Set Up Barcode.....	25
Termination String Setup Barcode.....	26
Advanced Setting Mode -1.....	27

Prefix.....	27
Advanced Setting Mode -2	28
Suffix.....	28
Advanced Setting Mode -3	29
Truncate Header Character.....	29
Advanced Setting Mode -4	30
Truncate Trailer Character.....	30
Appendix.....	31
Appendix A: Full ASCII Table.....	31
Appendix B: Troubleshooting and Error Beeps.....	45

Introduction

Barcode devices provide an accurate, easy, and fast method of data entry and data storage for computerized information system.

The products we offer have another technology of infrared automatic sensor. User only need to put the barcode into sensing area which in front of window, 650nm laser will be automatic activated. Then aimed at the barcode which need to scan, the scanner scan automatically, the information will transmit to the host computer system.

There are two mode for this produce: handheld and automatic sensing laser barcode scanner. That means user can use it by handheld mode or can use as the fixation with the bracket-held.

The products we are offering now can be integrated into any host computer system by the following ways:

Keyboard

Wand

RS-232

Dual RS-232

USB

OTHERS

All the operating parameters are programmed by barcode programming menu and stored in non-volatile RAM which can retain the settings after power is turned off.

For the function which are not listed in this menu, please consult your supplier for more details.

*All rights reserved, including those to reprint this manual.

Auto-introduction Barcode Scanner Operating Instructions

1. The default scan mode of this scanner is auto induction scan mode. It start to scan in 2 seconds, when the object is close to the scanner. (Figure 1)

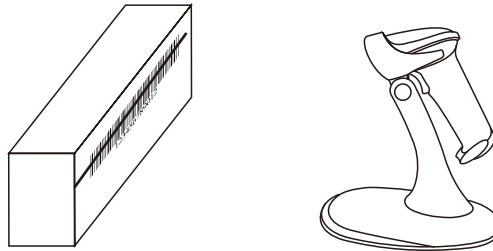

(Figure 1)

2. Press the button for 8 seconds, the user can switch the scanner mode between auto induction mode and manual trigger mode. (Figure 2)

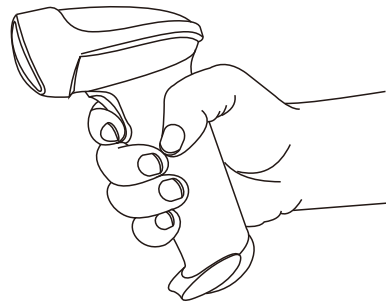

(Figure 2)

3. The auto induction distance is 15-20CM. (Figure 3)

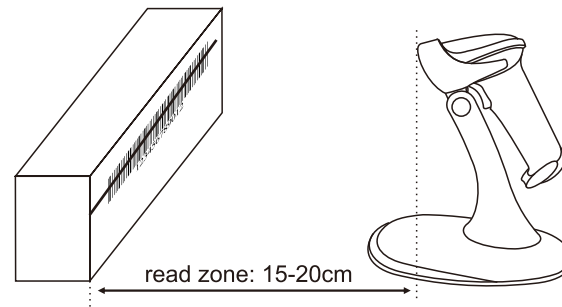

(Figure 3)

4. Make sure there is no baulk on the induction zone in front of the windows of scanner. If reading successful or can not reading in certain time, the scanner will auto-off laser.

5. When the laser close, Pls. Move the object from the induction zone, then the user can start to scan for next time.

Appearance

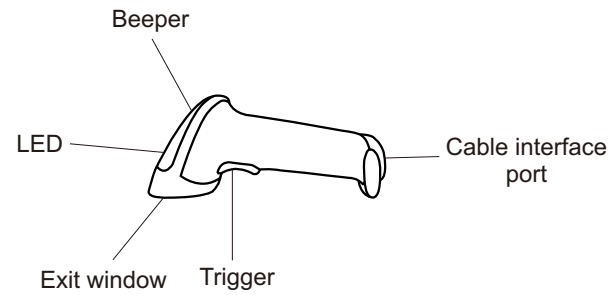

(Figure 1)

Installing and Removing

Installing the interface cable

1. Plug the cable's Rj45 port into the bottom of the scanner.
(Figure 2)
2. Connect the other end of the interface cable to the host.

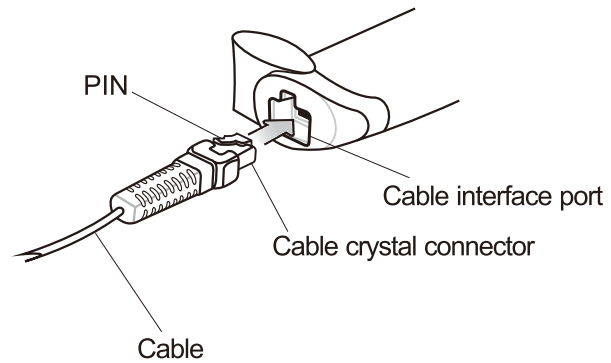

(Figure 2)

Removing the interface cable

1. Unplug the installing cable's modular connector by depressing the connector clip with the tip of a screwdriver.
2. Carefully slide out the cable.
3. Follow the step for installing the interface cable on page 5-7 to connect a new cable.

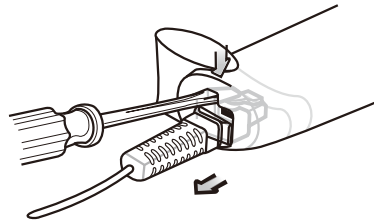

(Figure 3)

Installing keyboard wedge scanner

1. Make sure that the scanner has the correct cable for your system.
2. Turn off the power of the system.
3. Unplug the keyboard from the system.
4. Connect Y cable to the system and keyboard.
5. Turn on the power of the system.
6. If the indicator LED light up, buzzer sounds, the scanner is ready for reading.

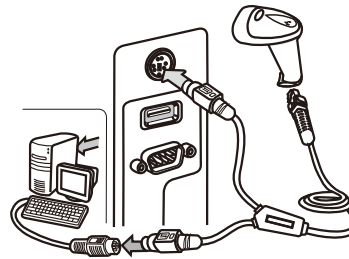

(Figure 4)

Installing RS-232C interface scanner

1. Make sure there is power supply for the scanner.
2. Connect the cable to the RS-232C port of the device.

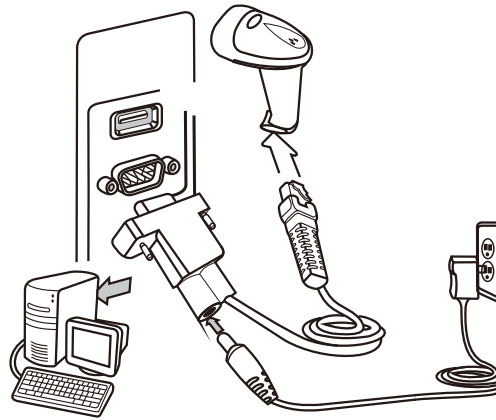

(Figure 5)

Installing USB interface scanner

Connect two ends, Windows will detect automatically.

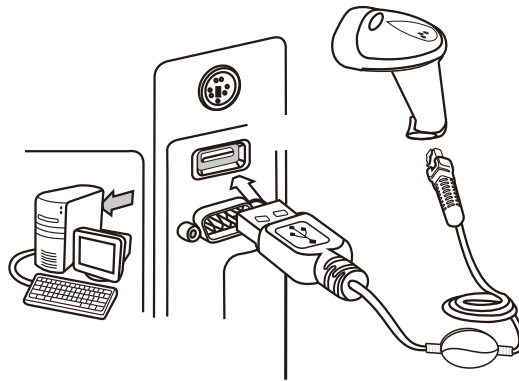

(Figure 6)



Come back manufacturer setting

**Note: all the parameters will come back to the manufacturer initial setting
(* denotes default setting)**



Display the firmware version



USB mode



KBW mode*



RS-232 mode

Multiscan Function

Scanning Mode



Reset*



Single scan no trigger



Multiscan



Multiscan no trigger



Automatic continue
scan



Automatic twinkle

Add Barcode ID



Before open barcode
to add ID



Before close barcode
to add ID



After open barcode
to add ID



After close barcode
to add ID

Buzzer

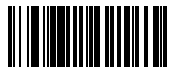

Mute



Turn on

Interface - KBW

Language



USA*



German



France



Reset

Capital Key On and Off



Reset*



Capital key on



Capital key off

Interface - Serial - 1

Baud Rate



600



1200



2400



4800



9600*



19200



38400



57600



115200



None

Interface - Serial - 2

Handshake Protocol



None*



Xon / Xoff



RTS / CTS



ACK / NAK



Handshake timeout
2 seconds

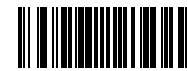

Handshake timeout
5 seconds

Data Bit



7 data bits



8 data bits*

Stop Bit



1 stop bit*



2 stop bits

Interface - Serial - 3

Parity Check



None*



Odd



Even



Mark



Space



Reset

Barcode Enable/Disable -1



Code 11 enable*

CODE 11



Code 11 disable



Code 39 enable*

CODE 39



Code 39 disable

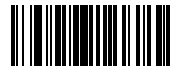

CODE 39 FULL ASCII
enable*

CODE 39 FULL ASCII



CODE 39 FULL ASCII
disable



Code 93 enable*

CODE 93



Code 93 disable



Code 128 enable*

CODE 128



Code 128 disable



Code 128 ISBT
enable*



Code 128 ISBT
disable

Barcode Enable/Disable -2

MSI/PLESSEY



MSI enable*



MSI disable

INTERLEAVE 2 OF 5



Interleave 2 of 5
enable*



Interleave 2 of 5
disable

INDUSTRIAL 2 OF 5



Industrial 2 of 5
enable*



Industrial 2 of 5
disable

MATRIX 2 OF 5



Matrix 2 of 5
enable*



Matrix 2 of 5
disable

CODABAR



Codabar enable*



Codabar disable

CHINA POSTAL CODE



China postal code
enable*



China postal code
disable

Barcode Enable/Disable -3

UPC/EAN



UPC-A enable*



UPC-A disable



UPC-E enable*



UPC-E disable



EAN-13 enable*



EAN-13 disable



EAN-8 enable*



EAN-8 disable

Barcode Symbol Set Up -1

CODE 11



Code 11 ID chars - 'm'



Code 11 ID chars - 'z'



Code 11 redundancy
enable



Code 11 redundancy
disable

CODE 39



Code 39 SS chars - none



Code 39 SS chars - '+'



Code 39 start/end chars
enable



Code 39 start/end chars
disable*



Code 39 ID chars - 'a'

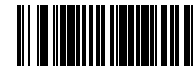

Code 39 ID chars - 'z'



Code 39 redundancy
enable



Code 39 redundancy
disable

Barcode Symbol Set Up -2

CODE 93



Code 93 ID chars - 'h'



Code 93 ID chars - 'z'



Code 93 redundancy
enable



Code 93 redundancy
disable

CODE 128



Code 93 ID chars - 'g'



Code 93 ID chars - 'z'



Code 128 redundancy
enable



Code 128 redundancy
disable

MSI/PLESSEY

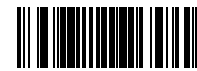

MSI ISBN ID chars - 'f'

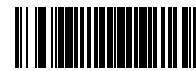

MSI ISBN ID chars - 'z'



MSI redundancy
enable



MSI redundancy
disable

Barcode Symbol Set Up -3

INTERLEAVE 2 OF 5



Interleave 2 of 5
ID chars - 'i'



Interleave 2 of 5
ID chars - 'z'



Interleave 2 of 5
redundancy enable



Interleave 2 of 5
redundancy disable

INDUSTRIAL 2 OF 5



Industrial 2 of 5
ID chars - 'j'



Industrial 2 of 5
ID chars - 'z'



Industrial 2 of 5
redundancy enable



Industrial 2 of 5
redundancy disable

CODABAR



Codabar start/end chars
enable



Codabar start/end chars
disable*



Codabar ID chars - 'k'



Codabar ID chars - 'z'

Barcode Symbol Set Up -4

CODABAR



Codabar space enable



Codabar space disable



Codabar redundancy
enable



Codabar redundancy
disable

UPC/EAN



UPC-E convert to UPC-A
enable



UPC-E convert to UPC-A
disable*



UPC-A convert to EAN-13
enable



UPC-A convert to EAN-13
disable*



EAN-13 convert to ISBN
enable



EAN-13 convert to ISBN
disable*



UPC-A ID chars - 'b'



UPC-A ID chars - 'z'

Barcode Symbol Set Up -5

UPC/EAN



EAN-13 ID chars - 'c'



EAN-13 ID chars - 'z'



EAN-13 ID chars - 'e'

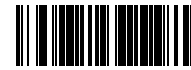

EAN-13 ID chars - 'z'

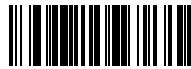

EAN-8 ID chars - 'd'

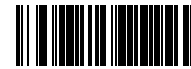

EAN-8 ID chars - 'z'



ISBN ID chars - 'f'

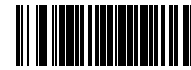

ISBN ID chars - 'z'



UPC/EAN redundancy
enable



UPC/EAN redundancy
disable



UPC/EAN supplements
- 2 digits



UPC/EAN supplements
- 5 digits

Barcode Symbol Set Up -6



UPC/EAN supplements
- 2 & 5 digits

UPC/EAN



UPC/EAN supplements
disable*

Edit and Set Up Brcode -1



Edit #1 - strip 1 leading character on all barcodes that start with '12345'



Reset



Edit #2 - strip the first character barcode



Reset



Edit #2 - strip the last character barcode



Reset



Edit #1 - filter leading spaces



Reset



Edit #1 - filter trailing spaces



Reset



Edit #1 - filter all '-' character



Reset

Edit and Set Up Brcode -2



Edit - insert leading '0'



Reset

Macro/Spacial Key Set Up Barcode



Macro #1 - find '1' and
replace with 'ONE'



Reset



Macro #1 - find '2' and
replace with 'TWO' for code 39



Reset



Macro #1 - find '0' and
replace with 'A'



Reset



Macro #1 - find 'F3' and
replace with '0'



Reset



Macro #1 - find 'ENTER' and
replace with '2'



Reset

Termination String Setup Barcode



String #1 -termination char -CR



String #1 -termination char -LF



String #1 -termination char
-CR+LF



String #1 disable



String #2 -Code 128
termination -CR



String #2 -Code 128
termination -LF



String #2 -Code 128
termination -CR+LF



String #2 -Code 128
termination removed



String -Code 39 termination
-TAB



String -Code 39 termination
-TAB removed



String -all codes preamble
- 'STX'



String -all codes postamble
- 'ETX'

Advanced Setting Mode -1

Prefix

1. Scan "Prefix" label



Prefix

2. Scan the characters label from the Full ASCII Code Table.

Ex: Prefix "MG" before data is required, scan "M" "G" label.



M



G

The "MG" will be added before the barcode.



TEST

Scan the "TEST" barcode, will be "MGTEST".

Advanced Setting Mode -2

Suffix

1. Scan "Suffix" label



Suffix

2. Scan the characters label from the Full ASCII Code Table.

Ex: Suffix "OK" before data is required, scan "O" "K" label.



O



K

The "OK" will be added after the barcode.



TEST

Scan the "TEST" barcode, will be "TESTOK".

Advanced Setting Mode -3

Truncate Header Character

1. Scan "Truncate header character" label.



Truncate header character

2. Scan the number that you want to truncate from the Full ASCII Table.

Ex: Truncate 2 header characters, scan "\$02" label .



\$02
STX

There will 2 header character be truncated.



123456789

Scan the above, there will be "3456789".

Advanced Setting Mode -4

Truncate Trailer Character

1. Scan "Truncate trailer character" label.



Truncate trailer character

2. Scan the number that you want to truncate from the Full ASCII Table.

Ex: Truncate 3 trailer characters, scan "\$03" label .



\$03
ETX

There will 3 trailer character be truncated.



987654321

Scan the above, there will be "987654".

Appendix

Appendix A: Full ASCII Table



OC001
Prefix



OC002
Suffix



OC003
Truncate header character



OC004
Truncate trailer character



S00
NUL/SP



S01
SOH



S02
STX



S03
ETX



S04
EOT



S05
ENQ



S06
ACK



S07
BEL



S08
BS/Back Space



S09
HT/TAB



\$0A
LF



\$0B
VT



\$0C
FF



\$0D
CR/ENTER



\$0E
SO



\$0F
SI



\$10
DLE



\$11
DC1



\$12
DC2



\$13
DC3



\$14
DC4



\$15
NAK



\$16
SYN



\$17
ETB



S18
CAN



S19
EM



S1A
SUB



S1B
ESC/ESC



S1C
FS



S1D
GS



S1E
RS



S1F
US



S20
SP



S21
!



S22
/



S23
#



S24
\$



S25
%



\$26
&



\$27
'



\$28
(



\$29
)



\$2A
*



\$2B
+



\$2C
,



\$2D
-



\$2E
.



\$2F
/



\$30
0



\$31
1



\$32
2



\$33
3



\$34
4



\$35
5



\$36
6



\$37
7



\$38
8



\$39
9



\$3A
:



\$3B
;



\$3C
<



\$3D
=



\$3E
>



\$3F
?



\$40
@



\$41
A



\$42
B



\$43
C



\$44
D



\$45
E



\$46
F



\$47
G



\$48
H



\$49
I



\$4A
J



\$4B
K



\$4C
L



\$4D
M



\$4E
N



\$4F
O



\$50
P



\$51
Q



\$52
R



\$53
S



\$54
T



\$55
U



\$56
V



\$57
W



\$58
X



\$59
Y



\$5A
Z



\$5B
[



\$5C
\



\$5D
]



\$5E

^



\$5F

-



\$60

`



\$61

a



\$62

b



\$63

c



\$64

d



\$65

e



\$66

f



\$67

g



\$68

h



\$69

i



\$6A

j



\$6B

k



\$6C
l



\$6D
m



\$6E
n



\$6F
o



\$70
p



\$71
q



\$72
r



\$73
s



\$74
t



\$75
u



\$76
v



\$77
w



\$78
x



\$79
y



\$7A
z



\$7B
{



\$7C
|



\$7D
}



\$7E
~



\$7F
DEL



\$80
F1



\$81
F2



\$82
F3



\$83
F4



\$84
F5



\$85
F6



\$86
F7



\$87
F8



\$88
F9



\$89
F10



\$8A
F11



\$8B
F12



\$8C
L_SHIFT ON



\$8D
L_SHIFT OFF



\$8E
R_SHIFT ON



\$8F
R_SHIFT OFF



\$90
L_ALT ON



\$91
L_ALT OFF



\$92
R_ALT ON



\$93
R_ALT OFF



\$94
L_CTRL ON



\$95
L_CTRL OFF



\$96
R_CTRL ON



\$97
R_CTRL OFF



\$98
/(KP)



\$99
*(KP)



\$9A
-(KP)



\$9B
+(KP)



\$9C
.(KP)



\$9D
Enter(KP)



\$9E
0(KP)



\$9F
1(KP)



\$A0
2(KP)



\$A1
3(KP)



\$A2
4(KP)



\$A3
5(KP)



\$A4
6(KP)



\$A5
7(KP)



\$A6
8(KP)



\$A7
9(KP)



\$A8
Inert



\$A9
Delete



\$AA
Home



\$AB
End



\$AC
Page Up



\$AD
Page Down



\$AE
Up



\$AF
Down



\$B0
Left



\$B1
Right



SB2
6(KP)



SB3
Inert



SB4
Delete



SB5
Home



SB6
End



SB7
Page Up



SB8
Page Down



SB9
Up



SBA
Down



SBB
Left



SBC
Right



SBD



SBE
Num Lock



SBF
Caps Lock



SC0
Scroll Lock

Appendix B: Troubleshooting and Error Beeps

Problem: The LED without light, without buzz, without laser.

Cause: The power supply for scanner off, or the wire interface become flexible.

Solution: Check the power supply, make sure the power supply on work. Reconnect the scanner and the computer again by wire.

Problem: After scan, no data to be transmitted.

Cause: The scanners setup is incorrect.

Solution: Make sure the scanners setup is in the correct mode.

Problem: No power supply startup buzz when the interface reader connect to the computer.

Cause: The interface reader won't offer the power supply.

Solution: Use a direct with 5V to connect up.

Problem: After connect the interface scanner, no data transmit when reading the barcode.

Cause: Haven't setup the interface mode or communication agreement incorrect.

Solution: Setup the interface mode. Or reset the correct communication agreement.

Problem: The scanner reader is normal, but with buzz.

Cause: The incorrect setup, which setup in aponia.

Solution: Scan the barcode of the startup voice.

Problem: Scan some of the barcode with buzz, but without the buzz when scan other barcode which in the same mode system.

Cause: The barcode be damage or there some problems with the barcode printing.

Solution: Check the barcode whether be damaged with carefulness. And check other barcode to find whether there are different to the same barcode system. Check the printer mode. Changed the setup of printer.

Problem: Other complexion or can't read the barcode.

Solution: Close the computer, re-connect the barcode scanner with the computer and keyboard, then turn on the computer power supply and check it; if still couldn't solve the problem, please contact with the dealer of the company.